

FINITE ENERGY FOLIATIONS ON OVERTWISTED CONTACT MANIFOLDS

CHRIS WENDL

ABSTRACT. We develop a method for preserving pseudoholomorphic curves in contact 3-manifolds under surgery along transverse links. This makes use of a geometrically natural boundary value problem for holomorphic curves in a 3-manifold with stable Hamiltonian structure, where the boundary conditions are defined by 1-parameter families of totally real surfaces. The technique is applied here to construct a finite energy foliation for every closed overtwisted contact 3-manifold.

CONTENTS

1. Introduction	2
1.1. Definitions and main result	2
1.2. Outline of the proof	8
1.3. Discussion	11
2. A mixed boundary value problem	12
3. Compactness	17
3.1. The setup	17
3.2. Deligne-Mumford theory with boundary	19
3.3. Preparation and removal of singularities	23
3.4. Taming forms and energy bounds	26
3.5. Bubbling	27
3.6. Convergence of conformal structures	33
3.7. Degeneration at the boundary	41
3.8. Convergence at the punctures	48
4. The main construction	50
4.1. Surgery and Lutz twists on transverse links	50
4.2. Some simple foliations in $S^1 \times \mathbb{R}^2$	55
4.3. Surgery on a holomorphic open book	66
4.4. Lifting to general closed braids	72
References	75

1. INTRODUCTION

1.1. Definitions and main result. Finite energy foliations of contact 3-manifolds were introduced by Hofer, Wysocki and Zehnder in [HWZ03], where they were shown to exist for generic tight three-spheres, giving powerful consequences for the Reeb dynamics. The present work is a step toward generalizing such existence results: we prove that for every closed overtwisted contact 3-manifold, one can choose a contact form (of Morse-Bott type) and compatible complex multiplication such that a stable finite energy foliation exists.

Fix a closed oriented 3-manifold M with a cooriented, positive contact structure ξ : this is by definition the kernel of a smooth 1-form λ which satisfies $\lambda \wedge d\lambda > 0$. The choice of contact form defines the *Reeb vector field* X by the conditions

$$d\lambda(X, \cdot) \equiv 0 \quad \text{and} \quad \lambda(X) \equiv 1.$$

Then the flow of X preserves ξ , along with the symplectic vector bundle structure on $\xi \rightarrow M$ defined by $d\lambda$.

Recall that a contact structure ξ is called *overtwisted* if there exists an *overtwisted disk*: an embedded disk $\mathcal{D} \subset M$ such that for all $m \in \partial\mathcal{D}$, $T_m(\partial\mathcal{D}) \subset \xi_m$ but $T_m\mathcal{D} \not\subset \xi_m$. By Eliashberg's classification result [Eli89], contactomorphism classes of overtwisted contact structures on M are in one-to-one correspondence with homotopy classes of cooriented 2-plane distributions.

The following is the main result of this paper.

Theorem 1.1. *Suppose (M, ξ) is a closed oriented 3-manifold with a positive overtwisted contact structure. Then there exists a contact form λ and admissible complex multiplication J such that (M, λ, J) admits a stable finite energy foliation of Morse-Bott type. The foliation has precisely one nondegenerate asymptotic orbit and one or more Morse-Bott tori of asymptotic orbits, and every leaf is either an orbit cylinder or an index 2 finite energy sphere with distinct simply covered asymptotic orbits, all positive.*

We will spend the rest of §1.1 explaining the definitions needed to understand this statement.

Denote the time- t flow of X by φ_X^t , and recall that a closed orbit $x : \mathbb{R} \rightarrow M$ of X with period $T > 0$ is called *nondegenerate* if the linearized return map $d\varphi_X^T(x(0))|_{\xi_{x(0)}}$ does not have 1 in its spectrum. More generally, a *Morse-Bott manifold of T -periodic orbits* is a submanifold $N \subset M$ tangent to X such that $\varphi_X^T|_N$ is the identity, and for every $m \in N$,

$$T_m N = \ker(d\varphi_X^T(m) - \mathbf{1}).$$

In this paper we shall deal exclusively with situations where N is a circle (i.e. a nondegenerate orbit) or a two-dimensional torus. For the latter case, one can show (see [Wen]) that all orbits in N have the same minimal period $\tau > 0$, and N is a Morse-Bott family of $k\tau$ -periodic orbits for all $k \in \mathbb{N}$.

Thus we will call such submanifolds *Morse-Bott tori* without reference to the period, and a single closed orbit will be called simply *Morse-Bott* if it either is nondegenerate or belongs to a Morse-Bott torus.

The *symplectization* of M is the open 4-manifold $\mathbb{R} \times M$ with symplectic structure $d(e^a \lambda)$, where a denotes the coordinate on the \mathbb{R} -component. We consider a natural class of \mathbb{R} -invariant almost complex structures compatible with this symplectic form, defined as follows. Note the choice of contact form λ defines a splitting

$$T(\mathbb{R} \times M) = (\mathbb{R} \oplus \mathbb{R}X) \oplus \xi,$$

where the first factor also comes with a natural trivialization. An *admissible complex multiplication* is a choice of complex structure J for the bundle $\xi \rightarrow M$, compatible with the symplectic structure, i.e. we require that $d\lambda(\cdot, J\cdot)$ define a bundle metric. Given any such choice, we define an almost complex structure \tilde{J} on $\mathbb{R} \times M$ in terms of the above splitting and trivialization by

$$\tilde{J} = i \oplus J,$$

where i is understood as the natural complex structure acting on $\mathbb{C} = \mathbb{R}^2$. We will call \tilde{J} the *almost complex structure associated to λ and J* .

Given such a structure, we consider \tilde{J} -holomorphic curves

$$\tilde{u} = (a, u) : (\dot{\Sigma}, j) \rightarrow (\mathbb{R} \times M, \tilde{J}),$$

where the domain $\dot{\Sigma} = \Sigma \setminus \Gamma$ is a Riemann surface (Σ, j) with a discrete set of points $\Gamma \subset \Sigma$ removed. The *energy* of such a curve is defined as

$$(1.1) \quad E(\tilde{u}) = \sup_{\varphi \in \mathcal{T}} \int_{\dot{\Sigma}} \tilde{u}^* d(\varphi \lambda),$$

where $\mathcal{T} := \{\varphi \in C^\infty(\mathbb{R}, [0, 1]) \mid \varphi' \geq 0\}$. An easy computation shows that the integrand is nonnegative whenever \tilde{u} is \tilde{J} -holomorphic, and such a curve is constant if and only if $E(\tilde{u}) = 0$. When Σ is closed, \tilde{J} -holomorphic curves $\tilde{u} : \dot{\Sigma} \rightarrow \mathbb{R} \times M$ with $E(\tilde{u}) < \infty$ are called *finite energy surfaces*. By results in [Hof93, HWZ96a, HWZ96b], these have nicely controlled asymptotic behavior near the punctures, which can be described as follows. Denote by $\mathbb{D} \subset \mathbb{C}$ the closed unit disk with its natural complex structure, and let $\mathbb{D}_r \subset \mathbb{C}$ be the closed disk of radius r for any $r > 0$.

Proposition 1.2. *Suppose $\tilde{u} = (a, u) : \dot{\mathbb{D}} = \mathbb{D} \setminus \{0\} \rightarrow \mathbb{R} \times M$ is a \tilde{J} -holomorphic map with $0 < E(\tilde{u}) < \infty$. If \tilde{u} is bounded, then \tilde{u} extends to a \tilde{J} -holomorphic map $\mathbb{D} \rightarrow \mathbb{R} \times M$. Otherwise, \tilde{u} is a proper map, and for every sequence $s_k \rightarrow \infty$ there is a subsequence such that the loops $t \mapsto u(e^{-2\pi(s_k + it)})$ converge in $C^\infty(S^1, M)$ to a loop $t \mapsto x(Qt)$. Here $x : \mathbb{R} \rightarrow M$ is a periodic orbit of X with period $T = |Q|$, where*

$$(1.2) \quad Q = - \lim_{\epsilon \rightarrow 0} \int_{\partial \mathbb{D}_\epsilon} u^* \lambda \neq 0.$$

Moreover, $t \mapsto a(e^{-2\pi(s_k+it)})/s_k$ converges in $C^\infty(S^1, \mathbb{R})$ to the constant map $t \mapsto Q$.

If the orbit x is Morse-Bott, then in fact the maps $t \mapsto u(e^{-2\pi(s+it)})$ and $t \mapsto a(e^{-2\pi(s+it)})/s$ converge in $C^\infty(S^1)$ as $s \rightarrow \infty$.

The number $Q \in \mathbb{R} \setminus \{0\}$ appearing above is called the *charge* of the puncture, and we call the puncture positive/negative in accordance with the sign of Q . This defines a partition of the set of punctures:

$$\Gamma = \Gamma^+ \cup \Gamma^-,$$

and one can use the maximum principle to show that finite energy surfaces always have $\#\Gamma^+ \geq 1$, cf. [HWZ95a].

The simplest example of a finite energy surface is the so-called *orbit cylinder* or *trivial cylinder* over a T -periodic orbit $x : \mathbb{R} \rightarrow M$. Indeed, it's easy to check that the map

$$\tilde{u} : \mathbb{R} \times S^1 \rightarrow \mathbb{R} \times M : (s, t) \mapsto (Ts, x(Tt))$$

is \tilde{J} -holomorphic and has finite energy; after reparametrization, it is a sphere with one positive puncture and one negative. Prop. 1.2 above is a precise way of saying that any finite energy surface looks approximately like an orbit cylinder near each puncture.

Definition 1.3. A *finite energy foliation* for (M, λ, J) is a smooth two-dimensional foliation \mathcal{F} of $\mathbb{R} \times M$ such that

- (1) Each leaf $F \in \mathcal{F}$ can be presented as the image of an embedded \tilde{J} -holomorphic finite energy surface, and there exists a constant that bounds the energy of every leaf uniformly.
- (2) For every leaf $F \in \mathcal{F}$, the set $\sigma + F := \{(\sigma + a, m) \mid (a, m) \in F\}$ for $\sigma \in \mathbb{R}$ is also a leaf of the foliation, and thus either disjoint from or identical to F .

We shall often abuse notation and write $\tilde{u} \in \mathcal{F}$, meaning that the finite energy surface \tilde{u} parametrizes a leaf of \mathcal{F} . The \mathbb{R} -invariance assumption says that $\tilde{u} = (a, u) \in \mathcal{F}$ if and only if $\tilde{u}^\sigma := (a + \sigma, u) \in \mathcal{F}$ for all $\sigma \in \mathbb{R}$. This has several consequences for the projection of \mathcal{F} to the underlying contact manifold.

Proposition 1.4. *Let \mathcal{F} be a finite energy foliation. Then*

- (i) *If $P \subset M$ is a periodic orbit which is an asymptotic limit for some leaf $\tilde{u} \in \mathcal{F}$, then the orbit cylinder $\mathbb{R} \times P$ is also a leaf of \mathcal{F} .*
- (ii) *For each leaf $\tilde{u} = (a, u) : \dot{\Sigma} \rightarrow \mathbb{R} \times M$ of \mathcal{F} that is not an orbit cylinder, the map $u : \dot{\Sigma} \rightarrow M$ is embedded and does not intersect its asymptotic limits.*
- (iii) *If $\tilde{u} = (a, u) : \dot{\Sigma} \rightarrow \mathbb{R} \times M$ and $\tilde{v} = (b, v) : \dot{\Sigma}' \rightarrow \mathbb{R} \times M$ are two leaves of \mathcal{F} , then $u(\dot{\Sigma})$ and $v(\dot{\Sigma}')$ are either disjoint or identical.*

The proofs of these properties are mostly straightforward exercises using positivity of intersections; we refer to [Wen05] for details. The only detail

not covered there is the fact that the maps $u : \dot{\Sigma} \rightarrow M$ are not just injective but also *embedded*: for this one uses intersection theory to show that a critical point of u at $z \in \dot{\Sigma}$ implies intersections between (a, u) and $(a + \epsilon, u)$ near z for small ϵ ; cf. [Wen]. Denote by $\mathcal{P}_{\mathcal{F}} \subset M$ the union of all the closed orbits that occur as asymptotic limits for leaves of \mathcal{F} ; equivalently, this is the projection down to M of all the orbit cylinders in \mathcal{F} . Then Prop. 1.4 can be rephrased as follows.

Corollary 1.5. *If \mathcal{F} is a finite energy foliation, then the projections of its leaves from $\mathbb{R} \times M$ to M form a smooth foliation of $M \setminus \mathcal{P}_{\mathcal{F}}$.*

To explain the stability condition, we need to introduce some more technical details. In the following, write periodic orbits of X in the notation $P := (x(\mathbb{R}), T)$ where $x : \mathbb{R} \rightarrow M$ is a T -periodic solution of the Reeb flow equation; note that T need not be the *minimal* period, and the parametrization x can always be changed by a time shift. We shall sometimes abuse notation and regard P as a subset of M , keeping in mind that T is also part of the data. Recall that if P is nondegenerate, we can choose a unitary trivialization Φ of ξ along P and define the *Conley-Zehnder index* $\mu_{\text{CZ}}^{\Phi}(P)$ as in [HWZ95a]. Then a finite energy surface $\tilde{u} : \dot{\Sigma} \rightarrow \mathbb{R} \times M$ with only nondegenerate asymptotic orbits $\{P_z\}_{z \in \Gamma}$ is assigned the Conley-Zehnder index

$$\mu_{\text{CZ}}(\tilde{u}) = \sum_{z \in \Gamma^+} \mu_{\text{CZ}}^{\Phi}(P_z) - \sum_{z \in \Gamma^-} \mu_{\text{CZ}}^{\Phi}(P_z),$$

where the trivializations Φ are chosen so as to admit an extension to a global complex trivialization of ξ along \tilde{u} ; then $\mu_{\text{CZ}}(\tilde{u})$ doesn't depend on this choice.

This index can be extended to the Morse-Bott case in the following straightforward manner. Given P , define an *admissible parametrization* of P to be any map $\mathbf{x} : S^1 \rightarrow P \subset M$ such that $\lambda(\dot{\mathbf{x}}) \equiv T$. This defines the so-called *asymptotic operator*

$$(1.3) \quad \mathbf{A}_{\mathbf{x}} : \Gamma(\mathbf{x}^*\xi) \rightarrow \Gamma(\mathbf{x}^*\xi) : v \mapsto -J(\nabla_t v - T\nabla_v X),$$

where ∇ is any symmetric connection on M ; one can check that this expression gives a well defined section of $\mathbf{x}^*\xi$, not depending on ∇ . As an unbounded operator on $L^2(\mathbf{x}^*\xi)$ with domain $H^1(\mathbf{x}^*\xi)$, $\mathbf{A}_{\mathbf{x}}$ is self-adjoint, with spectrum consisting of discrete real eigenvalues of finite multiplicity, accumulating only at infinity. The equation $\mathbf{A}_{\mathbf{x}}v = 0$ then defines the linearized Reeb flow restricted to ξ along P , and P is nondegenerate if and only if $\ker \mathbf{A}_{\mathbf{x}} = \{0\}$. When this is the case, one can define the linearized Reeb flow purely in terms of the equation $\mathbf{A}_{\mathbf{x}}v = 0$ and sensibly denote the Conley-Zehnder index by $\mu_{\text{CZ}}^{\Phi}(P) = \mu_{\text{CZ}}^{\Phi}(\mathbf{A}_{\mathbf{x}})$. The key observation now is that for any $c \in \mathbb{R}$, the equation $(\mathbf{A}_{\mathbf{x}} - c)v = 0$ also defines a linear Hamiltonian flow, and thus yields a well defined Conley-Zehnder index if c is not an eigenvalue of $\mathbf{A}_{\mathbf{x}}$. Then if P belongs to a Morse-Bott manifold

$N \subset M$, we can pick any sufficiently small number $\epsilon > 0$ and define the *perturbed* Conley-Zehnder indices

$$(1.4) \quad \mu_{\text{CZ}}^{\Phi_{\pm}}(P) = \mu_{\text{CZ}}^{\Phi}(\mathbf{A}_{\mathbf{x}} \pm \epsilon).$$

This doesn't depend on ϵ if the latter is sufficiently small, but does depend on the sign choice whenever $\ker \mathbf{A}_{\mathbf{x}}$ is nontrivial, i.e. when P is degenerate. For \tilde{u} with Morse-Bott asymptotic orbits, we now define its Conley-Zehnder index by

$$\mu_{\text{CZ}}(\tilde{u}) = \sum_{z \in \Gamma^+} \mu_{\text{CZ}}^{\Phi^-}(P_z) - \sum_{z \in \Gamma^-} \mu_{\text{CZ}}^{\Phi^+}(P_z)$$

which is equal to the previous definition if all P_z are nondegenerate.

The *moduli space of finite energy surfaces* $\mathcal{M}_{\tilde{j}}$ is the set of equivalence classes $C = [(\Sigma, j, \Gamma, \tilde{u})]$, where $\tilde{u} : (\Sigma \setminus \Gamma, j) \rightarrow (\mathbb{R} \times M, \tilde{J})$ is a finite energy surface, Γ is assigned an *ordering*, and $(\Sigma, j, \Gamma, \tilde{u}) \sim (\Sigma', j', \Gamma', \tilde{u}')$ if and only if there is a biholomorphic map $\varphi : (\Sigma, j) \rightarrow (\Sigma', j')$ that takes Γ to Γ' with ordering preserved and satisfies $\tilde{u} = \tilde{u}' \circ \varphi$. We shall sometimes abuse notation and write $\tilde{u} \in \mathcal{M}_{\tilde{j}}$ when there is no confusion.

To define a topology on $\mathcal{M}_{\tilde{j}}$, first note that the punctured Riemann surface $(\dot{\Sigma}, j)$ can be regarded as a surface with cylindrical ends, which then admits a natural compactification. Indeed, for each $z \in \Gamma^{\pm}$, pick a closed disk-like neighborhood \mathcal{D}_z of z in Σ and a biholomorphic map $\dot{\mathcal{D}}_z := \mathcal{D} \setminus \{z\} \rightarrow Z_{\pm}$, where

$$(1.5) \quad Z_+ = [0, \infty) \times S^1, \quad Z_- = (-\infty, 0] \times S^1,$$

both with the standard complex structure i . This decomposes $\dot{\Sigma}$ in the form

$$\dot{\Sigma} \cong \Sigma_0 \cup \left(\bigcup_{z \in \Gamma^{\pm}} Z_{\pm} \right),$$

where Σ_0 is a compact surface with boundary. We now define the compactified surface $\overline{\Sigma}$ by adding ‘‘circles at infinity,’’ which means replacing each Z_{\pm} with \overline{Z}_{\pm} , where

$$\overline{Z}_+ = [0, \infty] \times S^1, \quad \overline{Z}_- = [-\infty, 0] \times S^1.$$

Denote the components of $\partial \overline{\Sigma}$ by $\delta_z \cong \{\pm\infty\} \times S^1$ for each $z \in \Gamma^{\pm}$. We shall not place a smooth structure on $\overline{\Sigma}$. It is naturally a compact *topological* manifold with boundary, where the interior $\dot{\Sigma} \subset \overline{\Sigma}$ and the boundary components δ_z all have natural smooth structures; in fact the latter have natural identifications with S^1 up to translation, and one can show that none of this structure depends on the choices.

The symplectization $W := \mathbb{R} \times M$ also has a natural compactification $\overline{W} := [-\infty, \infty] \times M$, which we again regard as a topological manifold with boundary, on which the interior and the boundary separately have natural smooth structures. It is then convenient to observe that any finite energy surface $\tilde{u} : \dot{\Sigma} \rightarrow W$ extends naturally to a continuous map $\bar{u} : \overline{\Sigma} \rightarrow \overline{W}$,

whose restriction to each δ_z gives an admissible parametrization of the corresponding orbit $P_z \subset \{\pm\infty\} \times M$.

We say that a sequence $C_k \in \mathcal{M}_{\bar{j}}$ converges to $C \in \mathcal{M}_{\bar{j}}$ if for sufficiently large k there exist representatives $(\Sigma, j_k, \Gamma, \tilde{u}_k) \in C_k$ and $(\Sigma, j, \Gamma, \tilde{u}) \in C$ such that

- (1) $j_k \rightarrow j$ in $C^\infty(\Sigma)$
- (2) $\tilde{u}_k \rightarrow \tilde{u}$ in $C_{\text{loc}}^\infty(\dot{\Sigma}, W)$,
- (3) $\bar{u}_k \rightarrow \bar{u}$ in $C^0(\bar{\Sigma}, \bar{W})$.

This defines the topology on the moduli space $\mathcal{M}_{\bar{j}}$.

For any finite energy surface $\tilde{u} : \dot{\Sigma} \rightarrow \mathbb{R} \times M$ with Morse-Bott asymptotic orbits, define the *index* of \tilde{u} by

$$(1.6) \quad \text{ind}(\tilde{u}) = \mu_{\text{CZ}}(\tilde{u}) - \chi(\dot{\Sigma}).$$

This is the Fredholm index of the *linearized normal Cauchy-Riemann operator* $\mathbf{L}_{\tilde{u}}$, which is explained in [HWZ99] for the nondegenerate case and [Wen] in general. We call \tilde{u} *regular* if the operator $\mathbf{L}_{\tilde{u}}$ is surjective; in this case the implicit function theorem allows us to describe a neighborhood of \tilde{u} in $\mathcal{M}_{\bar{j}}$ as a smooth manifold of dimension $\text{ind}(\tilde{u})$. In the general Morse-Bott case there is a stronger notion of regularity: suppose \tilde{u} has a puncture $z \in \Gamma$ at which the asymptotic orbit belongs to a Morse-Bott torus $N \subset M$, and let $\mathcal{U}_{\tilde{u}} \subset \mathcal{M}_{\bar{j}}$ denote a connected open neighborhood of \tilde{u} . We can assume without loss of generality that all curves in $\mathcal{U}_{\tilde{u}}$ are parametrized on the same domain Σ with the puncture $z \in \Gamma \subset \Sigma$ in a fixed position. The Reeb flow along N defines an S^1 -action so that N/S^1 is a circle, and there is then a natural evaluation map

$$\text{ev}_z : \mathcal{U}_{\tilde{u}} \rightarrow N/S^1,$$

defined by assigning to any curve in $\mathcal{U}_{\tilde{u}}$ its asymptotic orbit $P_z \subset N$. We say that \tilde{u} is *strongly regular* if it is regular and for every $z \in \Gamma$ where P_z is degenerate, ev_z has a surjective linearization at \tilde{u} .

Definition 1.6. A finite energy foliation \mathcal{F} is called *stable* if $\mathcal{P}_{\mathcal{F}}$ is a finite union of nondegenerate Reeb orbits, and every leaf $F \in \mathcal{F}$ is parametrized by a *regular* finite energy surface $\tilde{u}_0 \in \mathcal{M}_{\bar{j}}$ such that all other curves $\tilde{u} \in \mathcal{M}_{\bar{j}}$ near \tilde{u}_0 also parametrize leaves of \mathcal{F} .

We say that \mathcal{F} is a *stable foliation of Morse-Bott type* if $\mathcal{P}_{\mathcal{F}}$ is a finite union of nondegenerate Reeb orbits and Morse-Bott tori, and each leaf is a *strongly regular* finite energy surface whose neighbors in $\mathcal{M}_{\bar{j}}$ are also leaves of \mathcal{F} .

Observe that leaves of stable finite energy foliations can only have index 0, 1 or 2. The index 0 leaves are precisely the orbit cylinders, while index 1 leaves are called *rigid surfaces*, because they project to isolated leaves in the foliation of $M \setminus \mathcal{P}_{\mathcal{F}}$. Index 2 leaves come in \mathbb{R} -invariant 2-parameter families, which project to 1-parameter families in $M \setminus \mathcal{P}_{\mathcal{F}}$. In

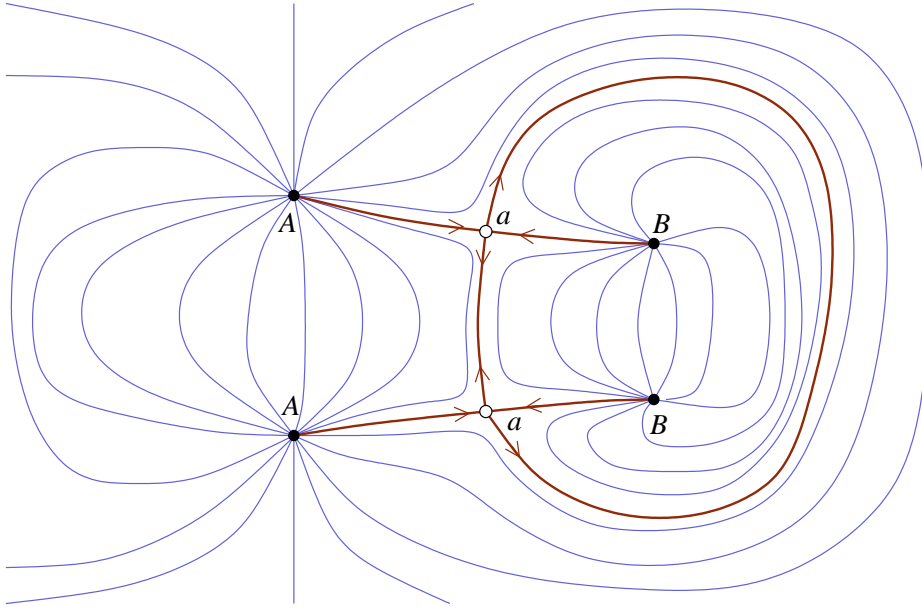

FIGURE 1. A cross section of a stable finite energy foliation on $S^3 = \mathbb{R}^3 \cup \{\infty\}$, with three asymptotic orbits cutting transversely through the page. The hyperbolic orbit a is the limit of two rigid planes, and is connected to two elliptic orbits A and B by rigid cylinders. All other leaves are index 2 planes asymptotic to A or B . Arrows represent the signs of the punctures at a : a puncture is positive/negative if the arrow points away from/toward the orbit.

the Morse-Bott case, orbit cylinders can also have index 1, projecting to M as 1-parameter families moving along Morse-Bott tori.

1.2. Outline of the proof. The surgery construction involves two main technical ingredients. The first is the Fredholm and intersection theory for the mixed boundary value problem considered in [Wen], which we review in §2. The crucial point is to observe that embedded index 2 curves with certain properties are always regular, and give rise to non-intersecting 2-parameter families of embedded curves, which project to 1-parameter families of embeddings in M .

The second main ingredient is a compactness argument: this is explained in §3 and constitutes the bulk of the technical work in this paper. While we borrow certain ideas from the compactness theorems of Symplectic Field Theory [BEH⁺03], those results cannot be applied and are in fact not true in our setup, because we make only very weak nondegeneracy assumptions on our data. This is necessary in order to accommodate nontrivial homotopies of the data, but it allows potentially quite strange asymptotic behavior for holomorphic curves. Thus in our situation, the moduli space

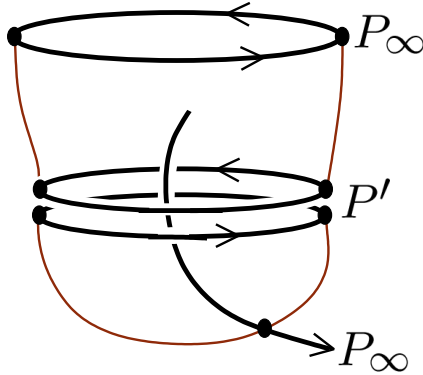

FIGURE 2. A finite energy plane bubbles off and produces an illegal intersection with the asymptotic limit P_∞ . This gives a topological obstruction to noncompactness.

generally has no natural compactification—yet we’ll find that the particular spaces of interest encounter topological obstructions to noncompactness, which are peculiar to the low-dimensional setting. In this way, our arguments are quite different from those in [BEH⁺03]. This is illustrated by the example in Figure 2. Here we consider the degeneration of a sequence of finite energy planes \tilde{u}_k in $\mathbb{R} \times S^3$, all asymptotic to the same simply covered orbit $P_\infty \subset S^3$ and not intersecting it. Without assuming that the Reeb vector field is nondegenerate, it is sometimes possible to show that any other closed orbit $P \subset S^3$ must be nontrivially linked with P_∞ . Then if a plane bubbles off as in the picture, its asymptotic limit P' must be linked with P_∞ , implying that the new plane intersects P_∞ . But then P_∞ must also intersect \tilde{u}_k for sufficiently large k , giving a contradiction. Some more elaborate variations on this argument will be used repeatedly in §3.

The main result is then proved in §4: starting with a stable finite energy foliation on the tight three-sphere (an open book decomposition with one nondegenerate binding orbit), we perform a combination of rational Dehn surgery and Lutz twists along a transverse link $K \subset S^3$ and show that the resulting contact manifold also admits a stable foliation, now of Morse-Bott type. The topological preliminaries on surgery and Lutz twists are explained in §4.1. In §4.2, we tackle the easiest step in the foliation construction, finding families of holomorphic curves to fill the solid tori that are glued in by surgery. This is done by explicitly solving the nonlinear Cauchy-Riemann equation on $S^1 \times B^2 \subset S^1 \times \mathbb{R}^2$, with rotationally symmetric contact forms and complex structures.

The technical background of §2 and §3 is then applied in §4.3 to change a given open book decomposition of S^3 (which can also be constructed explicitly) into a stable Morse-Bott foliation in the complement of a transverse link neighborhood. The key is to remove a collection of disks from each page of the open book, obtaining holomorphic curves with boundary, which satisfy a problem of the type considered in §2, with images avoiding

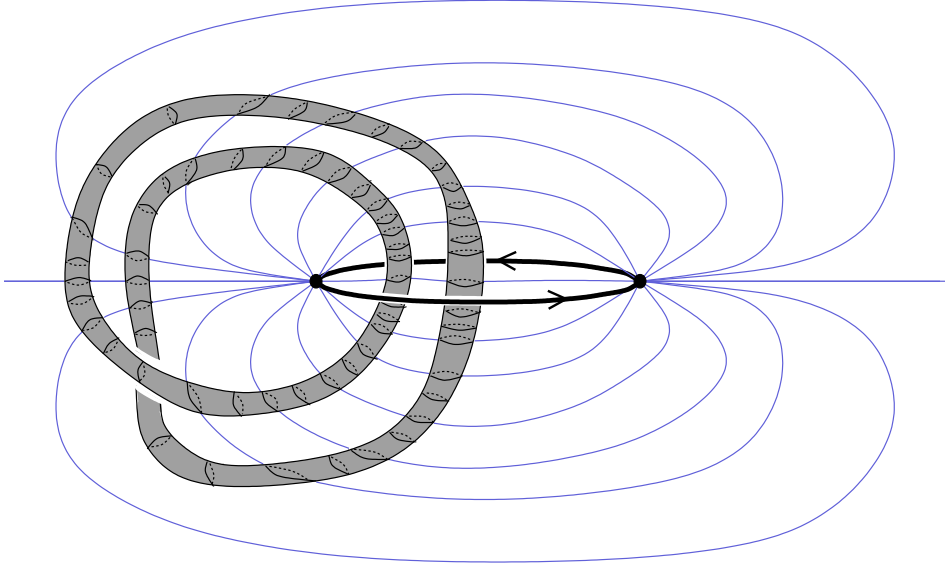

FIGURE 3. The stable Morse-Bott finite energy foliation obtained from an open book decomposition of S^3 after surgery along a transverse knot K , linked twice with the binding orbit. Each leaf in the region outside the surgery has three punctures: one at the original binding orbit, and two at Morse-Bott orbits along the torus around K .

the region inside a set of small tori. Thus we are now free to perform surgery and Lutz twists inside these tori without killing the holomorphic curves outside; the region inside can afterwards be filled in by the explicitly constructed curves from §4.2.

In principle, the curves with boundary filling the region outside the tori can be homotoped as the contact form is twisted, so that in the limit, all boundary components degenerate to punctures, giving rise to finite energy surfaces without boundary. The actual argument is not quite so simple, because the curves obtained by cutting out disks generally satisfy a boundary condition that is *totally real* but not *Lagrangian*, thus lacking *a priori* energy bounds. This problem does not appear to be solvable for all curves at once, but we can deal with a single curve in the case where each component of K is only singly linked with the binding orbit: this makes it possible to construct the totally real surface in $\mathbb{R} \times M$ so that it is equivalent via a diffeomorphism to a Lagrangian surface in the symplectization of M with a *stable Hamiltonian structure*, i.e. the generalization of a contact form described in [BEH⁺03]. We can then homotop this back to contact data but keep the Lagrangian boundary condition, and use the implicit function theorem to extend the single curve again to a whole foliation. The only catch is that this trick requires the restrictive assumption that components of K link only once with the binding orbit. We fix this in §4.4

by viewing the general case as a branched cover: the foliation can then be lifted to the cover using intersection theory.

1.3. Discussion. The result proved here is one step in a program proposed by Hofer to study Reeb dynamics on arbitrary closed contact 3-manifolds via finite energy foliations; this is joint work in progress by the author with Hofer, R. Siefring and J. Fish. As was shown in [HWZ03], the existence of finite energy foliations on (S^3, ξ_0) implies that generic Reeb vector fields in that setting admit either two or infinitely many periodic orbits. The present work does not imply such a result for overtwisted contact manifolds, because we fix a very specific contact form. The next step would therefore be a homotopy argument in which one shows that a foliation of (M, λ, J) gives rise to a foliation (or something similar) of $(M, f\lambda, J')$ for generic positive smooth functions f and complex multiplications J' . One can then try to extend this to tight contact manifolds by the following trick: any (M, ξ) can be made overtwisted by taking a connected sum of (M, ξ) with (S^3, ξ_{ot}) for some ξ_{ot} overtwisted. One would then like to understand what happens to a sequence of foliations on the overtwisted object as one pinches off the overtwisted part. It is known that this program *cannot* in general lead to a stable finite energy foliation for generic (M, λ, J) , as there are examples of tight contact manifolds where stable foliations don't exist (cf. [Wen]). Nonetheless, the limits obtained in such spaces from sequences of foliations should be interesting objects, with possible dynamical implications.

A related program is of a more topological nature: the author proposed in [Wen05, Chapter 6] an equivalence relation for stable finite energy foliations, called *concordance*, which is defined by the existence of stable holomorphic foliations on cylindrical symplectic cobordisms. The goal would then be to classify all foliations for a given (M, ξ) up to concordance. Conjecturally, two concordance classes can be distinguished by an invariant $HC_*(\mathcal{F})$, which is a version of *contact homology* (or more generally, symplectic field theory [EGH00]) that counts the orbits and rigid surfaces in the foliation. In this framework, the constructions of the present paper show that every overtwisted (M, ξ) admits a foliation \mathcal{F} for which $HC_*(\mathcal{F})$ is trivial. As suggested however by an example in [Wen05], this is not true for *all* foliations on overtwisted contact manifolds.

We should mention the related work of C. Abbas [Abb], which uses the open book decompositions of Giroux [Gir02, Gir] to produce (in the planar case) open book decompositions with pseudoholomorphic pages. Due to Etnyre's result that all overtwisted contact structures are planar [Etn04], this also produces a finite energy foliation for all overtwisted contact manifolds. The two constructions are however quite different, e.g. ours is not an open book decomposition, and the foliations of Abbas appear to have nontrivial contact homology in the sense described above, suggesting that they are not equivalent to ours via concordance.

Acknowledgements. Much of the material covered here appeared originally—in more detailed and sometimes more complicated forms—in my Ph.D. thesis [Wen05], and I thank Helmut Hofer for many valuable suggestions and insights. I’m grateful also to Denis Auroux, Kai Cieliebak, Yasha Eliashberg, Brett Parker, Richard Siefring and Katrin Wehrheim for helpful conversations.

2. A MIXED BOUNDARY VALUE PROBLEM

In this section we review the basic facts about the boundary value problem considered in [Wen], referring to that paper for all proofs.

Let M be a closed, oriented 3-manifold. A *stable Hamiltonian structure* on M is a tuple $\mathcal{H} = (\xi, X, \omega, J)$ where

- ξ is a smooth cooriented 2-plane distribution on M
- ω is a smooth closed 2-form on M which restricts to a symplectic structure on the vector bundle $\xi \rightarrow M$
- X is a smooth vector field which is transverse to ξ , satisfies $\omega(X, \cdot) \equiv 0$, and whose flow preserves ξ
- J is a smooth complex structure on the bundle $\xi \rightarrow M$, compatible with ω in the sense that $\omega(\cdot, J\cdot)$ defines a bundle metric

It follows from these definitions that the flow of X also preserves the symplectic structure defined by ω on ξ , and the special 1-form λ associated to ξ and X by the conditions

$$\lambda(X) \equiv 1, \quad \ker \lambda \equiv \xi,$$

satisfies $d\lambda(X, \cdot) \equiv 0$.

Example 2.1. Given a contact form λ on M with contact structure $\xi = \ker \lambda$, Reeb vector field X and admissible complex multiplication J , the data $\mathcal{H} = (\xi, X, d\lambda, J)$ define a stable Hamiltonian structure.

The stable Hamiltonian structure of Example 2.1 is referred to as *the contact case*. We will define and use a non-contact example in §4.3.

An \mathbb{R} -invariant almost complex structure \tilde{J} on $\mathbb{R} \times M$ is associated to any $\mathcal{H} = (\xi, X, \omega, J)$ by defining $\tilde{J}\partial_a = X$ and $\tilde{J}v = Jv$ for $v \in \xi$, where again a denotes the coordinate on the \mathbb{R} -factor and ∂_a is the unit vector in the \mathbb{R} -direction. Since $d\lambda|_\xi$ may now be degenerate, we generalize the definition of energy for pseudoholomorphic curves $\tilde{u} = (a, u) : (\Sigma, j) \rightarrow (\mathbb{R} \times M, \tilde{J})$ by

$$E(\tilde{u}) = E_\omega(\tilde{u}) + E_\lambda(\tilde{u}),$$

where

$$E_\omega(\tilde{u}) = \int_\Sigma u^* \omega$$

is the so-called ω -energy, and

$$E_\lambda(\tilde{u}) = \sup_{\varphi \in \mathcal{T}} \int_\Sigma \tilde{u}^*(d\varphi \wedge \lambda),$$

with \mathcal{T} defined as in (1.1). In the contact case this definition is equivalent to (1.1), in the sense that uniform bounds on one imply uniform bounds on the other. Punctured \tilde{J} -holomorphic curves with finite energy in this generalized sense also have asymptotically cylindrical behavior near punctures, the same as in Prop. 1.2. The next result, which follows from arguments in [HWZ96a, HWZ96b, Sie05], gives a more precise and useful statement. Recall from (1.5) the definition of the positive and negative half-cylinders Z_{\pm} .

Proposition 2.2. *Let $\mathcal{H} = (\xi, X, \omega, J)$ be a stable Hamiltonian structure on M with associated almost complex structure \tilde{J} , and choose a metric on M . Suppose $\tilde{u} = (a, u) : Z_{\pm} \rightarrow \mathbb{R} \times M$ is a finite energy \tilde{J} -holomorphic map asymptotic (with sign corresponding to the choice of Z_+ or Z_-) to a Morse-Bott orbit $P \subset M$ with admissible parametrization $\mathbf{x} : S^1 \rightarrow M$. There is then a smooth map $h : Z_{\pm} \rightarrow \mathbf{x}^*\xi$ with $h(s, t) \in \xi_{\mathbf{x}(t)}$ such that, up to translation by constants in s and t , $u(s, t) = \exp_{\mathbf{x}(t)} h(s, t)$ for $|s|$ sufficiently large. Moreover, either $h(s, t) \equiv 0$ or it satisfies the formula*

$$(2.1) \quad h(s, t) = e^{\mu s}(\eta(t) + r(s, t))$$

where $\eta \in \Gamma(\mathbf{x}^*\xi)$ is an eigenfunction of the asymptotic operator $\mathbf{A}_{\mathbf{x}}$ in (1.3), $\mu \neq 0$ is the corresponding eigenvalue, whose sign is opposite that of the puncture, and $r(s, t) \rightarrow 0$ uniformly in t as $s \rightarrow \pm\infty$.

Definition 2.3. The section $e \in \Gamma(\mathbf{x}^*\xi)$ appearing in (2.1) is called the *asymptotic eigenfunction* of \tilde{u} at the puncture; it is well defined up to a positive multiple. Note that $e(t)$ is never zero, so given a trivialization Φ of $\mathbf{x}^*\xi$, there is a well defined winding number $\text{wind}^{\Phi}(e) \in \mathbb{Z}$.

For some integer $m \geq 0$, let $L_1, \dots, L_m \subset M$ be a collection of smoothly embedded surfaces which are everywhere tangent to X . Choosing smooth functions $g_j : L_j \rightarrow \mathbb{R}$, the graphs

$$(2.2) \quad \tilde{L}_j := \{(g_j(x), x) \in \mathbb{R} \times M \mid x \in L_j\}$$

are then totally real submanifolds of $(\mathbb{R} \times M, \tilde{J})$, and so are their \mathbb{R} -translations

$$\tilde{L}_j^{\sigma} := \{(g_j(x) + \sigma, x) \in \mathbb{R} \times M \mid x \in L_j\}$$

for every $\sigma \in \mathbb{R}$. Denote $\Lambda = (\tilde{L}_1, \dots, \tilde{L}_m)$. Then we define the moduli space

$$\mathcal{M}_{\mathcal{H}, \Lambda}$$

to consist of equivalence classes $[(\Sigma, j, \Gamma, \tilde{u})]$ where (Σ, j) is a compact Riemann surface with an ordered set of m boundary components

$$\partial\Sigma = \gamma_1 \cup \dots \cup \gamma_m,$$

$\Gamma \subset \text{int } \Sigma$ is a finite ordered set of *interior* points giving rise to the punctured Riemann surface $\dot{\Sigma} = \Sigma \setminus \Gamma$ with boundary $\partial\dot{\Sigma} = \partial\Sigma$, and

$\tilde{u} : (\dot{\Sigma}, j) \rightarrow (\mathbb{R} \times M, \tilde{J})$ is a pseudoholomorphic map with $E(\tilde{u}) < \infty$ and satisfying the following boundary condition:

For each component $\gamma_j \subset \partial\Sigma$, there exists a number $\sigma_j \in \mathbb{R}$ such that $\tilde{u}(\gamma_j) \subset \tilde{L}_j^{\sigma_j}$.

As before, we will abuse notation and write $\tilde{u} \in \mathcal{M}_{\mathcal{H},\Lambda}$ whenever convenient. Equivalence in $\mathcal{M}_{\mathcal{H},\Lambda}$ is defined by biholomorphic maps that preserve the ordering of both the punctures and the boundary components, and the definition of convergence used in §1.1 to topologize $\mathcal{M}_{\tilde{J}}$ also naturally gives a topology on $\mathcal{M}_{\mathcal{H},\Lambda}$. Note that in the case where \mathcal{H} is contact and $m = 0$ (i.e. $\partial\Sigma = \emptyset$), $\mathcal{M}_{\mathcal{H},\Lambda}$ is simply $\mathcal{M}_{\tilde{J}}$, the space of \tilde{J} -holomorphic finite energy surfaces. Observe also that $\mathcal{M}_{\mathcal{H},\Lambda}$ admits a natural \mathbb{R} -action

$$\mathbb{R} \times \mathcal{M}_{\mathcal{H},\Lambda} \rightarrow \mathcal{M}_{\mathcal{H},\Lambda} : (\sigma, (a, u)) \mapsto \tilde{u}^\sigma := (a + \sigma, u).$$

The Conley-Zehnder index generalizes to $\tilde{u} = (a, u) \in \mathcal{M}_{\mathcal{H},\Lambda}$ as follows. For each puncture $z \in \Gamma$, let P_z be the corresponding orbit of X approached by \tilde{u} . The bundle ξ along P_z has a symplectic structure ω , which is preserved by the linearized flow of X , thus we can choose a unitary trivialization Φ and define $\mu_{CZ}^{\Phi\pm}(P_z)$ as in (1.4). Now at each component $\gamma_j \subset \partial\Sigma$, $u^*\xi$ has a totally real subbundle $\ell \rightarrow \gamma_j$ defined for $z \in \gamma_j$ by

$$\ell_z = \xi_{u(z)} \cap T_{u(z)}L_j;$$

here we exploit the fact that X is tangent to L_j , hence ξ and L_j are transverse. Then if $m + \#\Gamma > 0$, we can choose trivializations Φ at each orbit and each boundary component so that these extend to a global complex trivialization of $u^*\xi \rightarrow \dot{\Sigma}$, and define the *Maslov index* of \tilde{u} as

$$\mu(\tilde{u}) = \sum_{z \in \Gamma^+} \mu_{CZ}^{\Phi-}(P_z) - \sum_{z \in \Gamma^-} \mu_{CZ}^{\Phi+}(P_z) + \sum_{j=1}^m \mu^\Phi(u^*\xi|_{\gamma_j}, \ell),$$

where the last term is a sum of Maslov indices for the loops of totally real subspaces ℓ along γ_j with respect to the complex trivialization Φ . If $m = \#\Gamma = 0$, so $\dot{\Sigma}$ is closed, we instead define

$$\mu(\tilde{u}) = 2c_1(u^*\xi).$$

The *Fredholm index* of \tilde{u} is then the integer

$$(2.3) \quad \text{ind}(\tilde{u}) = \mu(\tilde{u}) - \chi(\dot{\Sigma}) + m.$$

As with finite energy surfaces, a neighborhood of $\tilde{u} \in \mathcal{M}_{\mathcal{H},\Lambda}$ can be described via a linearized normal Cauchy-Riemann operator $\mathbf{L}_{\tilde{u}}$, and the previous definitions of *regular* and *strongly regular* carry over immediately.

We now collect some useful results about the moduli space $\mathcal{M}_{\mathcal{H},\Lambda}$. The first important observation is that $\tilde{u} = (a, u) \in \mathcal{M}_{\mathcal{H},\Lambda}$ is never equivalent to its \mathbb{R} -translations $\tilde{u}^\sigma = (a + \sigma, u)$ for small σ unless it is tangent everywhere to $\mathbb{R} \oplus \mathbb{R}X \subset T(\mathbb{R} \times M)$, which implies $E_\omega(\tilde{u}) = 0$. Thus when $E_\omega(\tilde{u}) > 0$, \tilde{u}

and \tilde{u}^σ have only isolated, positive intersections. The infinitesimal version of this statement deals with the zeros of the section

$$\pi Tu : \dot{\Sigma} \rightarrow \text{Hom}_{\mathbb{C}}(T\dot{\Sigma}, u^*\xi),$$

which composes the tangent map Tu with the projection $\pi : TM \rightarrow \xi$ along X . Counting these zeros algebraically defines the nonnegative homotopy invariant $\text{wind}_\pi(\tilde{u})$, which is a half-integer in general because zeros at the boundary must be counted with half weight. The map $u : \dot{\Sigma} \rightarrow M$ is immersed if and only if $\text{wind}_\pi(\tilde{u}) = 0$, and in this case the Cauchy-Riemann equation implies it is also transverse to X . Due to Prop. 2.2 and the relations proved in [HWZ95a] between the spectrum of the asymptotic operator at an orbit and the orbit's Conley-Zehnder index, $\text{wind}_\pi(\tilde{u})$ is also bounded from above:

Theorem 2.4. *For any $\tilde{u} \in \mathcal{M}_{\mathcal{H},\Lambda}$ with $E_\omega(\tilde{u}) > 0$,*

$$0 \leq 2 \text{wind}_\pi(\tilde{u}) \leq \text{ind}(\tilde{u}) - 2 + 2g + \#\Gamma_0,$$

where g denotes the genus of Σ and Γ_0 is the set of $z \in \Gamma^\pm$ for which $\mu_{CZ}^{\Phi^\mp}(P_z)$ is even (for any trivialization Φ).

Nondegenerate *elliptic* orbits always have odd Conley-Zehnder index, thus punctures at such orbits never belong to Γ_0 . The next lemma gives a useful criterion in the degenerate Morse-Bott case. It follows, for instance, that $z \notin \Gamma_0$ if P_z belongs to a Morse-Bott torus which never intersects the image of u .

Lemma 2.5. *Suppose $\tilde{u} = (a, u) \in \mathcal{M}_{\mathcal{H},\Lambda}$ is asymptotic at $z \in \Gamma^\pm$ to an orbit P_z belonging to a Morse-Bott torus $N_z \subset M$. Let Φ_0 be the natural trivialization of ξ along P_z determined by the directions tangent to N_z , and suppose that the asymptotic eigenfunction e of \tilde{u} at z satisfies $\text{wind}^{\Phi_0}(e) = 0$. Then $\mu_{CZ}^{\Phi_0^\mp}(P_z) = \pm 1$.*

Analogously to πTu , sections in $\ker \mathbf{L}_{\tilde{u}}$ have only positive zeros and the count of these satisfies a similar upper bound. When this bound is zero in particular, we find $\dim \ker \mathbf{L}_{\tilde{u}} \leq 2$, leading to the conclusion in the embedded index 2 case that \tilde{u} is regular without need for any genericity assumption. Moreover, nearby curves in the moduli space can be identified with sections in $\ker \mathbf{L}_{\tilde{u}}$ which have no zeros, and therefore the nearby curves have no intersections except possibly near infinity. The latter can be excluded *a priori* in the situation of interest to us here, and we obtain the following special case of a result in [Wen]:

Theorem 2.6. *Suppose $\tilde{u} = (a, u) : \dot{\Sigma} \rightarrow \mathbb{R} \times M$ represents an element of $\mathcal{M}_{\mathcal{H},\Lambda}$ and has the following properties:*

- (1) \tilde{u} is embedded.
- (2) u is injective or $\partial\Sigma = \emptyset$.
- (3) All asymptotic orbits P_z for $z \in \Gamma$ are Morse-Bott, simply covered and geometrically distinct from one another.

- (4) $\text{ind}(\tilde{u}) = 2$.
- (5) Σ has genus 0.
- (6) For each $z \in \Gamma^\pm$, $\mu_{CZ}^{\Phi^\mp}(P_z)$ is odd (for any trivialization Φ).

Then \tilde{u} is strongly regular and a neighborhood of \tilde{u} in $\mathcal{M}_{\mathcal{H},\Lambda}$ has naturally the structure of a smooth 2-dimensional manifold. In fact, there exists an embedding

$$\begin{aligned} \mathbb{R} \times (-1, 1) \times \dot{\Sigma} &\xrightarrow{\tilde{F}} \mathbb{R} \times M \\ (\sigma, \tau, z) &\longmapsto (a_\tau(z) + \sigma, u_\tau(z)) \end{aligned}$$

such that

- (i) For $\sigma \in \mathbb{R}$ and $\tau \in (-1, 1)$, the embeddings $\tilde{u}_{(\sigma,\tau)} = \tilde{F}(\sigma, \tau, \cdot) : \dot{\Sigma} \rightarrow \mathbb{R} \times M$ parametrize elements of $\mathcal{M}_{\mathcal{H},\Lambda}$, and $\tilde{u}_{(0,0)} = \tilde{u}$.
- (ii) The map $F(\tau, z) = u_\tau(z)$ is an embedding $(-1, 1) \times \dot{\Sigma} \hookrightarrow M$, and its image never intersects any of the orbits P_z or Morse-Bott tori N_z . In particular the maps $u_\tau : \dot{\Sigma} \rightarrow M$ are embedded for each $\tau \in (-1, 1)$, with mutually disjoint images which do not intersect their asymptotic limits.
- (iii) If P_z belongs to a Morse-Bott torus N_z , then u_τ and $u_{\tau'}$ are asymptotic at z to distinct orbits in N_z whenever $\tau \neq \tau'$.
- (iv) Every \tilde{u}' sufficiently close to \tilde{u} in $\mathcal{M}_{\mathcal{H},\Lambda}$ is parametrized by $\tilde{u}_{(\sigma,\tau)}$ for some unique $\sigma \in \mathbb{R}$, $\tau \in (-1, 1)$.

From this and the smoothness of the nonlinear normal Cauchy-Riemann operator defined in [Wen], we obtain the following deformation result.

Theorem 2.7. *Suppose $\tilde{u} \in \mathcal{M}_{\mathcal{H},\Lambda}$ is as in Theorem 2.6, and*

$$\mathcal{H}_r = (\xi_r, X_r, \omega_r, J_r), \quad r \in (-1, 1)$$

is a smooth 1-parameter family of stable Hamiltonian structures such that $\mathcal{H}_0 = \mathcal{H}$, and for each $r \in (-1, 1)$, all of the orbits P_z and Morse-Bott tori N_z remain Morse-Bott orbits/tori with respect to X_r , while the surfaces L_1, \dots, L_m remain tangent to X_r .

Then there exists a number $\epsilon \in (0, 1]$ and a smooth 1-parameter family of maps

$$\tilde{F}_r : \mathbb{R} \times (-1, 1) \times \dot{\Sigma} \rightarrow \mathbb{R} \times M, \quad r \in (-\epsilon, \epsilon)$$

such that $\tilde{F}_0(0, 0, \cdot) = \tilde{u}$ and each map \tilde{F}_r has the properties of \tilde{F} in Theorem 2.6 with respect to the moduli space $\mathcal{M}_{\mathcal{H}_r,\Lambda}$.

These local perturbation theorems start from the assumption that $\tilde{u} = (a, u)$ is embedded, and usually also that u is injective. To study foliations, we need to know that such conditions are preserved under convergence to limits. One needs therefore a version of positivity of intersections for holomorphic curves with boundary: the crucial observation is that such a result holds whenever one can guarantee that all boundary intersections are ‘‘one-sided’’ (cf. [Ye98]). This is easy to show under the conditions of Theorem 2.6, where the assumptions guarantee that $\text{wind}_\pi(\tilde{u}) = 0$,

implying u is transverse to X and thus \tilde{u} is transverse to the hypersurfaces $\mathbb{R} \times L_j$.

Theorem 2.8. *Suppose $\mathcal{H}_k = (\xi_k, X_k, \omega_k, J_k)$ is a sequence of stable Hamiltonian structures converging in $C^\infty(M)$ to $\mathcal{H} = (\xi, X, \omega, J)$, such that X_k is tangent to the surfaces L_1, \dots, L_m for all k , and $\tilde{u}_k = (a_k, u_k) : \dot{\Sigma} \rightarrow \mathbb{R} \times M$ is a sequence of curves in $\mathcal{M}_{\mathcal{H}_k, \Lambda}$ such that for all k , u_k is embedded and intersects each L_j only at $\partial\Sigma$. Then if \tilde{u}_k converges in C_{loc}^∞ to a somewhere injective curve $\tilde{u} = (a, u) \in \mathcal{M}_{\mathcal{H}, \Lambda}$ with $E_\omega(\tilde{u}) > 0$ and $\text{wind}_\pi(\tilde{u}) = 0$, $u : \dot{\Sigma} \rightarrow M$ is embedded.*

Moreover, suppose $\tilde{u}_k = (a_k, u_k)$, $\tilde{v}_k = (b_k, v_k) \in \mathcal{M}_{\mathcal{H}_k, \Lambda}$ are sequences such that u_k and v_k both satisfy the conditions above, and never intersect each other. Then if $\tilde{u}_k \rightarrow \tilde{u} = (a, u)$ and $\tilde{v}_k \rightarrow \tilde{v} = (b, v)$ in C_{loc}^∞ with $E_\omega(\tilde{u})$ and $E_\omega(\tilde{v})$ both positive and $\text{wind}_\pi(\tilde{u}) = \text{wind}_\pi(\tilde{v}) = 0$, the images of u and v are either disjoint or identical.

3. COMPACTNESS

3.1. The setup. For any pair of oriented knots γ and $\gamma' \subset S^3$, denote their linking number by $\text{lk}(\gamma, \gamma') \in \mathbb{Z}$. Let $P_\infty \subset S^3$ be an oriented knot, and $K = K_1 \cup \dots \cup K_m \subset S^3 \setminus P_\infty$ an oriented link whose components satisfy $\text{lk}(P_\infty, K_j) > 0$. Each knot K_j is the center of some solid torus $N_j \subset S^3$; we assume that these solid tori are pairwise disjoint and that $N := N_1 \cup \dots \cup N_m \subset S^3$ is disjoint from P_∞ . Denote $\partial N_j = L_j$ and $M = S^3 \setminus (\text{int } N)$, so the oriented boundary of M is $\partial M = -\bigcup_j L_j$. Let $\mathcal{H}_k = (\xi_k, X_k, \omega_k, J_k)$ be a sequence of stable Hamiltonian structures on M which converge in $C^\infty(M)$ to a stable Hamiltonian structure $\mathcal{H}_\infty = (\xi_\infty, X_\infty, \omega_\infty, J_\infty)$ and have the following properties for all $k \leq \infty$:

- (1) P_∞ is a nondegenerate periodic orbit of X_k .
- (2) Any other periodic orbit $P \subset M \setminus P_\infty$ of X_k satisfies $\text{lk}(P, P_\infty) \neq 0$.
- (3) X_k is tangent to each torus L_j
- (4) There are trivializations Φ_k of $\xi_k|_M$ such that $\mu_{\mathbb{C}\mathbb{Z}}^{\Phi_k}(P_\infty) = 3$ and, if $\gamma \subset L_j$ is a positively oriented meridian, $\text{wind}_\gamma^{\Phi_k}(TL_j \cap \xi_k) = 1$.

The stable Hamiltonian structures \mathcal{H}_k define \mathbb{R} -invariant almost complex structures \tilde{J}_k on $\mathbb{R} \times M$, for which the surfaces

$$\tilde{L}_j := \{0\} \times L_j$$

are totally real submanifolds. We then consider a sequence of embedded \tilde{J}_k -holomorphic curves

$$\tilde{u}_k = (a_k, u_k) : (\dot{\Sigma}, j_k) \rightarrow (\mathbb{R} \times M, \tilde{J}_k),$$

where

$$\Sigma = S^2 \setminus \bigcup_{j=1}^m \mathcal{D}_j$$

for some set of pairwise disjoint open disks $\mathcal{D}_j \subset \mathbb{C}$, j_k is an arbitrary sequence of smooth complex structures on Σ and $\dot{\Sigma} = \Sigma \setminus \{\infty\}$. Assume

each \tilde{u}_k has finite energy with respect to \mathcal{H}_k , is positively asymptotic at ∞ to the orbit P_∞ , and satisfies the boundary condition

$$\tilde{u}_k(\gamma_j) \subset \{\text{const}\} \times L_j$$

for $\gamma_j = \partial\mathcal{D}_j$, where the constant in the \mathbb{R} -factor is arbitrary and independent for each component. Thus $\tilde{u}_k \in \mathcal{M}_{\mathcal{H}_k, \Lambda}$, where $\Lambda = (\tilde{L}_1, \dots, \tilde{L}_m)$. We assume also that the maps $u_k : \dot{\Sigma} \rightarrow M$ are all injective and have the following topological behavior at the boundary:

For each component $\gamma_j \subset \partial\Sigma$, the oriented loop $u_k(\gamma_j)$ is homotopic along L_j to a negatively oriented meridian, i.e. $\text{lk}(u_k(\gamma_j), P_\infty) = 0$ and $\text{lk}(u_k(\gamma_j), K_j) = -1$.

Remark 3.1. We've implicitly assumed thus far that L_i and L_j are disjoint when $i \neq j$, but it's convenient also to allow the possibility that K has fewer than m components. As a notational convenience, we will continue to list these components as $K_1 \cup \dots \cup K_m$, with the understanding that some of the K_j (and the corresponding N_j and L_j) may be identical. In this case different components of $\partial\Sigma$ may satisfy the same boundary condition.

Lemma 3.2. $\text{ind}(\tilde{u}_k) = 2$.

Proof. Using the global trivialization Φ_k , the boundary Maslov index at γ_j is twice the winding number of $TL_j \cap \xi_k$ along a negatively oriented meridian; this gives -2 . We then have

$$\mu(\tilde{u}_k) = \mu_{\text{CZ}}^{\Phi_k}(P_\infty) + \sum_{j=1}^m \mu_{u_k(\gamma_j)}^{\Phi_k}(u_k^* \xi_k, TL_j \cap \xi_k) = 3 - 2m,$$

hence by (2.3),

$$\text{ind}(\tilde{u}_k) = \mu(\tilde{u}_k) - \chi(\dot{\Sigma}) + m = (3 - 2m) - (1 - m) + m = 2.$$

□

Applying Theorem 2.6 to \tilde{u}_k now yields:

Corollary 3.3. *For each $\tilde{u}_k = (a_k, u_k)$, $u_k : \dot{\Sigma} \rightarrow M$ is embedded, transverse to X_k and does not intersect P_∞ . In particular then, u_k is transverse to ∂M .*

Our main goal in the next few subsections will be to prove the following.

Theorem 3.4 (Compactness). *There exists a sequence of numbers $c_k \in \mathbb{R}$ and diffeomorphisms $\varphi_k : \Sigma \rightarrow \Sigma$ which fix ∞ and preserve each component of $\partial\Sigma$, such that a subsequence of $(a_k + c_k, u_k) \circ \varphi_k$ converges in $C_{\text{loc}}^\infty(\dot{\Sigma})$ to some $\tilde{u} = (a, u) \in \mathcal{M}_{\mathcal{H}_\infty, \Lambda}$, and the continuous extensions of these maps over $\bar{\Sigma}$ converge in C^0 . Moreover, \tilde{u} is embedded and u is injective.*

A closely related result involves the degeneration of such a sequence as X_k is twisted to the point where the meridians on L_j become periodic orbits. The following will be crucial in passing from holomorphic foliations with boundary to stable finite energy foliations of Morse-Bott type:

Theorem 3.5 (Degeneration). *Assume \tilde{u}_k and \mathcal{H}_k are as described above for all $k < \infty$, but with the following change for $k = \infty$:*

Any periodic orbit P of X_∞ in $(\text{int } M) \setminus P_\infty$ satisfies $\text{lk}(P, P_\infty) \neq 0$, and each $L_j \subset \partial M$ is a Morse-Bott torus with respect to X_∞ , with orbits P satisfying $\text{lk}(P, P_\infty) = 0$ and $\text{lk}(P, K_j) = -1$.

Then there is a finite set $\Gamma' \subset \mathbb{C}$ with $\#\Gamma' = m$, a sequence of numbers $c_k \in \mathbb{R}$ and diffeomorphisms $\varphi_k : S^2 \setminus \Gamma' \rightarrow \text{int } \Sigma$ that fix ∞ , such that after passing to a subsequence, $\varphi_k^ j_k \rightarrow i$ in $C_{\text{loc}}^\infty(S^2 \setminus \Gamma')$ and $(a_k + c_k, u_k) \circ \varphi_k$ converges in $C_{\text{loc}}^\infty(\mathbb{C} \setminus \Gamma', \mathbb{R} \times M)$ to a \tilde{J}_∞ -holomorphic finite energy surface*

$$\tilde{u}_\infty : S^2 \setminus (\{\infty\} \cup \Gamma') \rightarrow \mathbb{R} \times M.$$

The map $\tilde{u}_\infty = (a_\infty, u_\infty)$ is embedded, with $u_\infty : \mathbb{C} \setminus \Gamma' \rightarrow M$ injective and disjoint from ∂M , all the punctures are positive, the asymptotic limit at $\infty \in S^2$ is P_∞ , and for each component $\gamma_j \subset \partial \Sigma$, there is a corresponding puncture $z_j \in \Gamma'$ such that the asymptotic limit at z_j is a simply covered orbit on L_j . Moreover for any sequence $\zeta_k \in \mathbb{C} \setminus \Gamma'$ approaching a puncture $z_j \in \Gamma'$, we have $u_k \circ \varphi_k(\zeta_k) \rightarrow L_j$.

3.2. Deligne-Mumford theory with boundary. Before proving the main compactness results, we briefly review the Deligne-Mumford compactification of the moduli space of Riemann surfaces with boundary and interior marked points. This space can always be identified with a space of *symmetric* surfaces without boundary, “symmetric” meaning there exists an antiholomorphic involution which is respected by all the data (see Figure 4). A more detailed discussion of this correspondence may be found in [Wen05], and for proofs of the compactness theorem we refer to [SS92, Hum97].

Let (Σ, j) be a compact connected Riemann surface, possibly with boundary, and let $\Gamma \subset \text{int } \Sigma$ be a finite *ordered* subset. As usual, denote the corresponding punctured surface by $\dot{\Sigma} = \Sigma \setminus \Gamma$. If the Euler characteristic $\chi(\dot{\Sigma}) < 0$, then we call the triple (Σ, j, Γ) a *stable Riemann surface with boundary and interior marked points*. The stability condition means

$$2g + m + \#\Gamma > 2,$$

where g is the genus of Σ and m is the number of boundary components. Equivalently, one can say that (Σ, j, Γ) is stable if the Riemann surface obtained by doubling $(\dot{\Sigma}, j)$ along its boundary has negative Euler characteristic; this definition has the advantage of also being correct when Σ has marked points on the boundary.

It is a standard fact that every Riemann surface without boundary and with negative Euler characteristic admits a unique complete metric that is compatible with the conformal structure and has constant curvature -1 : this is called the *Poincaré metric*. For a stable Riemann surface (Σ, j, Γ) with boundary, we define the Poincaré metric as the restriction to $\dot{\Sigma}$ of

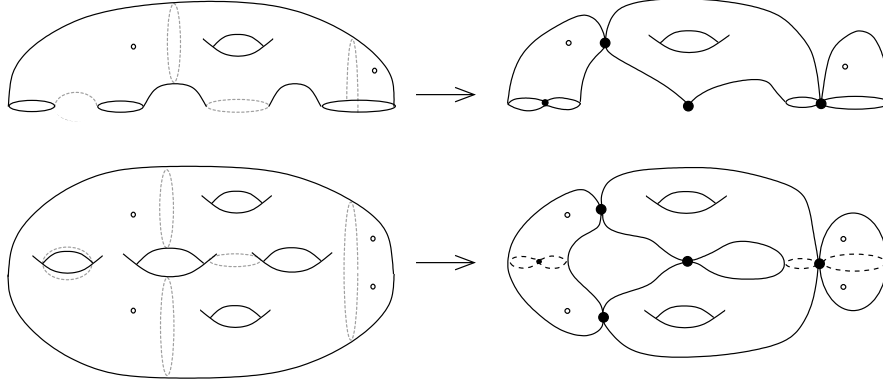

FIGURE 4. Degeneration of a stable Riemann surface (Σ, j, Γ) with genus 1, four boundary components and two interior marked points, together with its symmetric doubled surface. The lightly shaded curves on the left are the geodesic loops and arcs that shrink to zero length in the limit. The right side shows the corresponding singular surface $\widehat{\Sigma}$ and its double after degeneration; $\widehat{\Sigma}$ has one interior double point, two boundary double points and one unpaired node.

the Poincaré metric on the symmetric double of $(\dot{\Sigma}, j)$. In this way, each component of $\partial\Sigma$ becomes a geodesic.

Denote by $\mathcal{M}_{g,m,p}$ the moduli space of equivalence classes of compact connected Riemann surfaces (Σ, j, Γ) with genus g , $m \geq 0$ boundary components and $p = \#\Gamma$ interior marked points $\Gamma \subset \text{int } \Sigma$. Recall that the points of Γ come with an ordering. Equivalence $(\Sigma, j, \Gamma) \sim (\Sigma', j', \Gamma')$ means that there exists a biholomorphic map $\varphi : (\Sigma, j) \rightarrow (\Sigma', j')$ that takes Γ to Γ' , preserving the ordering. The topology on $\mathcal{M}_{g,m,p}$ is defined by saying that $[(\Sigma_k, j_k, \Gamma_k)] \rightarrow [(\Sigma, j, \Gamma)]$ if for sufficiently large k there exist diffeomorphisms $\varphi_k : \Sigma \rightarrow \Sigma_k$ mapping $\Gamma \rightarrow \Gamma_k$ (with the right ordering) and such that $\varphi_k^* j_k \rightarrow j$ in C^∞ .

A *nodal Riemann surface with boundary and interior marked points* $\Sigma = (\Sigma, j, \Gamma, \Delta, N)$ consists of a Riemann surface (Σ, j) with finitely many connected components $\Sigma = \Sigma_1 \cup \dots \cup \Sigma_q$, each of which is a compact surface, possibly with boundary. The marked point set Γ is a finite ordered set of interior points in Σ , and Δ is a set of unordered pairs of points in Σ ,

$$\Delta = \{\{z_1, z'_1\}, \dots, \{z_d, z'_d\}\},$$

called *double points*. By assumption, the points $z_1, z'_1, \dots, z_d, z'_d$ are all distinct, and $z_j \in \partial\Sigma$ if and only if $z'_j \in \partial\Sigma$. We will sometimes abuse notation and regard Δ as a subset of Σ , rather than a set of pairs. There is also a finite unordered set N of interior points, which we'll call *unpaired nodes*. We assume the sets Γ , Δ and N are all disjoint. Intuitively, one thinks of Σ as the topological space obtained from Σ by identifying each

pair of double points:

$$\widehat{\Sigma} = \Sigma / \{z_j \sim z'_j \text{ for each pair } \{z_j, z'_j\} \in \Delta\}.$$

The point in $\widehat{\Sigma}$ determined by a given pair of double points $\{z_j, z'_j\} \in \Delta$ is called a *node*. We say that Σ is *connected* whenever $\widehat{\Sigma}$ is connected. The connected components of Σ may be regarded as Riemann surfaces with boundary and marked points $(\Sigma_j, j|_{\Sigma_j}, (\Gamma \cup \Delta \cup N) \cap \Sigma_j)$, which give rise to punctured surfaces

$$\dot{\Sigma}_j = \Sigma_j \setminus ((\Gamma \cup \Delta \cup N) \cap \Sigma_j),$$

having potentially both interior and boundary punctures. We then say that Σ is *stable* if its connected components are all stable; this means each $\dot{\Sigma}_j$ has negative Euler characteristic after doubling.

The punctured components $\dot{\Sigma}_j$ can be compactified naturally as follows: for an interior puncture z , choose holomorphic coordinates identifying z with 0 in the standard unit disk, use the map $(s, t) \mapsto e^{-2\pi(s+it)}$ to identify this biholomorphically with the half-cylinder $[0, \infty) \times S^1$, and compactify by adding the ‘‘circle at infinity’’ $\delta_z \cong \{\infty\} \times S^1$. For punctures $z \in \partial\Sigma$, one instead uses the map $(s, t) \mapsto e^{-\pi(s+it)}$ to identify a punctured upper half-disk with the half strip $[0, \infty) \times [0, 1]$, and then adds the ‘‘arc at infinity’’ $\delta_z \cong \{\infty\} \times [0, 1]$. Doing this for all punctures yields a compact surface with piecewise smooth boundary. Denote by $\overline{\Sigma}_j$ the compactification of $\dot{\Sigma}_j \cup (\Gamma \cap \Sigma_j)$ obtained by adding such circles for each interior double point and unpaired node, and arcs for each boundary double point in Σ_j .

Given a nodal surface $(\Sigma, j, \Gamma, \Delta, N)$, an *asymptotic marker* at $z \in \Delta \cap \text{int } \Sigma$ is a choice of direction $\mu \in (T_z \Sigma \setminus \{0\})/\mathbb{R}_+$, where \mathbb{R}_+ is the group of positive real numbers, acting by scalar multiplication. A choice of asymptotic markers $r = \{\{\mu_1, \mu'_1\}, \dots, \{\mu_d, \mu'_d\}\}$ for every pair of interior double points is called a *decoration*, and we then call $(\Sigma, r) = (\Sigma, j, \Gamma, \Delta, N, r)$ a *decorated nodal Riemann surface*. For each pair $\{z, z'\} \in \Delta$ with asymptotic markers $\{\mu, \mu'\}$, the conformal structure j determines a natural choice of orientation reversing map

$$r_z : (T_z \Sigma \setminus \{0\})/\mathbb{R}_+ \rightarrow (T_{z'} \Sigma \setminus \{0\})/\mathbb{R}_+$$

such that $r_z(\mu) = \mu'$, and hence also an orientation reversing diffeomorphism $\bar{r}_z : \delta_z \rightarrow \delta_{z'}$. For boundary pairs $\{z, z'\}$, the boundary determines natural asymptotic markers and thus diffeomorphisms \bar{r}_z between the arcs δ_z and $\delta_{z'}$. Then define

$$\overline{\Sigma}_r = (\overline{\Sigma}_1 \sqcup \dots \sqcup \overline{\Sigma}_q) / \{w \sim \bar{r}_z(w) \text{ for all } w \in \delta_z, z \in \Delta \cup N\}.$$

This is a compact surface with smooth boundary, and is connected if and only if $\widehat{\Sigma}$ is connected. In that case, we define the *arithmetic signature* of Σ to be the pair (g, m) where g is the genus of $\overline{\Sigma}_r$ (the *arithmetic genus* of Σ) and m is the number of connected components of $\partial\overline{\Sigma}_r$. We shall denote the union of the special circles and arcs δ_z for $z \in \Delta \cup N$ by $\Theta_{\Delta, N} \subset \overline{\Sigma}_r$.

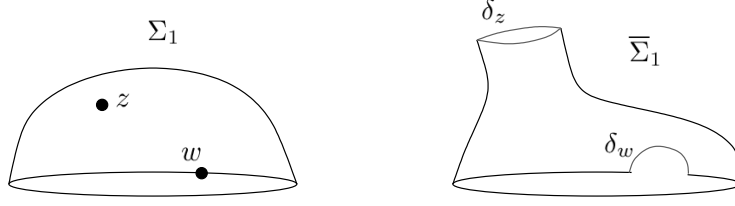

FIGURE 5. A component Σ_1 with its compactification $\bar{\Sigma}_1$. Here there's one interior double point $z \in \Delta \cap \text{int } \Sigma_1$ and one boundary double point $w \in \Delta \cap \partial \Sigma_1$.

The conformal structure j on Σ defines a singular conformal structure j_{Σ} on $\bar{\Sigma}_r$, which degenerates at $\Theta_{\Delta, N}$. If Σ is stable, then there is similarly a ‘‘singular Poincaré metric’’ h_{Σ} on $\bar{\Sigma}_r \setminus \Gamma$, defined by choosing the Poincaré metric on each of the punctured components $\dot{\Sigma}_j$. This metric degenerates at $\Theta_{\Delta, N}$ as well as at Γ ; in particular the distance from a marked point $z_0 \in \Gamma$ or a circle or arc $\delta_z \subset \Theta_{\Delta, N}$ to any other point in $\bar{\Sigma}_r$ is infinite, and the circles and arcs δ_z have length 0. Observe that in the stable case, $\chi(\bar{\Sigma}_r \setminus \Gamma) < 0$, i.e. a stable nodal surface $(\Sigma, j, \Gamma, \Delta, N)$ with arithmetic signature (g, m) satisfies $2g + m + \#\Gamma > 2$.

Assume $2g + m + p > 2$ and let $\overline{\mathcal{M}}_{g, m, p}$ denote the moduli space of equivalence classes of stable nodal Riemann surfaces $\Sigma = (\Sigma, j, \Gamma, \Delta, N)$ with arithmetic signature (g, m) and $p = \#\Gamma$ interior marked points. We say $(\Sigma, j, \Gamma, \Delta, N) \sim (\Sigma', j', \Gamma', \Delta', N')$ if there is a biholomorphic map $\varphi : (\Sigma, j) \rightarrow (\Sigma', j')$ taking Γ to Γ' with the proper ordering, and such that $\varphi(N) = N'$ and $\{\varphi(z_1), \varphi(z_2)\} \in \Delta'$ if and only if $\{z_1, z_2\} \in \Delta$. There is a natural inclusion $\mathcal{M}_{g, m, p} \hookrightarrow \overline{\mathcal{M}}_{g, m, p}$ defined by assigning to $[(\Sigma, j, \Gamma)]$ an empty set of double points and unpaired nodes.

The topology of $\overline{\mathcal{M}}_{g, m, p}$ is determined by the following notion of convergence.

Definition 3.6. A sequence $[\Sigma_k] = [(\Sigma_k, j_k, \Gamma_k, \Delta_k, N_k)] \in \overline{\mathcal{M}}_{g, m, p}$ converges to $[\Sigma] = [(\Sigma, j, \Gamma, \Delta, N)] \in \overline{\mathcal{M}}_{g, m, p}$ if there are decorations r_k for Σ_k and r for Σ , and diffeomorphisms $\varphi_k : \bar{\Sigma}_r \rightarrow (\bar{\Sigma}_k)_{r_k}$, for sufficiently large k , with the following properties:

- (1) φ_k sends Γ to Γ_k , preserving the ordering.
- (2) $\varphi_k^* j_{\Sigma_k} \rightarrow j_{\Sigma}$ in $C_{\text{loc}}^{\infty}(\bar{\Sigma}_r \setminus \Theta_{\Delta, N})$.
- (3) $\varphi_k^{-1}(\Theta_{\Delta_k, N_k}) \subset \Theta_{\Delta, N}$, and all circles in $\varphi_k(\Theta_{\Delta, N}) \setminus \Theta_{\Delta_k, N_k}$ are closed geodesics for the Poincaré metric h_{Σ_k} on $(\bar{\Sigma}_k)_{r_k}$; similarly all arcs in $\varphi_k(\Theta_{\Delta, N}) \setminus \Theta_{\Delta_k, N_k}$ are geodesic arcs with endpoints on $\partial((\bar{\Sigma}_k)_{r_k})$.

Theorem 3.7. $\overline{\mathcal{M}}_{g, m, p}$ is compact. In particular, any sequence of stable Riemann surfaces $(\Sigma_k, j_k, \Gamma_k)$ with boundary and interior marked points, having fixed topological type and number of marked points, has a subsequence convergent (in the sense of Definition 3.6) to a stable nodal Riemann surface $(\Sigma, j, \Gamma, \Delta, N)$ with boundary and interior marked points.

3.3. Preparation and removal of singularities. In this section, fix a closed 3-manifold M with stable Hamiltonian structure $\mathcal{H} = (\xi, X, \omega, J)$ and an embedded surface $L \subset M$ tangent to X . Let $\mathbb{H} \subset \mathbb{C}$ denote the closed upper half-plane, and $\mathbb{D}^+ := \mathbb{D} \cap \mathbb{H}$. We now collect some lemmas that will be useful in the compactness arguments to come.

Lemma 3.8 ([HZ94], Sec. 6.4, Lemma 5). *Let (X, d) be a complete metric space and $f : X \rightarrow [0, \infty)$ a continuous function. Then given any $x_0 \in X$ and $\epsilon_0 > 0$, there exist $x \in \overline{B_{2\epsilon_0}(x_0)}$ and $\epsilon \in (0, \epsilon_0]$ such that*

$$f(x)\epsilon \geq f(x_0)\epsilon_0 \quad \text{and} \quad f(y) \leq 2f(x) \text{ for all } y \in \overline{B_\epsilon(x)}.$$

The next statement follows from the fact that when $\tilde{u} = (a, u) : \dot{\Sigma} \rightarrow \mathbb{R} \times M$ is a finite energy surface, the map a is both proper and subharmonic (cf. [HWZ95a]). Note however that in non-contact cases, there can generally exist nonconstant *closed* \tilde{J} -holomorphic curves in $\mathbb{R} \times M$.

Lemma 3.9. *Every finite energy surface with nonremovable punctures and no boundary has at least one positive puncture.*

Lemma 3.10. *Suppose (Σ, j) is a simply connected Riemann surface and $\tilde{u} = (a, u) : (\Sigma, j) \rightarrow (\mathbb{R} \times M, \tilde{J})$ is pseudoholomorphic with $E_\omega(\tilde{u}) = 0$. Then \tilde{u} has the form*

$$\tilde{u}(z) = (a(z), x(f(z)))$$

where $x : \mathbb{R} \rightarrow M$ is an orbit of X (not necessarily periodic) and $a + if : \Sigma \rightarrow \mathbb{C}$ is a holomorphic function.

Proof. The integrand of $E_\omega(\tilde{u}) = \int_\Sigma u^* \omega$ is everywhere nonnegative, and vanishes at $z \in \Sigma$ if and only if the image of $du(z)$ is contained in $\mathbb{R}X(u(z))$. By assumption this is true everywhere, thus $u(\Sigma)$ is contained in the image of some orbit $x : \mathbb{R} \rightarrow M$ of X . If x is not periodic, then it's a diffeomorphism onto its image and can be inverted, allowing us to find a function $f : \Sigma \rightarrow \mathbb{R}$ such that $u = x \circ f$. If x is periodic, then it can be viewed as a covering map onto its image, and the simple connectedness of Σ means that u can be lifted to the cover, producing again the map f . An easy computation now shows that $\tilde{u} = (a, u)$ is \tilde{J} -holomorphic if and only if $a + if$ satisfies the standard Cauchy-Riemann equations. \square

Proposition 3.11. *Suppose $\tilde{u} : \Sigma \rightarrow \mathbb{R} \times M$ is \tilde{J} -holomorphic with finite energy $E(\tilde{u}) < \infty$, $E_\omega(\tilde{u}) = 0$ and $\tilde{u}(\partial\Sigma) \subset \{0\} \times L$.*

- (1) *If Σ is S^2 , \mathbb{D} , \mathbb{C} or \mathbb{H} , then \tilde{u} is constant.*
- (2) *If Σ is $\mathbb{R} \times S^1$ or $(-\infty, 0] \times S^1$, there exists a number $Q \in \mathbb{R}$ and an orbit $x : \mathbb{R} \rightarrow M$ of X such that up to \mathbb{R} -translation, $\tilde{u}(s, t) = (Qs, x(Qt))$.*

Proof. Applying Lemma 3.10, the function a is harmonic, and constant on the boundary. For the compact cases $\Sigma = S^2$ and \mathbb{D} this is enough: we conclude that a is globally constant, and so therefore is f , its harmonic conjugate.

For $\Sigma = \mathbb{C}$, an argument from [Hof93, Lemma 28] uses the finiteness of $E_\lambda(\tilde{u})$ to show that $\Phi := a + if$ is constant. In brief, the energy can be rewritten as

$$E_\lambda(\tilde{u}) = \sup_{\varphi \in \mathcal{T}} \int_{\mathbb{C}} \tilde{u}^*(d\varphi \wedge \lambda) = \sup_{\varphi \in \mathcal{T}} \int_{\mathbb{C}} \Phi^* d(\varphi(s) dt),$$

and a bubbling off argument shows that Φ must be constant if the latter is finite. We use this argument also for the case $\Sigma = \mathbb{H}$, after observing that the boundary condition implies $\Phi(\mathbb{R}) \subset i\mathbb{R}$, so Φ extends by the Schwartz reflection principle to an entire function on \mathbb{C} .

The cylinder cases also follow from arguments in [Hof93]: a simple bubbling off argument using the finite energy shows that $|d\tilde{u}|$ is globally bounded, and we then lift the domain to \mathbb{C} or \mathbb{H} and apply Lemma 3.10. The holomorphic function $\Phi = a + if$ need not be constant in this case but is affine due to the gradient bound, so periodicity in t implies $\Phi(s, t) = Qs + c + iQt$ for some constants $Q, c \in \mathbb{R}$, and x is $|Q|$ -periodic unless $Q = 0$. \square

We will often use the fact that interior punctures of holomorphic curves with finite energy are either asymptotic to periodic orbits or are removable; the latter is the case whenever the image is contained within a compact subset of $\mathbb{R} \times M$. This follows from the standard theorem on removal of singularities (cf. [MS04]), together with the following observation: if $\varphi : \mathbb{R} \rightarrow (0, \epsilon)$ is a smooth increasing function and ϵ is sufficiently small, then

$$(3.1) \quad d(\varphi\lambda) + \omega$$

is a symplectic form on $\mathbb{R} \times M$, and any \tilde{J} -holomorphic map \tilde{u} with $E(\tilde{u}) < \infty$ also has finite symplectic area with respect to this form.

We will need a corresponding statement for boundary punctures. Since our usual boundary condition on curves $\tilde{u} : \dot{\Sigma} \rightarrow \mathbb{R} \times M$ constrains $\tilde{u}(\partial\Sigma)$ to lie in a compact submanifold of $\mathbb{R} \times M$, one expects boundary punctures to be removable. One only needs to show that such maps cannot become unbounded on the interior in a neighborhood of a puncture; we will show that this is always the case when the boundary condition has the form $\tilde{L} = \{\text{const}\} \times L$.¹

Theorem 3.12 (Removal of boundary singularities). *Suppose $\tilde{u} = (a, u) : \dot{\mathbb{D}}^+ = \mathbb{D}^+ \setminus \{0\} \rightarrow \mathbb{R} \times M$ is a \tilde{J} -holomorphic map with $E(\tilde{u}) < \infty$ and $\tilde{u}(\dot{\mathbb{D}}^+ \cap \mathbb{R}) \subset \{0\} \times L$. Then \tilde{u} extends to a \tilde{J} -holomorphic half-disk $\mathbb{D}^+ \rightarrow \mathbb{R} \times M$ with $\tilde{u}(\mathbb{D}^+ \cap \mathbb{R}) \subset \{0\} \times L$.*

Proof. By the remarks above, the result will follow from the standard removal of singularities theorem after showing that $\tilde{u}(\dot{\mathbb{D}}^+)$ is contained in a

¹As shown in [Wen05], a somewhat more general statement is true, but it's not clear whether these arguments can be generalized to accommodate arbitrary graphs $\tilde{L} = \{(g(x), x) \in \mathbb{R} \times L\}$.

compact subset of $\mathbb{R} \times M$. To see that this is the case, compose \tilde{u} with the biholomorphic map $\psi : [0, \infty) \times [0, 1] \rightarrow \mathbb{D}^+ : (s, t) \mapsto e^{-\pi(s+it)}$ and consider the pseudoholomorphic half-strip

$$\tilde{v} = (b, v) = \tilde{u} \circ \psi : [0, \infty) \times [0, 1] \rightarrow \mathbb{R} \times M.$$

We claim that $|d\tilde{v}|$ is bounded on $[0, \infty) \times [0, 1]$, where the norm is defined with respect to the Euclidean metric on $[0, \infty) \times [0, 1] \subset \mathbb{C}$ and any fixed \mathbb{R} -invariant metric on $\mathbb{R} \times M$. It will follow from this that \tilde{v} (and hence \tilde{u}) is bounded, as $\tilde{v}([0, \infty) \times \{0\})$ and $\tilde{v}([0, \infty) \times \{1\})$ are contained in the compact set $\{0\} \times L$.

If $|d\tilde{v}|$ is not bounded, there is a sequence $z_k = s_k + it_k \in [0, \infty) \times [0, 1] \subset \mathbb{C}$ such that $R_k := |d\tilde{v}(z_k)| \rightarrow \infty$. We may assume $s_k \rightarrow \infty$. Choose a sequence of positive numbers $\epsilon_k \rightarrow 0$ such that $\epsilon_k R_k \rightarrow \infty$; by Lemma 3.8 we can assume without loss of generality that $|d\tilde{v}(z)| \leq 2|d\tilde{v}(z_k)|$ whenever $|z - z_k| \leq \epsilon_k$. We will define a sequence of rescaled maps which converge to either a plane or a half-plane, depending on whether and how fast z_k approaches the boundary of $[0, \infty) \times [0, 1]$. We consider three cases.

Case 1: assume $t_k R_k$ and $(1 - t_k)R_k$ are both unbounded: then we can pass to a subsequence so that both approach ∞ . Let

$$r_k := \min\{\epsilon_k R_k, t_k R_k, (1 - t_k)R_k\},$$

so $r_k \rightarrow \infty$ and there are embeddings

$$\psi_k : \mathbb{D}_{r_k} \hookrightarrow [0, \infty) \times [0, 1] : z \mapsto z_k + \frac{z}{R_k}.$$

Use these to define rescaled maps

$$\tilde{v}_k = (b \circ \psi_k - b(z_k), v \circ \psi_k) : \mathbb{D}_{r_k} \rightarrow \mathbb{R} \times M,$$

which satisfy a uniform C^1 -bound and have a subsequence convergent in C_{loc}^∞ to a non-constant \tilde{J} -holomorphic plane $\tilde{v}_\infty : \mathbb{C} \rightarrow \mathbb{R} \times M$. This map has finite energy $E(\tilde{v}_\infty) \leq E(\tilde{v}) < \infty$, but also $E_\omega(\tilde{v}_\infty) = 0$, giving a contradiction to Prop 3.11.

Case 2: assume $t_k R_k$ is bounded. This means z_k is approaching the half-line $[0, \infty) \times \{0\}$. Let

$$\psi_k : \mathbb{D}_{\epsilon_k R_k}^+ \hookrightarrow [0, \infty) \times [0, 1] : z \mapsto s_k + \frac{z}{R_k},$$

and define a sequence of rescaled maps $\tilde{v}_k : \mathbb{D}_{\epsilon_k R_k}^+ \rightarrow \mathbb{R} \times M$ by $\tilde{v}_k = \tilde{v} \circ \psi_k$. These maps satisfy the boundary condition $\tilde{v}_k(\mathbb{D}_{\epsilon_k R_k}^+ \cap \mathbb{R}) \subset \{0\} \times L$. Moreover, the points $\tilde{v}_k(0) = \tilde{v}(s_k)$ are contained in the compact set $\{0\} \times L$, and there is a uniform gradient bound $|d\tilde{v}_k(z)| \leq 2$ for all $z \in \mathbb{D}_{\epsilon_k R_k}^+$. Thus a subsequence converges in $C_{\text{loc}}^\infty(\mathbb{H}, \mathbb{R} \times M)$ to a \tilde{J} -holomorphic half-plane $\tilde{v}_\infty : \mathbb{H} \rightarrow \mathbb{R} \times M$ with $E(\tilde{v}_\infty) < \infty$ and $E_\omega(\tilde{v}_\infty) = 0$. We claim however that \tilde{v}_∞ is not constant. Indeed, $|\psi_k^{-1}(z_k)| = R_k |z_k - s_k| = t_k R_k$ is bounded, thus passing to a subsequence, $\psi_k^{-1}(z_k) \rightarrow \zeta \in \mathbb{H}$, and $|d\tilde{v}_\infty(\zeta)| = \lim_k |d\tilde{v}_k(\psi_k^{-1}(z_k))| = 1$. Thus the existence of \tilde{v}_∞ again contradicts Prop 3.11.

Case 3: assume $(1-t_k)R_k$ is bounded. This is very similar to the previous case; this time z_k is approaching the half-line $[0, \infty) \times \{1\}$, so we rescale using the embeddings

$$\psi_k : \mathbb{D}_{\epsilon_k R_k}^+ \hookrightarrow [0, \infty) \rightarrow [0, 1] : z \mapsto (s_k + i) - \frac{z}{R_k}.$$

Then by the same arguments used above, $\tilde{v}_k = \tilde{v} \circ \psi_k$ has a subsequence convergent to a non-constant finite energy half-plane $\tilde{v}_\infty : \mathbb{H} \rightarrow \mathbb{R} \times M$ with boundary condition $\tilde{v}_\infty(\mathbb{R}) \subset \{0\} \times L$ and $E_\omega(\tilde{v}_\infty) = 0$, giving another contradiction. \square

3.4. Taming forms and energy bounds. We now proceed toward the proofs of Theorems 3.4 and 3.5, so let M , K , L_j , \mathcal{H}_k and \tilde{u}_k be as defined in §3.1. Observe that since X_k is always tangent to the tori L_j , the 2-forms $d\lambda_k$ and ω_k arising from \mathcal{H}_k vanish on L_j .

Lemma 3.13. *The taming forms ω_k for $k \leq \infty$ are exact on M .*

Proof. Applying a Mayer-Vietoris sequence to $S^3 = M \cup N$, $H_2(M)$ is generated by the inclusions of the fundamental classes $[L_j] \in H_2(L_j)$ for $j = 1, \dots, m$. Then $\int_{L_j} \omega_k = 0$ implies that ω_k vanishes on $H_2(M; \mathbb{R})$, hence $[\omega_k] = 0 \in H^2(M; \mathbb{R})$. \square

Denote by $E_k(\tilde{u}_k)$ the energy of \tilde{u}_k , computed with respect to ω_k and λ_k . Surfaces of the form $\{\text{const}\} \times L_j$ are not only totally real in $(\mathbb{R} \times M, \tilde{J})$ but also *Lagrangian* with respect to natural symplectic forms as in (3.1). This will permit a uniform energy bound for the sequence \tilde{u}_k .

Lemma 3.14. *$\int_{\tilde{\Sigma}} u_k^* \omega_k$ is uniformly bounded for all k .*

Proof. Since ω_k is exact and vanishes on each torus L_j , $\int_{\tilde{\Sigma}} u_k^* \omega_k$ depends only on the asymptotic behavior and the homotopy class of $u_k|_{\partial \tilde{\Sigma}} : \partial \tilde{\Sigma} \rightarrow \partial M$. Thus we can pick any smooth map $u : \tilde{\Sigma} \rightarrow M$ with the proper behavior and write $\int_{\tilde{\Sigma}} u_k^* \omega_k = \int_{\tilde{\Sigma}} u^* \omega_k \rightarrow \int_{\tilde{\Sigma}} u^* \omega_\infty$. \square

Lemma 3.15. *There exists a constant $C > 0$ independent of k such that $|u^* d\lambda_k| \leq C \cdot u^* \omega_k$ for every \tilde{J}_k -holomorphic curve $\tilde{u} = (a, u)$ in $\mathbb{R} \times M$.*

Proof. Let $C_k > 0$ be the C^0 -norm of the bilinear form

$$\xi_k \times \xi_k \rightarrow \mathbb{R} : (v, w) \mapsto d\lambda_k(v, J_k w)$$

on the bundle $\xi_k \rightarrow M$ with respect to the bundle metric $|v|_k^2 := \omega_k(v, J_k v)$; this is finite since M is compact. Since ω_k and λ_k each converge in C^∞ as $k \rightarrow \infty$, the sequence C_k is also bounded, $C_k \leq C$. Denote by $\pi_k : TM \rightarrow \xi_k$ the projection along X_k , and note that both $d\lambda_k$ and ω_k annihilate X_k . Then in any local holomorphic coordinate system (s, t) on the domain,

$$\begin{aligned} |u^* d\lambda_k(\partial_s, \partial_t)| &= |d\lambda_k(\pi_k u_s, \pi_k u_t)| = |d\lambda_k(\pi_k u_s, J_k \pi_k u_s)| \leq C_k |\pi_k u_s|_k^2 \\ &\leq C \cdot \omega_k(\pi_k u_s, J_k \pi_k u_s) = C \cdot \omega_k(\pi_k u_s, \pi_k u_t) = C \cdot u_k^* \omega_k(\partial_s, \partial_t). \end{aligned}$$

\square

Proposition 3.16. *There exists a constant $C > 0$ such that $E_k(\tilde{u}_k) < C$.*

Proof. Writing $E_k(\tilde{u}_k) = E_{\omega_k}(\tilde{u}_k) + E_{\lambda_k}(\tilde{u}_k)$, the first term is uniformly bounded due to Lemma 3.14. The second is $\sup_{\varphi \in \mathcal{T}} E_{\lambda_k}^\varphi(\tilde{u}_k)$, where

$$E_{\lambda_k}^\varphi(\tilde{u}_k) := \int_{\dot{\Sigma}} \tilde{u}_k^*(d\varphi \wedge \lambda_k).$$

Writing $d(\varphi\lambda_k) = \varphi d\lambda_k + d\varphi \wedge \lambda_k$, then applying Stokes' theorem, Lemma 3.15 and the fact that a_k is locally constant at $\partial\Sigma$, we have

$$\begin{aligned} |E_{\lambda_k}^\varphi(\tilde{u}_k)| &\leq \left| \int_{\dot{\Sigma}} \tilde{u}_k^*(\varphi d\lambda_k) \right| + \left| \int_{\dot{\Sigma}} \tilde{u}_k^*d(\varphi\lambda_k) \right| \\ &\leq \int_{\dot{\Sigma}} |\varphi \circ a_k| \cdot |u_k^*d\lambda_k| + \int_{P_\infty} \lambda_k + \left| \int_{\partial\Sigma} \tilde{u}_k^*(\varphi\lambda_k) \right| \\ &\leq C \int_{\dot{\Sigma}} u_k^*\omega_k + T_k + \left| \int_{\partial\Sigma} u_k^*\lambda_k \right|, \end{aligned}$$

where T_k is the period of P_∞ as an orbit of X_k . This is clearly bounded as $k \rightarrow \infty$, and so is the first term, by Lemma 3.14; it remains only to bound $\int_{\partial\Sigma} u_k^*\lambda_k$. Here we use the fact that $d\lambda_k(X_k, \cdot) \equiv 0$, hence $d\lambda_k$ annihilates each L_j , and this integral therefore only depends on λ_k and $[u_k|_{\partial\Sigma}] = \ell \in H_1(L_1 \cup \dots \cup L_m)$. In particular, it approaches $\int_\ell \lambda_\infty$ as $k \rightarrow \infty$. \square

3.5. Bubbling. In this section we establish uniform bounds on the first derivatives of the maps \tilde{u}_k . In the *non-stable* ($m < 2$) case, the arguments of this section suffice to prove C_{loc}^∞ -convergence. For $m \geq 2$, we also need to ensure that the sequence of conformal structures induced by j_k is compact; this issue will be dealt with in §3.6. The fundamental argument is that any gradient blow up causes the bubbling off of a holomorphic plane or disk, which for topological reasons cannot exist.

We focus first on the stable case, thus assume $m \geq 2$, $\chi(\dot{\Sigma}) < 0$. Then each of the stable Riemann surfaces $(\Sigma, j_k, \{\infty\})$ determines a Poincaré metric h_k , which is the restriction of a complete metric h_k^D of constant curvature -1 on the Riemann surface

$$(\dot{\Sigma}^D, j_k^D),$$

obtained by doubling $(\dot{\Sigma}, j_k)$ along the boundary. Denote the injectivity radius of h_k^D at any point $z \in \dot{\Sigma}$ by $\text{inrad}_k(z)$.

Fix any metric on M and extend it to an \mathbb{R} -invariant metric on $\mathbb{R} \times M$ in the natural way. In the following, we will always use the Euclidean metric on subsets of \mathbb{C} or $\mathbb{R} \times S^1$, and one of the Poincaré metrics h_k on $\dot{\Sigma}$, with dependence on k reflected in the notation. So for instance, given $\tilde{u} : \dot{\Sigma} \rightarrow \mathbb{R} \times M$, $|d\tilde{u}(z)|_k$ is the norm of the linear map $d\tilde{u}(z) : T_z\dot{\Sigma} \rightarrow T_{\tilde{u}(z)}(\mathbb{R} \times M)$ with respect to h_k and the fixed metric on $\mathbb{R} \times M$. For $\varphi : \mathbb{D} \rightarrow \dot{\Sigma}$, define $|d\varphi(z)|_k$ with respect to the Euclidean metric on the domain and h_k on the target.

The following technical lemma provides good coordinates in a neighborhood of any point $z_0 \in \dot{\Sigma}$. They are constructed by lifting $\dot{\Sigma}$ to the hyperbolic open disk so that 0 covers z_0 , then projecting the embedding $\mathbb{D} \hookrightarrow \text{int } \mathbb{D} : z \mapsto rz$ for sufficiently small $r > 0$ down to $\dot{\Sigma}$. It follows from the hyperbolic geometry of the disk that the resulting embedding has the desired properties; see [Wen05] for details. Denote by \mathbb{D}_ρ the standard closed disk of radius $\rho > 0$ in \mathbb{C} .

Lemma 3.17. *Let $(\dot{\Sigma}, j)$ be a stable punctured Riemann surface without boundary, with Poincaré metric h , whose injectivity radius at $z \in \dot{\Sigma}$ we denote by $\text{injrads}(z)$. There are positive constants c_i and C_i depending only on the topological type of $\dot{\Sigma}$ (i.e. not on j), such that the following is true: for any $z_0 \in \dot{\Sigma}$ and any geodesic γ passing through z_0 , there is a holomorphic embedding $\varphi : \mathbb{D} \hookrightarrow \dot{\Sigma}$ such that $\varphi(0) = z_0$, φ maps $\mathbb{R} \cap \mathbb{D}$ to γ preserving orientation, and*

$$(3.2) \quad c_1 \cdot \text{injrads}(z_0) \leq |d\varphi(z)|_h \leq C_1 \cdot \text{injrads}(z_0) \quad \text{for all } z \in \mathbb{D}.$$

For any $\rho \in [0, 1]$, the image $\varphi(\mathbb{D}_\rho)$ is then a closed ball of radius $d(\rho)$ in $(\dot{\Sigma}, h)$, where

$$(3.3) \quad c_2 \rho \cdot \text{injrads}(z_0) \leq d(\rho) \leq C_2 \rho \cdot \text{injrads}(z_0),$$

and the injectivity radius at any point $\varphi(w)$ for $w \in \mathbb{D}$ with $|w| = \rho$ can be estimated by

$$(3.4) \quad (c_3 - c_4 \rho) \cdot \text{injrads}(z_0) \leq \text{injrads}(\varphi(w)) \leq (1 + C_3 \rho) \cdot \text{injrads}(z_0)$$

Remark 3.18. Lemma 3.17 extends to surfaces $\dot{\Sigma}$ with nonempty boundary as follows: for any $z_0 \in \partial \Sigma$, the component $\gamma \subset \partial \Sigma$ containing z_0 is a closed geodesic in the doubled surface $(\dot{\Sigma}^D, h^D)$. Thus the lemma gives an embedding $\varphi : \mathbb{D}^+ \rightarrow \dot{\Sigma}$ of the upper half disk, sending 0 to z_0 and $\mathbb{R} \cap \mathbb{D}^+$ into $\partial \Sigma$.

The first main objective in this section is the following result, which says in effect that there is no bubbling off in the sequence \tilde{u}_k .

Proposition 3.19. *If $\chi(\dot{\Sigma}) < 0$, then there is a constant $C > 0$ such that*

$$(3.5) \quad |d\tilde{u}_k(z)|_k \leq \frac{C}{\text{injrads}_k(z)}$$

for all $z \in \dot{\Sigma}$ and all k .

Proof. Assume there exists a sequence $z_k \in \dot{\Sigma}$ such that $\text{injrads}_k(z_k) \cdot |d\tilde{u}_k(z_k)|_k \rightarrow \infty$. Using Lemma 3.17, choose a sequence of holomorphic embeddings

$$\varphi_k : \mathbb{D} \hookrightarrow \dot{\Sigma}^D$$

such that $|d\varphi_k|_k$, the radii of the disks $\varphi_k(\mathbb{D})$ and the injectivity radius satisfy the bounds specified in the lemma. Let

$$\rho_k = \min \{ |\zeta| \mid \zeta \in \varphi_k^{-1}(\partial \Sigma) \},$$

or $\rho_k = \infty$ if $\varphi_k(\mathbb{D}) \cap \partial\Sigma = \emptyset$. The sequence ρ_k determines whether or not we can restrict the embeddings φ_k in a uniform way so that their images are in $\dot{\Sigma}$.

Case 1: assume there is a number $\rho \in (0, 1]$ and a subsequence for which $\rho_k \geq \rho$. Then the restrictions of φ_k to \mathbb{D}_ρ are embeddings into $\dot{\Sigma}$, and we can define a sequence of pseudoholomorphic disks

$$\tilde{v}_k = (b_k, v_k) = \tilde{u}_k \circ \varphi_k : \mathbb{D}_\rho \rightarrow \mathbb{R} \times S^3,$$

which satisfy a uniform energy bound

$$E_k(\tilde{v}_k) \leq E_k(\tilde{u}_k) \leq C.$$

Denoting the Euclidean metric on \mathbb{D} by η , the fact that $\varphi_k : (\mathbb{D}_\rho, \eta) \rightarrow (\dot{\Sigma}, h_k)$ is conformal implies that the norms of $d\varphi_k(z)$ and its inverse are reciprocals. Then a simple computation shows

$$|d\tilde{v}_k(0)| = |d\tilde{u}_k(z_k)|_k \cdot |d\varphi_k(0)|_k \geq c_1 |d\tilde{u}_k(z_k)|_k \cdot \text{inrad}_k(z_k) \rightarrow \infty.$$

By Lemma 3.8, we can choose a sequence $\zeta_k \in \mathbb{D}_\rho$ and positive numbers $\epsilon_k \rightarrow 0$ such that $R_k := |d\tilde{v}(\zeta_k)| \rightarrow \infty$, $\epsilon_k R_k \rightarrow \infty$ and $|d\tilde{v}(\zeta)| \leq 2R_k$ for all $\zeta \in \mathbb{D}_\rho$ with $|\zeta - \zeta_k| \leq \epsilon_k$. Assume without loss of generality that $\overline{B_{\epsilon_k}(\zeta_k)} \subset \mathbb{D}_\rho$ and define

$$\psi_k : \mathbb{D}_{\epsilon_k R_k} \rightarrow \overline{B_{\epsilon_k}(\zeta_k)} : \zeta \rightarrow \zeta_k + \frac{\zeta}{R_k}.$$

Then we can define a rescaled sequence of \tilde{J}_k -holomorphic maps $\tilde{w}_k = (\beta_k, w_k) : \mathbb{D}_{\epsilon_k R_k} \rightarrow \mathbb{R} \times S^3$ by

$$(\beta_k(\zeta), w_k(\zeta)) = (b_k \circ \psi_k(\zeta) - b_k(\zeta_k), v_k \circ \psi_k(\zeta)).$$

These satisfy the uniform gradient bound $|d\tilde{w}_k(\zeta)| \leq 2$, and they all map 0 into a compact subset of $\mathbb{R} \times S^3$, thus a subsequence converges in C_{loc}^∞ to a \tilde{J}_∞ -holomorphic plane

$$\tilde{w}_\infty = (\beta_\infty, w_\infty) : \mathbb{C} \rightarrow \mathbb{R} \times S^3.$$

The bound on $E_k(\tilde{v}_k)$ gives also a bound on $E_k(\tilde{w}_k)$ and thus implies $E_\infty(\tilde{w}_\infty) < \infty$, so \tilde{w}_∞ is a non-constant finite energy plane.

If the puncture at ∞ is removable, \tilde{w}_∞ extends to a nonconstant \tilde{J}_∞ -holomorphic sphere in $\mathbb{R} \times M$. Recall now that ξ_∞ admits a global trivialization over M , thus $c_1(w_\infty^* \xi_\infty) = 0$ and we have

$$\text{ind}(\tilde{w}_\infty) = \mu(\tilde{w}_\infty) - \chi(S^2) = 2c_1(w_\infty^* \xi_\infty) - 2 = -2.$$

Since \tilde{w}_∞ is nonconstant, it cannot have $E_{\omega_\infty}(\tilde{w}_\infty) = 0$, by Prop. 3.11. Thus $E_{\omega_\infty}(\tilde{w}_\infty) > 0$ and Theorem 2.4 gives a contradiction, in the form

$$0 \leq 2 \text{wind}_\pi(\tilde{w}_\infty) \leq \text{ind}(\tilde{w}_\infty) - 2 = -4.$$

It remains to find a contradiction in the case of a non-removable puncture at ∞ : then \tilde{w}_∞ is asymptotic to some periodic orbit P of X_∞ . We now use a topological argument to show that this is impossible.

If P is geometrically distinct from P_∞ , then $\text{lk}(P, P_\infty) \neq 0$ by assumption. For some large radius R , the image $w_\infty(\partial\mathbb{D}_R)$ is uniformly close to P , and we may assume the same is true of $P' := w_k(\partial\mathbb{D}_R)$ for sufficiently large k , thus $\text{lk}(P', P_\infty) \neq 0$. But since w_k is a reparametrization of $u_k : \dot{\Sigma} \rightarrow S^3$ over some disk, this means there is a disk $\mathcal{D} \subset \dot{\Sigma}$ such that $P' = u_k(\partial\mathcal{D})$. The linking condition then implies that $u_k(\mathcal{D})$ intersects P_∞ , contradicting the result of Corollary 3.3.

Suppose now that P is identical to P_∞ or some cover thereof. For any component $K_j \subset K$, observe that $u_k(\dot{\Sigma})$ never intersects K_j . Then repeating the argument above, we find a disk $\mathcal{D} \subset \dot{\Sigma}$ such that for sufficiently large k , $u_k(\partial\mathcal{D})$ is a knot uniformly close to P_∞ . This implies $\text{lk}(P_\infty, K_j) = 0$, another contradiction, thus proving that the plane \tilde{w}_∞ cannot exist.

Case 2: assume $\rho_k \rightarrow 0$. Here we will find that either a plane or a disk bubbles off, depending on how fast ρ_k approaches 0. Choose a sequence $\zeta'_k \in \mathbb{D}$ such that $\zeta_k := \varphi_k(\zeta'_k) \in \partial\Sigma$ and $|\zeta'_k| = \rho_k$. By Remark 3.18, we can find a sequence of holomorphic embeddings

$$\varphi_k^+ : \mathbb{D}^+ \hookrightarrow \dot{\Sigma}$$

that map 0 to ζ_k and $\mathbb{D}^+ \cap \mathbb{R}$ into $\partial\Sigma$, and satisfy the bounds specified in Lemma 3.17. We claim there is a sequence of radii $r_k \rightarrow 0$ such that $z_k \in \varphi_k^+(\mathbb{D}_{r_k}^+)$. Indeed, from Lemma 3.17, we know that $\varphi^+(\mathbb{D}_{r_k}^+)$ contains all points $\zeta \in \dot{\Sigma}$ with $\text{dist}_{h_k}(\zeta, \zeta_k) \leq d_k$, where

$$d_k \geq c_2 r_k \cdot \text{inrad}_k(\zeta_k).$$

We have also the estimates

$$\begin{aligned} \text{dist}_{h_k}(z_k, \zeta_k) &\leq C_2 \rho_k \cdot \text{inrad}_k(z_k), \\ \text{inrad}_k(\zeta_k) &\geq (c_3 - c_4 \rho_k) \cdot \text{inrad}_k(z_k). \end{aligned}$$

Then when ρ_k is sufficiently small we can set

$$r_k = \frac{2C_2}{c_2(c_3 - c_4 \rho_k)} \rho_k$$

and compute,

$$\text{dist}_{h_k}(\zeta_k, z_k) \leq \frac{C_2}{c_3 - c_4 \rho_k} \rho_k \cdot \text{inrad}_k(\zeta_k) = \frac{1}{2} c_2 r_k \text{inrad}_k(\zeta_k) < d_k.$$

We can thus choose a sequence $z'_k \in \mathbb{D}^+$ with $z'_k \rightarrow 0$ and $\varphi_k^+(z'_k) = z_k$. Defining a sequence of \tilde{J}_k -holomorphic half-disks

$$\tilde{v}_k = \tilde{u}_k \circ \varphi^+ : \mathbb{D}^+ \rightarrow \mathbb{R} \times S^3,$$

we have

$$\begin{aligned} R_k := |d\tilde{v}_k(z'_k)| &= |d\tilde{u}_k(z_k)|_k \cdot |d\varphi^+(z'_k)|_k \geq C |d\tilde{u}_k(z_k)|_k \cdot \text{inrad}_k(\zeta_k) \\ &\geq C(c_3 - c_4 \rho_k) |d\tilde{u}_k(z_k)|_k \cdot \text{inrad}_k(z_k) \rightarrow \infty. \end{aligned}$$

Using Lemma 3.8, we may assume there is a sequence of positive numbers $\epsilon_k \rightarrow 0$ such that $\epsilon_k R_k \rightarrow \infty$ and $|d\tilde{v}_k(z)| \leq 2R_k$ for all $z \in \mathbb{D}^+$ with $|z - z'_k| \leq \epsilon_k$. Writing $z'_k = s_k + it_k$, there are two possibilities:

Case 2a: assume $t_k R_k$ is unbounded. Passing to a subsequence, we may assume $t_k R_k \rightarrow \infty$, thus $r'_k := \min\{\epsilon_k R_k, t_k R_k\} \rightarrow \infty$. Then for sufficiently large k we can define embeddings $\psi_k : \mathbb{D}_{r'_k} \hookrightarrow \mathbb{D}^+$ by

$$\psi_k(z) = z_k + \frac{z}{R_k}.$$

Arguing as in case 1, there is now a sequence of rescaled maps

$$\tilde{w}_k = (\beta_k, w_k) = \tilde{v}_k \circ \psi_k : \mathbb{D}_{r'_k} \rightarrow \mathbb{R} \times S^3$$

and constants $c_k \in \mathbb{R}$ such that a subsequence of $(\beta_k + c_k, w_k)$ converges in C_{loc}^∞ to a nonconstant \tilde{J}_∞ -holomorphic finite energy plane $\tilde{w}_\infty = (\beta_\infty, w_\infty) : \mathbb{C} \rightarrow \mathbb{R} \times S^3$, giving the same contradiction as before.

Case 2b: assume $t_k R_k$ is bounded. Now define $\psi_k : \mathbb{D}_{\epsilon_k R_k}^+ \hookrightarrow \mathbb{D}^+$ by

$$\psi_k(z) = s_k + \frac{z}{R_k},$$

and let

$$\tilde{w}_k = (\beta_k, w_k) = \tilde{v}_k \circ \psi_k : \mathbb{D}_{\epsilon_k R_k}^+ \rightarrow \mathbb{R} \times S^3.$$

Then $|d\tilde{w}_k|$ is uniformly bounded. Passing to a subsequence, $(\beta_k - \beta_k(0), w_k)$ converges in C_{loc}^∞ to a \tilde{J}_∞ -holomorphic half-plane

$$\tilde{w}_\infty = (\beta_\infty, w_\infty) : \mathbb{H} \rightarrow \mathbb{R} \times S^3,$$

satisfying $E_\infty(\tilde{w}_\infty) < \infty$ and the boundary condition $\tilde{w}_\infty(\mathbb{R}) \subset \{0\} \times L_j$ for some $j \in \{1, \dots, m\}$. It is not constant, since $|d\tilde{w}_k(it_k R_k)| = \frac{1}{R_k} |d\tilde{v}_k(s_k + it_k)| = 1$ and a subsequence of $it_k R_k$ converges in \mathbb{D}^+ . Now identifying \mathbb{H} conformally with $\mathbb{D} \setminus \{1\}$, we can regard \tilde{w}_∞ as a holomorphic disk with a puncture on the boundary, and Theorem 3.12 tells us that the puncture is removable. Thus extending over the puncture defines a \tilde{J}_∞ -holomorphic disk

$$\tilde{w} = (\beta, w) : \mathbb{D} \rightarrow \mathbb{R} \times S^3$$

with $w(\partial\mathbb{D}) \subset L_j$. By topological considerations, we can severely restrict the homotopy class of the loop $\gamma = w|_{\partial\mathbb{D}} : \partial\mathbb{D} \rightarrow L_j$. Indeed, choose a radius r slightly less than 1 so that $w|_{\partial\mathbb{D}_r} : \partial\mathbb{D}_r \rightarrow S^3$ is uniformly close to γ . Returning to the half-plane \mathbb{H} , there is then a large simply connected region $\Omega \subset \mathbb{H}$ with smooth boundary such that for large k , $w_k|_{\partial\Omega} : \partial\Omega \rightarrow S^3$ is also uniformly close to γ . Undoing the reparametrization one step further, there is then an embedded disk $\mathcal{D} \subset \Sigma$ such that for some large k ,

$$u_k|_{\partial\mathcal{D}} : \partial\mathcal{D} \rightarrow S^3$$

is uniformly close to γ . Since u_k does not intersect either P_∞ or any of the knots $K_j \subset K$, this implies

$$\text{lk}(\gamma, P_\infty) = \text{lk}(\gamma, K_1) = \dots = \text{lk}(\gamma, K_m) = 0.$$

This is only possible if γ is contractible on L_j . But this implies that the Maslov index $\mu(\tilde{w})$ is zero. In this case $\text{ind}(\tilde{w}) = -\chi(\mathbb{D}) + 1 = 0$, and Theorem 2.4 gives

$$0 \leq 2 \text{wind}_\pi(\tilde{w}) \leq \text{ind}(\tilde{w}) - 2 = -2,$$

unless $E_{\omega_\infty}(\tilde{w}) = 0$. The latter is also impossible by Prop 3.11, since \tilde{w} is not constant. \square

Having proved the gradient bound when $m \geq 2$, we now apply similar arguments for $m \leq 1$ and finish the proof of C_{loc}^∞ -convergence for this case.

Proposition 3.20. *The statement about C_{loc}^∞ -convergence in Theorem 3.4 holds if $\chi(\dot{\Sigma}) \geq 0$.*

Proof. This includes two cases: $\dot{\Sigma}$ is diffeomorphic to either a plane or a singly punctured disk. In both cases the space of conformal structures on the domain is trivial, so we can assume $(\dot{\Sigma}, j_k)$ is either (\mathbb{C}, i) or $(\mathbb{C} \setminus \mathcal{D}, i)$ for all k , where $\mathcal{D} = \text{int } \mathbb{D}$. We then have a sequence of maps $\tilde{u}_k = (a_k, u_k) : \dot{\Sigma} \rightarrow \mathbb{R} \times S^3$ satisfying $T\tilde{u}_k \circ i = \tilde{J}_k \circ T\tilde{u}$, all positively asymptotic at $\infty \in \Sigma$ to the simply covered orbit P_∞ .

We address first the case $\dot{\Sigma} = \mathbb{C}$; then there is no boundary condition and $M = S^3$. By the same rescaling argument as in Prop. 3.19, we may assume after reparametrization that $|d\tilde{u}_k(z)|$ satisfies a global uniform bound and that $|d\tilde{u}_k(0)|$ is bounded away from zero. Then a subsequence of $(a_k - a_k(0), u_k)$ converges in C_{loc}^∞ to a nonconstant \tilde{J}_∞ -holomorphic finite energy plane $\tilde{u}_\infty = (a_\infty, u_\infty) : \mathbb{C} \rightarrow \mathbb{R} \times S^3$. If the puncture is removable, then just as in Prop. 3.19, \tilde{u}_∞ extends to a nonconstant sphere of index -2 , which violates Theorem 2.4. Thus \tilde{u}_∞ is positively asymptotic to a periodic orbit P , which we claim must be P_∞ . Indeed, if P and P_∞ are geometrically distinct, then the same linking argument implies $\text{lk}(P, P_\infty) = 0$, a contradiction. Suppose now that P is an n -fold cover of P_∞ for some integer $n \geq 1$. Writing $\omega_k = d\alpha_k$ by Lemma 3.13 and fixing any smooth map $u : \mathbb{C} \rightarrow S^3$ that approaches P_∞ asymptotically,

$$E_{\omega_k}(\tilde{u}_k) = \int_{\mathbb{C}} u^* \omega_k = \int_{P_\infty} \alpha_k \rightarrow E_\infty := \int_{\mathbb{C}} u^* \omega_\infty = \int_{P_\infty} \alpha_\infty.$$

But then

$$nE_\infty = \int_P \alpha_\infty = \int_{\mathbb{C}} u_\infty^* \omega_\infty \leq \lim \int_{\mathbb{C}} u_k^* \omega_k = E_\infty.$$

The left hand side equals $E_\infty(\tilde{u}_\infty)$ and must therefore be positive, so we conclude $n = 1$.

Next suppose $\dot{\Sigma} = \mathbb{C} \setminus \mathcal{D}$. We claim that $|d\tilde{u}_k|$ is uniformly bounded. If not, then as in Prop. 3.19, we can define rescaled maps \tilde{v}_k on an increasing sequence of either disks or half-disks, depending on whether and how fast z_k approaches the boundary. These then have a subsequence convergent to a non-constant finite energy plane or half-plane \tilde{v}_∞ . The usual arguments show that if \tilde{v}_∞ is a plane, it cannot be extended to a sphere, and the

linking conditions on its asymptotic orbit force it to intersect either P_∞ or K , neither of which is allowed. For the half-plane case, \tilde{v} extends to a non-constant pseudoholomorphic disk, and the same argument as before shows that $\tilde{v}(\partial\mathbb{D})$ is contractible on L , thus its Maslov index is 0, and it must therefore have vanishing ω_∞ -energy, another contradiction.

Given the uniform bound, there are constants $c_k \in \mathbb{R}$ and a subsequence of $(a_k + c_k, u_k)$ which converges in C_{loc}^∞ to a \tilde{J}_∞ -holomorphic finite energy map $\tilde{u}_\infty : \dot{\Sigma} \rightarrow \mathbb{R} \times M$, with the boundary condition $\tilde{u}_\infty(\partial\Sigma) \subset \{0\} \times L$. Then it remains to prove that \tilde{u}_∞ has a positive puncture at ∞ , asymptotic to P_∞ with covering number 1. If the puncture is removable, we obtain a holomorphic disk

$$\mathbb{D} \rightarrow \mathbb{R} \times S^3 : z \mapsto \tilde{u}_\infty(1/z)$$

mapping $\partial\mathbb{D}$ to a meridian on L , thus u_∞ must intersect K . But then u_k for large k would have to intersect the interior of N , giving a contradiction. Now suppose \tilde{u}_∞ is asymptotic to a periodic orbit P at ∞ . If we extend \tilde{u}_∞ to a smooth map over \mathbb{C} , taking \mathcal{D} into the solid torus N , then the same argument as in the plane case shows that P cannot be geometrically distinct from P_∞ . Therefore P is an n -fold cover of P_∞ with $n \neq 0$. (Here we adopt the convention of setting n to *negative* the covering number if the puncture is negative; this possibility is not excluded automatically when $\partial\Sigma \neq \emptyset$.) Now observe $u_k(\dot{\Sigma}) \cap K = \emptyset$ for all k , so if k is sufficiently large, a small perturbation of u_k realizes a homology $\partial[u_k] = n[P_\infty] + [\gamma]$ in $S^3 \setminus K$, where γ is a negatively oriented meridian on L . Consequently

$$n \cdot \text{lk}(P_\infty, K) = -\text{lk}(\gamma, K) = 1,$$

and since $\text{lk}(P_\infty, K) > 0$ by assumption, n can only be 1. \square

3.6. Convergence of conformal structures. We now show that in the case $\chi(\dot{\Sigma}) < 0$, the induced sequence of conformal structures is compact.

Proposition 3.21. *Given the hypotheses of Theorem 3.4, there is a smooth complex structure j_∞ on Σ and a sequence of diffeomorphisms $\varphi_k : \Sigma \rightarrow \Sigma$ fixing ∞ and preserving each component of $\partial\Sigma$, such that a subsequence of $\varphi_k^* j_k$ converges to j_∞ in the C^∞ -topology.*

There are also constants $c_k \in \mathbb{R}$ such that a subsequence of $(a_k + c_k, u_k) \circ \varphi_k$ converges in $C_{\text{loc}}^\infty(\dot{\Sigma}, \mathbb{R} \times M)$ to a map $\tilde{u}_\infty \in \mathcal{M}_{\mathcal{H}_\infty, \Lambda}$, which is positively asymptotic to P_∞ at the puncture.

Proof. A subsequence of $(\Sigma, j_k, \{\infty\})$ converges to a stable nodal surface $\mathbf{S} = (S, j, \{p\}, \Delta, N)$. A choice of decoration r defines the compact connected surface $\overline{\mathbf{S}}_r$, with a singular conformal structure $j_{\mathbf{S}}$ and singular Poincaré metric $h_{\mathbf{S}}$, both of which degenerate on a finite set of circles and arcs $\Theta_{\Delta, N} \subset \overline{\mathbf{S}}_r$. Then convergence means there is a sequence of diffeomorphisms

$$\varphi_k : \overline{\mathbf{S}}_r \rightarrow \Sigma$$

such that:

- (1) $\varphi_k(p) = \infty$.
- (2) $\varphi_k^* j_k \rightarrow j_{\mathbf{s}}$ in $C_{\text{loc}}^\infty(\overline{\mathbf{S}}_r \setminus \Theta_{\Delta, N})$.
- (3) All circles in $\varphi_k(\Theta_{\Delta, N})$ are closed geodesics in $(\dot{\Sigma}, h_k)$, and all arcs in $\varphi_k(\Theta_{\Delta, N})$ are geodesic arcs in $(\dot{\Sigma}, h_k)$ that intersect $\partial\Sigma$ transversely.

We can assume without loss of generality that the diffeomorphisms φ_k map a given component of $\partial(\overline{\mathbf{S}}_r)$ always to the *same* component of $\partial\Sigma$, i.e. $\varphi_k \circ \varphi_j^{-1}$ always maps each connected component $\gamma_j \subset \partial\Sigma$ to itself.

If S_j is a connected component of S , let \dot{S}_j be the punctured surface obtained by removing all points in the set $(\{p\} \cup \Delta \cup N) \cap S_j$. Note that the stability condition implies $\chi(\dot{S}_j^D) < 0$. There is a natural embedding $\dot{S}_j \hookrightarrow \overline{\mathbf{S}}_r \setminus \Theta_{\Delta, N}$, which we use to define the sequence of complex structures $\varphi_k^* j_k$ and metrics $\varphi_k^* h_k$ on \dot{S}_j . Then passing to a subsequence, we have $\varphi_k^* j_k \rightarrow j$ and $\varphi_k^* h_k \rightarrow h$ in C_{loc}^∞ on \dot{S}_j , where h is the Poincaré metric for (\dot{S}_j, j) . Since $d\tilde{u}_k$ is uniformly bounded on compact subsets, we can then find constants $c_k^j \in \mathbb{R}$ such that

$$\tilde{v}_k^j = (b_k^j, v_k^j) = (a_k + c_k^j, u_k) \circ \varphi_k|_{\dot{S}_j} : (\dot{S}_j, \varphi_k^* j_k) \rightarrow (\mathbb{R} \times S^3, \tilde{J}_k)$$

is a sequence of pseudoholomorphic maps satisfying the appropriate boundary conditions and a uniform C^1 -bound. Thus \tilde{v}_k^j has a C_{loc}^∞ -convergent subsequence

$$\tilde{v}_k^j \rightarrow \tilde{v}^j = (b^j, v^j) : \dot{S}_j \rightarrow \mathbb{R} \times S^3,$$

where \tilde{v}^j satisfies $T\tilde{v}^j \circ j = \tilde{J}_\infty \circ T\tilde{v}^j$. Due to the uniform energy bound for \tilde{u}_k , we see also that $E_\infty(\tilde{v}^j) < \infty$. Repeating this process for every component $S_j \subset S$, we obtain a set of \tilde{J}_∞ -holomorphic maps

$$\begin{aligned} \tilde{v}^1 : \dot{S}_1 &\rightarrow \mathbb{R} \times S^3, \\ &\vdots \\ \tilde{v}^N : \dot{S}_N &\rightarrow \mathbb{R} \times S^3. \end{aligned}$$

Our main goal now is to show that \mathbf{S} is actually a smooth Riemann surface with boundary, i.e. Δ and N are empty sets and S has only one component. Then the set of solutions above reduces to a single solution $\tilde{u}_\infty : \dot{\Sigma} \rightarrow \mathbb{R} \times M$, which we must show is positively asymptotic to P_∞ at the puncture. As with the bubbling off arguments in the previous section, these results will follow mainly from topological considerations.

Recall from Remark 3.1 that our notation allows some of the components K_i and K_j of K to be identical; in particular, topological considerations require a given component $K_i \subset K$ to repeat n times in the list K_1, \dots, K_m if $\text{lk}(K_i, P_\infty) = n$. The lists of components $N = N_1 \cup \dots \cup N_m$ and $L = L_1 \cup \dots \cup L_m$ are then defined with similar repetitions. If $\gamma_1, \dots, \gamma_m$ are the connected components of $\partial\Sigma$ (*not* repeated), then the oriented loop $u_k(\gamma_j)$ is a meridian on $L_j = \partial N_j$ with $\text{lk}(u_k(\gamma_j), K_j) = -1$. Thus the linking number $\text{lk}(K_j, P_\infty)$ is precisely the number of distinct components

of $\partial\Sigma$ mapped into the same torus L_j , and we have also $\text{lk}(u_k(\gamma_j), K) = -1$ since $u_k(\gamma_j)$ is unlinked with all components of K that are distinct from K_j . Adding this up for all $\gamma_j \subset \partial\Sigma$, we see that the expression

$$- \text{lk}(u_k(\partial\Sigma), K)$$

counts the connected components of $\partial\Sigma$. Also, the map u_k realizes a homology $\partial[u_k] = [P_\infty] + [u_k(\partial\Sigma)]$ in $S^3 \setminus K$, which gives the useful formula

$$(3.6) \quad \text{lk}(K_j, P_\infty) = - \text{lk}(K_j, u_k(\partial\Sigma)).$$

In light of this topological setup, u_k extends to a smooth map

$$\bar{u}_k : \mathbb{C} \rightarrow \mathbb{R} \times S^3$$

which satisfies $T\bar{u}_k \circ j_k = \tilde{J}_k \circ T\bar{u}_k$ in $\dot{\Sigma} = \mathbb{C} \setminus (\mathcal{D}_1 \cup \dots \cup \mathcal{D}_m) \subset \mathbb{C}$, and maps each of the disks \mathcal{D}_j into N_j . We may assume that $\bar{u}_k|_{\mathcal{D}_j}$ has a single transverse positive intersection with K_j .

Let $S_1 \subset S$ be the connected component that contains the marked point p .

Claim: \tilde{v}^1 is positively asymptotic to P_∞ at p . If the puncture is removable, then we can find an oriented circle $C \subset \dot{S}_1$ winding clockwise around p such that $v^1(C)$ lies in an arbitrarily small neighborhood of some point in $S^3 \setminus K$. Then this neighborhood also contains $v_k^1(C) = u_k(\varphi_k(C))$ for sufficiently large k , and $\varphi_k(C)$ is a large circle in \mathbb{C} , bounding a simply connected region Ω . One can then define a smooth map

$$\hat{u}_k : \mathbb{C} \rightarrow S^3 \setminus K,$$

which matches u_k outside of Ω , so that the loops $\hat{u}_k(\partial\mathbb{D}_R)$ approach P_∞ as $R \rightarrow \infty$. This implies that for any component $K_j \subset K$, $\text{lk}(P_\infty, K_j) = 0$, a contradiction.

If p is a nonremovable puncture and \tilde{v}^1 is asymptotic to an orbit P that is geometrically distinct from P_∞ , we similarly find a large clockwise oriented circle $\varphi_k(C) \subset \mathbb{C}$, bounding a region Ω , such that $u_k(\varphi_k(C))$ is close to P . Then the existence of the map $\bar{u}_k|_\Omega : \Omega \rightarrow S^3 \setminus P_\infty$ implies $\text{lk}(P, P_\infty) = 0$, and this is impossible. The alternative is that P could be an n -fold cover of P_∞ for some integer $n \neq 0$. (Negative n would again mean the puncture is negative.) But then restricting u_k to the region outside of Ω gives a homotopy of $u_k(\varphi_k(C))$ to P_∞ in $S^3 \setminus K$, implying that for any component $K_j \subset K$,

$$n \cdot \text{lk}(P_\infty, K_j) = \text{lk}(u_k \circ \varphi_k(C), K_j) = \text{lk}(P_\infty, K_j),$$

so $n = 1$. This proves the claim.

With the asymptotic behavior at p understood, it remains to prove that \mathbf{S} has no double points or unpaired nodes. Note that it suffices to prove this for the component $S_1 \subset S$. We shall set up the discussion in a slightly more general way than is immediately necessary, since it will also be useful for the degeneration argument in the next section.

First some notation. The m connected components of $\partial\Sigma$ are denoted

$$\partial\Sigma = \gamma_1 \cup \dots \cup \gamma_m,$$

and let us write the components of ∂S_1 as

$$\partial S_1 = \alpha_1 \cup \dots \cup \alpha_s.$$

Note that $m \geq 2$ by assumption, but ∂S_1 could conceivably be empty. Assume S_1 has a (possibly empty) set of unpaired nodes

$$N \cap S_1 = \{w_1, \dots, w_\ell\},$$

interior double points

$$\Delta \cap \text{int } S_1 = \{z_1, \dots, z_q\},$$

and boundary double points

$$\Delta \cap \partial S_1 \supset \Delta \cap \alpha_j = \{\zeta_j^1, \dots, \zeta_j^{r_j}\} \quad \text{for } j = 1, \dots, s,$$

where we are regarding Δ for the moment as a set of *points* in S rather than pairs of points. We know from Theorem 3.12 that \tilde{v}^1 extends smoothly over each boundary double point $\zeta_j^i \in \Delta \cap \partial S_1$, and at each $z_j \in \Delta \cap \text{int } S_1$ and $w_j \in N \cap S_1$, \tilde{v}_1 either has a removable singularity or is asymptotic to some periodic orbit of X_∞ .

Let \bar{S}_1 denote the compact surface with piecewise smooth boundary obtained from $S_1 \setminus ((\Delta \cup N) \cap S_1)$ by replacing the interior punctures z_j, w_j with circles at infinity $\delta_{z_j}, \delta_{w_j}$ and the boundary punctures ζ_j^i with arcs at infinity $\delta_{\zeta_j^i}$. Each component $\alpha_j \subset \partial S_1$ then gives rise to a piecewise smooth circular component $\bar{\alpha}_j \subset \partial \bar{S}_1$. There is a natural map $\bar{S}_1 \rightarrow \bar{\mathbf{S}}_r$, which is an inclusion except possibly on $\partial \bar{S}_1$, where two distinct circles δ_{z_j} or arcs $\delta_{\zeta_j^i}$ may have the same image; this corresponds to the identification of double points in a pair. Since $\bar{\mathbf{S}}_r$ is diffeomorphic to

$$\Sigma = \mathbb{C} \cup \{\infty\} \setminus (\mathcal{D}_1 \cup \dots \cup \mathcal{D}_m),$$

we can visualize $\bar{\mathbf{S}}_r \setminus \{p\}$ as the plane with a finite set of disks removed. An example of this is shown in Figure 6. Here we settle on the convention that the circles δ_{z_j} are always oriented as components of ∂S_1 . Thus they appear as embedded loops winding *clockwise* in the plane, and each encloses a bounded region which may contain some of the disks \mathcal{D}_i . Let m_j be the number of such disks enclosed by δ_{z_j} . Similarly, for $j = 1, \dots, s$, denote by \hat{m}_j the number of disks in the compact region enclosed by $\bar{\alpha}_j$; this number is always at least 1. Figure 6 shows a compact subset of $\bar{\mathbf{S}}_r$ which contains the entire boundary of \bar{S}_1 . Here the closure of the white area is \bar{S}_1 , and the lightly shaded regions constitute the rest of $\bar{\mathbf{S}}_r$, while the darkly shaded regions are the disks \mathcal{D}_j .

The integers defined above are related by

$$(3.7) \quad m = \ell + \sum_{j=1}^q m_j + \sum_{j=1}^s \hat{m}_j,$$

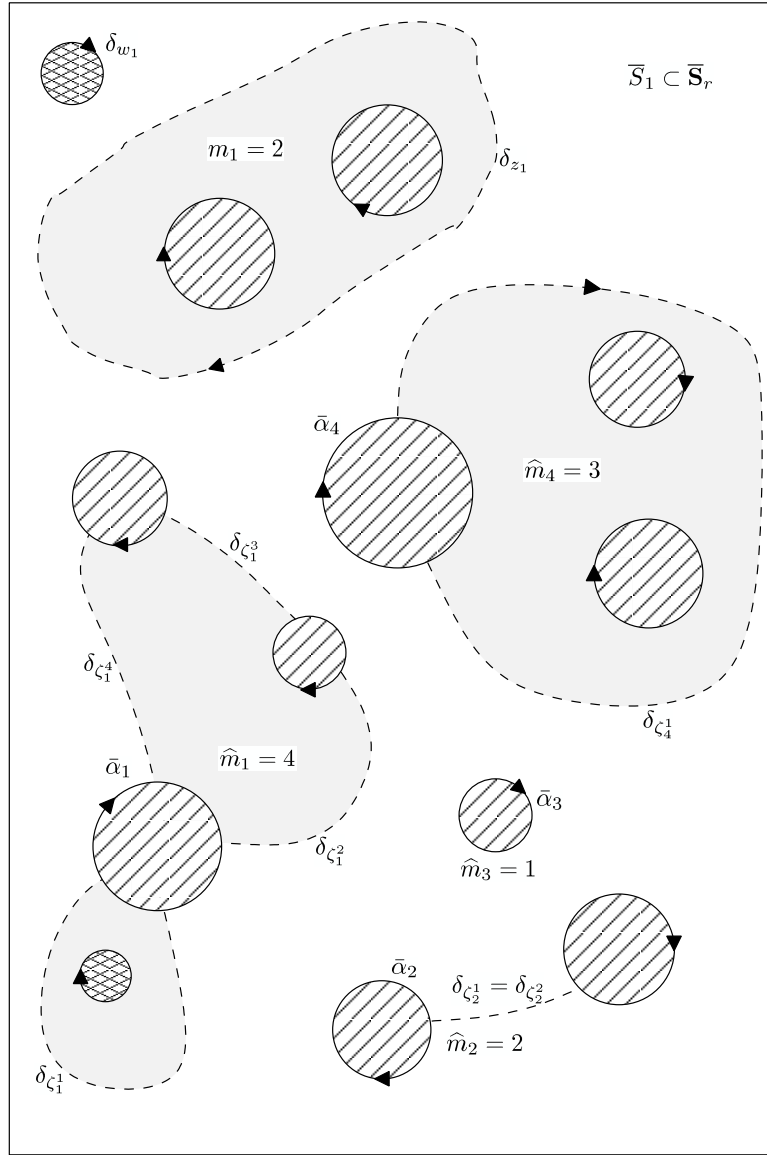

FIGURE 6. A compact subset of \bar{S}_r showing the piecewise smooth boundary of $\partial\bar{S}_1$. Here we assume ∂S_1 has four components $\alpha_1, \dots, \alpha_4$, S_1 has one interior double point $\Delta \cap \text{int } S_1 = \{z_1\}$, seven boundary double points $\Delta \cap \alpha_1 = \{\zeta_1^1, \dots, \zeta_1^4\}$, $\Delta \cap \alpha_2 = \{\zeta_2^1, \zeta_2^2\}$, $\Delta \cap \alpha_3 = \emptyset$, $\Delta \cap \alpha_4 = \{\zeta_4^1\}$, and one unpaired node $N \cap S_1 = \{w_1\}$.

and as remarked already,

$$(3.8) \quad \hat{m}_j \geq 1 \quad \text{for all } j = 1, \dots, s.$$

There are also constraints imposed by the stability condition for each component of S : the double of \hat{S}_1 must have negative Euler characteristic,

thus

$$(3.9) \quad 2(s + q + \ell) + \sum_{j=1}^s r_j > 2,$$

and applying similar reasoning to the portions of $\overline{\mathbf{S}}_r$ inside the loops δ_{z_j} , we have

$$(3.10) \quad m_j \geq 2 \quad \text{for all } j = 1, \dots, q.$$

We now transfer this picture onto $\dot{\Sigma}$ via the diffeomorphism

$$\varphi_k : \overline{\mathbf{S}}_r \setminus \{p\} \rightarrow \dot{\Sigma}$$

for large k (see Figure 7). For $j = 1, \dots, q$, denote by $\partial_j \Sigma$ the m_j components of $\partial \Sigma$ that are enclosed within $\varphi_k(\delta_{z_j})$, and for $j = 1, \dots, s$ let $\hat{\partial}_j \Sigma$ be the \hat{m}_j components in the closed region bounded by $\varphi_k(\bar{\alpha}_j)$. Now for each component $\alpha_j \subset \partial S_1$, we define a perturbed loop $\alpha'_j \subset \text{int } S_1$ which misses the double points. The images $\varphi_k(\alpha'_j) \subset \dot{\Sigma}$ are represented as dotted loops in Figure 7; each encloses a bounded region that contains $\hat{\partial}_j \Sigma$. Similarly, for each interior double point z_j we choose a perturbed loop $C_j \subset \text{int } \overline{S}_1$ near δ_{z_j} , so $\varphi_k(C_j)$ encloses $\partial_j \Sigma$. Define also the loops $\beta_j \subset \text{int } \overline{S}_1$ as perturbations of δ_{w_j} for unpaired nodes $w_j \in N \cap S_1$: thus each $\varphi_k(\beta_j)$ encloses a unique connected component $\gamma_{g(j)} \subset \partial \Sigma$. Observe that $\partial \Sigma$ is now the disjoint union

$$\partial \Sigma = \left(\bigcup_{j=1}^q \partial_j \Sigma \right) \cup \left(\bigcup_{j=1}^s \hat{\partial}_j \Sigma \right) \cup \left(\bigcup_{j=1}^{\ell} \gamma_{g(j)} \right).$$

The images under φ_k of the various perturbed loops are shown with dotted lines in Figure 7.

From this picture we can deduce some topological facts about the behavior of $v^1 : \dot{S}_1 \rightarrow S^3$ at its boundary and punctures. For a component $\alpha_j \subset \partial S_1$, we have $v^1(\alpha_j) \subset L_{f(j)}$ for some $f(j) \in \{1, \dots, m\}$, and we can assume $u_k \circ \varphi_k(\alpha'_j)$ is C^0 -close to $v^1(\alpha_j)$. Then restricting u_k to the bounded region inside $\varphi_k(\alpha'_j)$ realizes a homology

$$\partial[u_k] = -[u_k \circ \varphi_k(\alpha'_j)] + [u_k(\hat{\partial}_j \Sigma)]$$

in both $S^3 \setminus P_\infty$ and $S^3 \setminus K$. This implies

$$\text{lk}(u_k \circ \varphi_k(\alpha'_j), P_\infty) = \text{lk}(u_k(\hat{\partial}_j \Sigma), P_\infty) = 0,$$

and thus

$$(3.11) \quad \text{lk}(v^1(\alpha_j), P_\infty) = 0.$$

This means $v^1(\alpha_j)$ covers a meridian on $L_{f(j)}$, and its homotopy class can be deduced exactly via the linking number with K :

$$\text{lk}(v^1(\alpha_j), K) = \text{lk}(u_k \circ \varphi_k(\alpha'_j), K) = \text{lk}(u_k(\hat{\partial}_j \Sigma), K) = -\hat{m}_j.$$

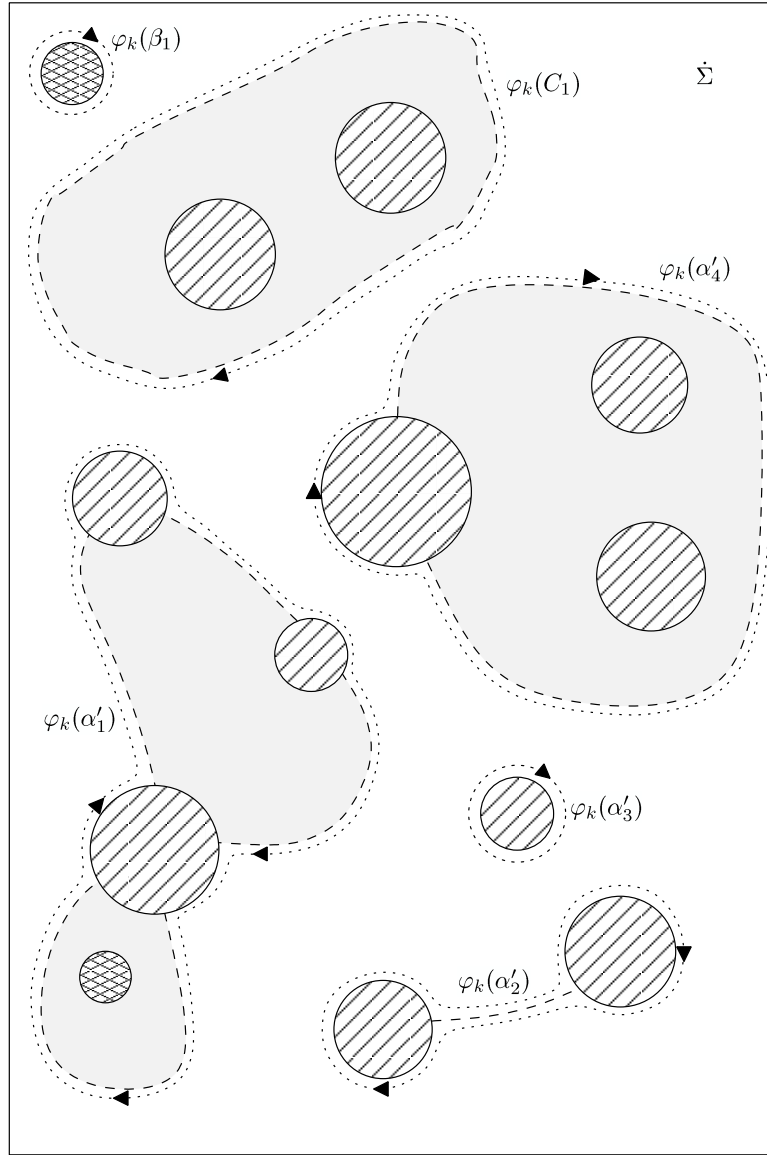

FIGURE 7. The image of Figure 6 under $\varphi_k : \overline{S}_r \setminus \{p\} \rightarrow \hat{\Sigma}$, showing the perturbed loops $\alpha'_1, \dots, \alpha'_4, \beta_1$ and C_1 as dotted lines.

Since $v^1(\alpha_j)$ is only linked with one component of K ,

$$(3.12) \quad \text{lk}(v^1(\alpha_j), K_{f(j)}) = -\widehat{m}_j.$$

Turning our attention next to the unpaired nodes, let us assume there is a simply covered orbit $P_j \subset S^3$ of X_∞ such that \tilde{v}^1 is asymptotic to an $|n_j|$ -fold cover of P_j at $w_j \in N \cap S_1$, for some $n_j \in \mathbb{Z}$. Again, we're using the convention that the sign of n_j matches the sign of the puncture at w_j , and we set $n_j = 0$ if the puncture is removable (in which case it doesn't

matter what P_j is). Now, restricting u_k to the region between $\gamma_{g(j)}$ and $\varphi_k(\beta_j)$, we have a homology

$$\partial[u_k] = [u_k(\gamma_{g(j)})] - [u_k \circ \varphi_k(\beta_j)],$$

in both $S^3 \setminus P_\infty$ and $S^3 \setminus K$, and we can assume $[u_k \circ \varphi_k(\beta_j)]$ is homologous to $n_j[P_j]$. Thus for every component $K_i \subset K$,

$$(3.13) \quad n_j \operatorname{lk}(P_j, K_i) = \operatorname{lk}(u_k(\gamma_{g(j)}), K_i).$$

Adding these up for all components of K , we find

$$n_j \operatorname{lk}(P_j, K) = -1,$$

implying that the puncture is nonremovable and the orbit is simply covered. If $P_j = P_\infty$ this gives $n_j m = -1$, which cannot be true since $m \geq 2$ by assumption. Thus P_j is geometrically distinct from P_∞ , and using the homology in $S^3 \setminus P_\infty$, we have $n_j \operatorname{lk}(P_j, P_\infty) = \operatorname{lk}(u_k(\gamma_{g(j)}), P_\infty) = 0$, implying

$$(3.14) \quad \operatorname{lk}(P_j, P_\infty) = 0.$$

We can reach similar conclusions about the behavior of \tilde{v}^1 at an interior double point $z_j \in \Delta \cap \operatorname{int} S_1$. Using the same convention as above, assume v^1 approaches an $|n'_j|$ -fold cover of some simply covered orbit P'_j at z_j . Then we may assume $[u_k \circ \varphi_k(C_j)]$ is homologous to $n'_j[P'_j]$, and by restricting u_k over the bounded region inside $\varphi_k(C_j)$,

$$\partial[u_k] = [u_k(\partial_j \Sigma)] - [u_k \circ \varphi_k(C_j)]$$

in both $S^3 \setminus K$ and $S^3 \setminus P_\infty$. This implies for all components $K_i \subset K$,

$$(3.15) \quad n'_j \operatorname{lk}(P'_j, K_i) = \operatorname{lk}(u_k(\partial_j \Sigma), K_i),$$

and summing this over the components of K , we have

$$n'_j \operatorname{lk}(P'_j, K) = -m_j \leq -2,$$

so n'_j cannot be zero, i.e. the puncture is not removable. If $P'_j = P_\infty$, we have $n'_j m = -m_j$, then $m_j \leq m$ implies $n'_j = -1$ and $m = m_j$. But this contradicts the stability assumption; indeed, combining (3.8), (3.10) and (3.7), we find $q = 1$ and $s = \ell = 0$, violating (3.9). Therefore P'_j is geometrically distinct from P_∞ , and the homology in $S^3 \setminus P_\infty$ gives $n'_j \operatorname{lk}(P'_j, P_\infty) = \operatorname{lk}(u_k(\partial_j \Sigma), P_\infty) = 0$, thus

$$(3.16) \quad \operatorname{lk}(P'_j, P_\infty) = 0.$$

At this point all the vital ingredients are in place.

Claim: $N \cap S_1$ and $\Delta \cap S_1$ are empty. If $w_j \in N \cap S_1$, then v^1 is asymptotic to a periodic orbit P_j which is geometrically distinct from P_∞ , and is also unlinked with it, by (3.14). But we have assumed there is no such orbit, therefore $N \cap S_1 = \emptyset$. The same argument proves $\Delta \cap \operatorname{int} S_1 = \emptyset$, using (3.16).

It remains only to exclude double points on the boundary. We now can assume that $\partial S_1 \neq \emptyset$ and the only puncture of \tilde{v}^1 is at p , where it

is positively asymptotic to P_∞ . By assumption, there is a trivialization Φ_∞ of $(v^1)^*\xi_\infty|_M$ for which $\mu_{CZ}^{\Phi_\infty}(P_\infty) = 3$ and, using (3.12) and the fact that $v^1(\alpha_j)$ covers a meridian for each component $\alpha_j \subset \partial S_1$, the Maslov index along α_j is $2\text{lk}(v^1(\alpha_j), K_{f(j)}) = -2\widehat{m}_j$. Thus we compute $\mu(\tilde{v}^1) = 3 - 2\sum_{j=1}^s \widehat{m}_j$, and

$$\begin{aligned} \text{ind}(\tilde{v}^1) &= \mu(\tilde{v}^1) - \chi(\dot{S}_1) + s \\ &= 3 - 2\sum_{j=1}^s \widehat{m}_j - (1 - s) + s = 2 + 2\sum_{j=1}^s (1 - \widehat{m}_j). \end{aligned}$$

The ω_∞ -energy of \tilde{v}^1 is clearly nonzero since $v^1(\partial S_1)$ and the image of v^1 near p cannot belong to the same orbit. Thus Theorem 2.4 gives

$$0 \leq 2\text{wind}_\pi(\tilde{v}^1) \leq 2\sum_{j=1}^s (1 - \widehat{m}_j).$$

Since $\widehat{m}_j \geq 1$ for all j , the right hand side of this expression is never positive, and is zero if and only if $\widehat{m}_j = 1$ for all j . This excludes situations such as $\bar{\alpha}_1$ and $\bar{\alpha}_2$ in Figure 6, where double points give rise to arcs that connect two distinct disks. All the arcs in $\delta_{\zeta_j^i} \subset \partial \bar{S}_1$ must therefore begin and end on the same circle, enclosing a region of the plane as with $\bar{\alpha}_4$ in the figure. But now the stability condition requires this enclosed region to have negative Euler characteristic after doubling, which can only be true if it contains at least one disk, contradicting the fact that $\widehat{m}_j = 1$. We conclude that there are no such arcs $\delta_{\zeta_j^i}$, and hence no double points $\zeta_j^i \in \Delta \cap \partial S_1$.

It follows now that \mathbf{S} has no double points or unpaired nodes at all, thus the convergence $(\Sigma, j_k, \{\infty\}) \rightarrow (S, j, \{p\}, \Delta, N)$ simply means there are diffeomorphisms $\varphi_k : S \rightarrow \Sigma$ such that $\varphi_k(p) = \infty$ and $\varphi_k^* j_k \rightarrow j$ in $C^\infty(S)$. Then after \mathbb{R} -translation, $\tilde{u}_k \circ \varphi_k \rightarrow \tilde{v}^1$ in $C_{\text{loc}}^\infty(S \setminus \{p\}, \mathbb{R} \times S^3)$, and \tilde{v}^1 has the same asymptotic limit as \tilde{u}_k . This completes the proof of Prop. 3.21. \square

3.7. Degeneration at the boundary. The proof of C_{loc}^∞ -convergence in Theorem 3.5 uses many of the same arguments as Theorem 3.4, so we will not repeat these in any detail, but rather emphasize the aspects that change when the new orbits appear at ∂M in the limit. As before, it's convenient to treat the stable and non-stable cases separately.

The non-stable case. The assumptions of Theorem 3.5 require that $\partial \Sigma$ be nonempty, so the only non-stable case to consider is $m = 1$: then K is a knot with $\text{lk}(P_\infty, K) = 1$, and we may assume $(\dot{\Sigma}, j_k) = (\mathbb{C} \setminus \mathcal{D}, i)$ where $\mathcal{D} = \text{int } \mathbb{D}$. It will be convenient to use the biholomorphic map

$$\psi : \mathbb{R} \times S^1 \rightarrow \mathbb{C} \setminus \{0\} : (s, t) \mapsto e^{2\pi(s+it)}$$

and consider the sequence of \tilde{J}_k -holomorphic half-cylinders

$$\tilde{v}_k = (b_k, v_k) = \tilde{u}_k \circ \psi : [0, \infty) \times S^1 \rightarrow \mathbb{R} \times S^3,$$

with $v_k(\{s\} \times S^1) \rightarrow P_\infty$ as $s \rightarrow \infty$. We claim $|d\tilde{v}_k|$ is uniformly bounded. The proof is almost identical to what was done in Prop. 3.20: a sequence z_k with $|d\tilde{v}_k(z_k)| \rightarrow \infty$ gives rise to a non-constant finite energy plane or disk. A disk is impossible for the same reasons as before: its boundary would have to be contractible on L , leading to the conclusion that the map is constant. A plane cannot be asymptotic to any cover of P_∞ or any orbit that is linked with it. The only new feature is that *a priori* the plane could be asymptotic to one of the orbits on L , but this would imply that v_k intersects K for large k , and is thus also excluded.

Pick an open neighborhood \mathcal{U} of P_∞ in M , small enough so that its closure does not intersect L . Then define

$$s_k = \min\{s \in [0, \infty) \mid v_k((s, \infty) \times S^1) \subset \mathcal{U}\}.$$

Claim: $s_k \rightarrow \infty$. If not, there is a subsequence for which $s_k \rightarrow s_\infty \in [0, \infty)$ and (in light of the gradient bound), there are real numbers c_k such that $(b_k + c_k, v_k)$ is C_{loc}^∞ -convergent to a \tilde{J}_∞ -holomorphic half-cylinder

$$\tilde{v} = (b, v) : [0, \infty) \times S^1 \rightarrow \mathbb{R} \times S^3$$

with finite energy. Observe that $v(\{0\} \times S^1)$ is a meridian on L . Then if the puncture of \tilde{v} is removable, v extends to a disk which must intersect K , implying that some part of the image of v_k lies inside the solid torus N for sufficiently large k , a contradiction.

Since ∞ is not a removable puncture, denote by P its asymptotic orbit. Now the usual linking arguments imply

$$\text{lk}(P, K) = \text{lk}(P_\infty, K) = 1,$$

and if P and P_∞ are geometrically distinct,

$$\text{lk}(P, P_\infty) = 0.$$

This leaves only two possibilities: P is P_∞ (positive puncture, simply covered) or it is a simply covered orbit on L (negative puncture). In the latter case, the fact that ω_∞ is exact and vanishes on L implies $E_{\omega_\infty}(\tilde{v}) = 0$, thus the image of v is contained in a periodic orbit, and therefore in L . But this gives a contradiction, because $v(\{s_\infty\} \times S^1)$ is in the closure of \mathcal{U} , which is disjoint from L .

There remains the possibility that \tilde{v} is positively asymptotic to P_∞ . But then \tilde{v} has precisely the same asymptotic and boundary conditions as \tilde{v}_k , hence $\text{ind}(\tilde{v}) = 2$ and Theorem 2.4 gives $\text{wind}_\pi(\tilde{v}) = 0$. This implies v is transverse to X_∞ , which is impossible at $\{0\} \times S^1$ because both the image of v and the orbits of X_∞ on L are meridians. This contradiction proves the claim that $s_k \rightarrow \infty$.

With this established, define a sequence

$$\tilde{w}_k = (\beta_k, w_k) : [-s_k, \infty) \times S^1 \rightarrow \mathbb{R} \times S^3$$

by $\tilde{w}_k(s, t) = \tilde{v}_k(s + s_k, t)$. Then a subsequence of $(\beta_k + c_k, w_k)$ converges in $C_{\text{loc}}^\infty(\mathbb{R} \times S^1, \mathbb{R} \times S^3)$ to a \tilde{J}_∞ -holomorphic finite energy cylinder

$$\tilde{w}_\infty = (\beta_\infty, w_\infty) : \mathbb{R} \times S^1 \rightarrow \mathbb{R} \times S^3.$$

The loop $\gamma := w_\infty(\{0\} \times S^1)$ is now the uniform limit of $v_k(\{s_k\} \times S^1)$, and the usual arguments show that

$$\text{lk}(\gamma, P_\infty) = 0 \quad \text{and} \quad \text{lk}(\gamma, K) = 1,$$

thus \tilde{w}_∞ cannot be a constant map. If $E_{\omega_\infty}(\tilde{w}_\infty) = 0$, then these linking conditions and the fact that γ is in the closure of \mathcal{U} imply that \tilde{w}_∞ parametrizes $\mathbb{R} \times P_\infty$. However, there exists a sequence (s'_k, t'_k) with $s'_k < s_k$ and $s_k - s'_k \rightarrow 0$ such that $v_k(s'_k, t'_k) \notin \mathcal{U}$, implying that γ also meets the boundary of \mathcal{U} , a contradiction. Therefore $E_{\omega_\infty}(\tilde{w}_\infty) > 0$.

We shall now show that both punctures of \tilde{w}_∞ are positive and asymptotic to the appropriate orbits. If both are removable, we obtain a nonconstant holomorphic sphere of index -2 , contradicting Theorem 2.4 as before. If only one is removable, then we can define a smooth map of a disk into $S^3 \setminus K$ sending the boundary to γ , implying the contradiction $\text{lk}(\gamma, K) = 0$. Now denote the two asymptotic orbits by $w_\infty(\{\pm\infty\} \times S^1) = P_\pm$. We find,

$$\text{lk}(P_\pm, K) = \text{lk}(P_\infty, K) = 1,$$

and if P_\pm is geometrically distinct from P_∞ ,

$$\text{lk}(P_\pm, P_\infty) = 0.$$

Therefore each orbit P_\pm is either P_∞ or is contained in L , simply covered in either case. We can determine the sign of each puncture by comparing the orientations of $w_\infty(\{\pm\infty\} \times S^1)$ with the orientations of the orbits. This allows four possibilities:

- (i) $P_+ = P_\infty$ (positive puncture) and $P_- = P_\infty$ (negative puncture)
- (ii) $P_+ \subset L$ (negative puncture) and $P_- \subset L$ (positive puncture)
- (iii) $P_+ = P_\infty$ (positive puncture) and $P_- \subset L$ (positive puncture)
- (iv) $P_+ \subset L$ (negative puncture) and $P_- = P_\infty$ (negative puncture)

Case (iv) is immediately excluded because both punctures can't be negative. Cases (i) and (ii) would both imply $E_{\omega_\infty}(\tilde{w}_\infty) = 0$, using again the fact that ω_∞ is exact and vanishes on L . We conclude that both punctures are positive, with $P_+ = P_\infty$ and $P_- \subset L$.

To apply this result to the sequence \tilde{u}_k , define a sequence of diffeomorphisms

$$\varphi_k : \mathbb{C} \setminus \{0\} \rightarrow \mathbb{C} \setminus \mathbb{D}$$

such that $\varphi_k(z) = e^{2\pi s_k} z$ for all z with $|z| \geq 2e^{-2\pi s_k}$. Then observe that $\tilde{w}_k \circ \psi^{-1}(z) = \tilde{u}_k \circ \varphi_k(z)$ whenever $|z| \geq 2e^{-2\pi s_k}$, thus after \mathbb{R} -translation, a subsequence of $\tilde{u} \circ \varphi_k$ converges in $C_{\text{loc}}^\infty(\mathbb{C} \setminus \{0\}, \mathbb{R} \times S^3)$ to

$$\tilde{w}_\infty = \tilde{w}_\infty \circ \psi^{-1} : \mathbb{C} \setminus \{0\} \rightarrow \mathbb{R} \times S^3,$$

which is asymptotic to P_∞ at ∞ and an orbit on L at 0. Clearly also $\varphi_k^* i \rightarrow i$ in $C_{\text{loc}}^\infty(S^2 \setminus \{0\})$. We have thus proved C_{loc}^∞ -convergence for Theorem 3.5 in the case $\chi(\dot{\Sigma}) \geq 0$.

The stable case. Now assume $\chi(\dot{\Sigma}) < 0$. The proof of Theorem 3.5 in this case will follow roughly the same sequence of steps as in Theorem 3.4, with a few important differences.

Step 1: Gradient bounds. We begin by establishing a bound

$$|d\tilde{u}_k(z)|_k \leq \frac{C}{\text{inrad}_k(z)}.$$

The proof is mostly the same as in Prop. 3.19. If a finite energy plane bubbles off, then it is asymptotic to an orbit P which (for topological reasons) cannot be a cover of P_∞ , and $\text{lk}(P, P_\infty) = 0$. The only remaining alternative (which is new in this situation) is that P is a meridian on one of the tori L_j , but this would imply $\text{lk}(P, K_j) \neq 0$, so $u_k(\dot{\Sigma})$ would have to intersect K_j for some large k . The argument excluding disk bubbles is the same as before.

As in the proof of Prop. 3.21, a subsequence of $(\Sigma, j_k, \{\infty\})$ converges to a stable nodal surface $\mathbf{S} = (S, j, \{p\}, \Delta, N)$. We again denote the connected components by $S = S_1 \cup \dots \cup S_N$ with corresponding punctured surfaces \dot{S}_j , choosing the labels so that $p \in S_1$. The gradient bound above implies that we can find constants $c_k^j \in \mathbb{R}$ such that

$$(a_k + c_k^j, u_k) \circ \varphi_k|_{\dot{S}_j} \rightarrow \tilde{v}^j : \dot{S}_j \rightarrow \mathbb{R} \times S^3$$

in $C_{\text{loc}}^\infty(\dot{S}_j, \mathbb{R} \times S^3)$, where $T\tilde{v}^j \circ j = \tilde{J}_\infty \circ T\tilde{v}^j$. Our main goal will be to show that \mathbf{S} has no double points and no boundary, but does have m unpaired nodes, one corresponding to each component of $\partial\Sigma$.

Step 2: Asymptotic behavior at p . The same arguments as in Prop. 3.21 show that p is a nonremovable puncture for $\tilde{v}^1 : \dot{S}_1 \rightarrow \mathbb{R} \times S^3$, and if P is an asymptotic limit then either $P = P_\infty$ (simply covered) or P is geometrically distinct from P_∞ , with $\text{lk}(P, P_\infty) = 0$. In the present context this last possibility implies that P is an n -fold cover of some orbit P_1 on one of the tori L_i , with $\text{lk}(P, K_i) = n \cdot \text{lk}(P_1, K_i) = -n$. (As always, $n \neq 0$ and is negative if the puncture is negative.) Then we can choose a small circle C about p such that $u_k(\varphi_k(C))$ is close to P for some large k , and thus construct a homotopy from P to P_∞ through $S^3 \setminus K$, implying

$$\text{lk}(P, K_j) = \text{lk}(P_\infty, K_j) > 0$$

for each component $K_j \subset K$. The left hand side is 0 if $K_j \neq K_i$, so this alternative can only happen if K is connected: in that case $-n = \text{lk}(P_\infty, K) = m$, so p is a negative puncture and P is an m -fold cover of P_1 . We shall use arguments similar to the proof of the non-stable case to show that this is also impossible.

Identify a punctured neighborhood of p in \dot{S}_1 with the positive half-cylinder via a holomorphic embedding

$$\psi : [0, \infty) \times S^1 \hookrightarrow S_1 \setminus \{p\},$$

and define $\tilde{w}_k = (\beta_k, w_k) = \tilde{u}_k \circ \varphi_k \circ \psi : [0, \infty) \times S^1 \rightarrow \mathbb{R} \times S^3$. These half-cylinders are \tilde{J}_k -holomorphic with the varying complex structures $(\varphi_k \circ \psi)^* j_k = \psi^* \varphi_k^* j_k$ on the domain, and they converge in C_{loc}^∞ (possibly after translation in $\mathbb{R} \times M$) to $\tilde{v}^1 \circ \psi$. Observe that $\varphi_k^* j_k \rightarrow j$ in C^∞ on any compact neighborhood of p , thus $\psi^* \varphi_k^* j_k \rightarrow \psi^* j = i$ in $C^\infty([0, \infty) \times S^1)$, not just on compact subsets; this follows from Lemma 3.22 below. The familiar argument then establishes a uniform bound on $|d\tilde{w}_k|$ over $[0, \infty) \times S^1$: the alternative is that $|d\tilde{w}_k(s_k, t_k)|$ blows up on some sequence with $s_k \rightarrow \infty$, in which case a \tilde{J}_∞ -holomorphic finite energy plane bubbles off, leading to the usual contradictions.

Due to the asymptotic behavior of \tilde{v}^1 , there exists a sequence $s_k \rightarrow \infty$ such that $w_k(s_k, \cdot)$ converges in $C^\infty(S^1, S^3)$ to a negatively oriented m -fold cover of the orbit P_1 . But the half-cylinders \tilde{w}_k are each asymptotic to P_∞ , thus we can (as in the stable case) pick a small open neighborhood $P_\infty \subset \mathcal{U} \subset M$ and define

$$s'_k = \min\{s \in [0, \infty) \mid w_k((s, \infty) \times S^1) \subset \mathcal{U}\}.$$

Clearly $s'_k > s_k$, thus $s'_k \rightarrow \infty$. Now define $\tilde{v}_k : [-s'_k, \infty) \times S^1 \rightarrow \mathbb{R} \times M$ by

$$\tilde{v}_k(s, t) = (b_k(s, t), v_k(s, t)) = (\beta_k(s + s'_k, t) - \beta_k(s'_k, 0), w_k(s + s'_k, t)).$$

These satisfy a uniform C^1 -bound and are \tilde{J}_k -holomorphic with respect to a sequence of complex structures which converge to i in $C_{\text{loc}}^\infty(\mathbb{R} \times S^1)$, hence a subsequence converges to a \tilde{J}_∞ -holomorphic finite energy cylinder

$$\tilde{v}_\infty = (b_\infty, v_\infty) : \mathbb{R} \times S^1 \rightarrow \mathbb{R} \times M.$$

As in the stable case, the loop $\gamma := v_\infty(\{0\} \times S^1)$ is necessarily non-trivial and not contained in a periodic orbit, thus \tilde{v}_∞ is nonconstant and $E_{\omega_\infty}(\tilde{v}_\infty) > \infty$. The usual topological constraints now imply that both punctures are nonremovable: in particular \tilde{v}_∞ is asymptotic to P_∞ at $+\infty$, and an m -fold covered orbit on L at $-\infty$, with both punctures positive. Denote the m -fold covered orbit on L by P_- .

This leads to the following contradiction. Let Ψ denote the natural trivialization of ξ_∞ along P_- defined by the intersection $TL \cap \xi_\infty$. Then if e_- is the asymptotic eigenfunction at the puncture, we claim $\text{wind}^\Psi(e_-) = 0$. Otherwise, we could find some s_0 near $-\infty$ such that for large k , the loop $u_k \circ \varphi_k \circ \psi(s_0, \cdot)$ winds nontrivially around P_- , and must therefore intersect L , which is a contradiction. Then Lemma 2.5 gives $\mu_{\text{CZ}}^{\Psi^-}(P_-) = 1$. In terms of the given trivialization Φ_∞ of $\xi_\infty|_M$, we have $\text{wind}_{P_-}^{\Phi_\infty}(\Psi) = -m$ and thus $\mu_{\text{CZ}}^{\Phi_\infty^-}(P_-) = 1 - 2m$. Now $\text{ind}(\tilde{w}) = \mu_{\text{CZ}}(\tilde{w}) = 3 + 1 - 2m = 4 - 2m$, and Theorem 2.4 gives

$$0 \leq 2 \text{wind}_\pi(\tilde{w}) \leq \text{ind}(\tilde{w}) - 2 + \#\Gamma_0 = 2 - 2m.$$

This is impossible, since we've assumed $m \geq 2$. We're left with the alternative that \tilde{v}^1 is positively asymptotic to P_∞ at the marked point p .

Before moving on, we should note the following lemma, which was used in the argument above to prove C^∞ -convergence on the noncompact set $[0, \infty) \times S^1$.

Lemma 3.22. *Let $A_k : \mathbb{D} \rightarrow \text{End}(T\mathbb{D})$ be a sequence of smooth sections of the tensor bundle $\text{End}(T\mathbb{D}) \rightarrow \mathbb{D}$ such that $A_k \rightarrow 0$ in $C^\infty(\mathbb{D})$. Then if $\psi : [0, \infty) \times S^1 \rightarrow \mathbb{D} \setminus \{0\}$ is the biholomorphic map $\psi(s, t) = e^{-2\pi(s+it)}$, the tensors $\psi^* A_k$ on $[0, \infty) \times S^1$ converge uniformly to 0 with all derivatives.*

Proof. Define the Euclidean metric on both \mathbb{D} and $[0, \infty) \times S^1$, and use the natural coordinates on each to write sections of $\text{End}(T\mathbb{D})$ or $\text{End}(T([0, \infty) \times S^1))$ as smooth real 2-by-2 matrix valued functions. If $\psi(s, t) = z$, then the first derivative of ψ at (s, t) and its inverse can be written as

$$(3.17) \quad \begin{aligned} D\psi(s, t) &= -2\pi e^{-2\pi(s+it)} = -2\pi z, \\ D\psi^{-1}(z) &= -\frac{1}{2\pi z} = -\frac{1}{2\pi} e^{2\pi(s+it)}, \end{aligned}$$

using the natural inclusion of \mathbb{C} in the space of real 2-by-2 matrices. Then

$$(\psi^* A_k)(s, t) = D\psi^{-1}(z) \circ A_k(z) \circ D\psi(s, t) = e^{2\pi it} A_k(z) e^{-2\pi it},$$

so $\|\psi^* A_k\|_{C^0} = \|A_k\|_{C^0} \rightarrow 0$ since the matrices on either side of $A_k(z)$ are orthogonal. We obtain convergence for all derivatives by observing that for any multiindex α , $\partial^\alpha(\psi^* A_k)(s, t)$ is a finite sum of expressions of the form

$$c \cdot U \cdot e^{2\pi it} \cdot D^j A_k(z)(z, \dots, z) \cdot e^{-2\pi it} \cdot V$$

where c is a real constant, U and V are constant unitary matrices (i.e. complex numbers of modulus 1), and $j \leq |\alpha|$. This is clearly true for $|\alpha| = 0$ and follows easily for all α by induction, using (3.17). The norm of this expression clearly goes to 0 uniformly in (s, t) as $k \rightarrow \infty$. \square

Step 3: Degeneration of j_k . Most of the hard work for this step was done in the proof of Prop. 3.21; in particular, the discussion surrounding Figures 6 and 7 applies in the present situation as well. The main difference here is that, since there are now orbits that are unlinked with P_∞ , it is not so trivial to exclude interior double points. Unpaired nodes, of course, will not be excluded at all; they will *replace* the boundary.

Claim: $\Delta \cap S_1$ is empty. This will follow from similar algebraic relations to the ones that were previously used only to exclude boundary double points. At any component $\alpha_j \subset \partial S_1$, the homotopy class of $v^1(\alpha_j)$ in $L_{f(j)}$ is fully determined by (3.12), giving the Maslov index $-2\widehat{m}_j$ with respect to the given trivialization Φ_∞ of $\xi_\infty|_M$.

The behavior at an unpaired node $w_j \in N \cap S_1$ is similarly constrained: by (3.14), the asymptotic limit P_j can only be one of the Morse-Bott orbits on some torus L_i . Then (3.13) tells us the torus in question must be $L_{g(j)}$, and since $\text{lk}(P_j, K_{g(j)}) = -1$, the covering number $n_j = 1$. So w_j is a

positive puncture, and repeating the argument from Step 2, the asymptotic eigenfunction has zero winding relative to the natural framing determined by $TL_{g(j)} \cap \xi_\infty$. Lemma 2.5 then gives Conley-Zehnder index 1 with respect to this framing. The framing itself has winding number -1 along P_j with respect to the trivialization Φ_∞ , which changes the Conley-Zehnder index to $-2 + 1 = -1$.

Likewise at an interior double point $z_j \in \Delta \cap \text{int } S_1$, the asymptotic limit P'_j must belong to a Morse-Bott torus, and summing (3.15) over all components $K_i \subset K$ we have

$$-n'_j = n'_j \text{lk}(P'_j, K) = \text{lk}(u_k(\partial_j \Sigma), K) = -m_j,$$

so z_j is a positive puncture with covering number m_j . The Conley-Zehnder index with respect to the natural framing on the torus is again 1, but now the framing winds $-m_j$ times with respect to Φ_∞ , giving index $-2m_j + 1$.

We now compute the Maslov index

$$\begin{aligned} \mu(\tilde{v}^1) &= 3 + \ell(-1) + \sum_{j=1}^q (1 - 2m_j) - 2 \sum_{j=1}^s \widehat{m}_j \\ &= 3 - \ell + q - 2 \left(\sum_{j=1}^q m_j + \sum_{j=1}^s \widehat{m}_j \right), \end{aligned}$$

and (2.3) gives

$$\begin{aligned} \text{ind}(\tilde{v}^1) &= \mu(\tilde{v}^1) - \chi(\dot{S}_1) + s \\ &= 3 - \ell + q - 2 \left(\sum_{j=1}^q m_j + \sum_{j=1}^s \widehat{m}_j \right) - (1 - s - \ell - q) + s \\ &= 2 + 2 \sum_{j=1}^q (1 - m_j) + 2 \sum_{j=1}^s (1 - \widehat{m}_j). \end{aligned}$$

We can assume that at least one of the sets ∂S_1 , $N \cap S_1$ and $\Delta \cap \text{int } S_1$ is nonempty, in which case v^1 approaches one of the tori L_i *somewhere*, while approaching P_∞ at the marked point p . It follows that the image of v^1 is not contained in any single periodic orbit, so $E_{\omega_\infty}(\tilde{v}^1) > 0$. Thus Theorem 2.4 gives

$$(3.18) \quad 0 \leq 2 \text{wind}_\pi(\tilde{v}^1) \leq 2 \left(\sum_{j=1}^q (1 - m_j) + \sum_{j=1}^s (1 - \widehat{m}_j) \right).$$

Recalling that always $m_j \geq 2$ and $\widehat{m}_j \geq 1$, we conclude $q = 0$ and $\widehat{m}_j = 1$ for each j , so $\Delta \cap \text{int } S_1$ is empty, and by the same argument as in the proof of Theorem 3.4, so is $\Delta \cap \partial S_1$.

Claim: $\partial S_1 = \emptyset$ and $\#N = m$. We've now established that S can have only one connected component (there are no double points to connect S_1 with anything else), thus $\overline{S}_r = \overline{S}_1 \cong \Sigma$, and $m = s + \ell$. We need to prove $s = 0$. Having just shown that everything on the right hand side of

(3.18) vanishes, we have $\text{wind}_\pi(\tilde{v}^1) = 0$, so $v : \dot{S}_1 \rightarrow S^3$ is immersed and transverse to X_∞ . But if $\partial S_1 \neq \emptyset$ this cannot be true, because $v^1(\partial S_1)$ and all orbits of X_∞ on L_j are meridians.

By the above results, S is a sphere with one marked point p and unpaired nodes $N = \{w_1, \dots, w_m\} \subset S \setminus \{p\}$, so we can identify it holomorphically with the Riemann sphere (S^2, i) , setting $\infty := p$ and $\Gamma' := N$. The diffeomorphisms $\varphi_k : \bar{S}_r \rightarrow \Sigma$ preserve ∞ , and restricting them to the interior they define diffeomorphisms

$$\varphi_k : S \setminus \Gamma' \rightarrow \text{int } \Sigma,$$

with $\varphi_k^* j_k \rightarrow i$ in $C_{\text{loc}}^\infty(S \setminus \Gamma')$. Moreover, after \mathbb{R} -translation, $\tilde{u}_k \circ \varphi_k \rightarrow \tilde{v}^1$ in $C_{\text{loc}}^\infty(S \setminus (\{\infty\} \cup \Gamma'), \mathbb{R} \times S^3)$, and \tilde{v}^1 has precisely the required asymptotic behavior at the punctures ∞ and $w_j \in \Gamma'$. This concludes the proof of C_{loc}^∞ -convergence for Theorem 3.5.

3.8. Convergence at the punctures. To finish proving Theorems 3.4 and 3.5, it remains only to establish that the sequences of maps $(a_k + c_k, u_k) \circ \varphi_k$ behave well on small neighborhoods of the punctures and boundary. This follows from the next three results.

Lemma 3.23. *Let j_k be a sequence of complex structures on $\dot{\mathbb{D}} := \mathbb{D} \setminus \{0\}$ such that $j_k \rightarrow i$ in $C_{\text{loc}}^\infty(\dot{\mathbb{D}})$, and take a sequence of biholomorphic maps*

$$\psi_k : ([0, R_k) \times S^1, i) \rightarrow (\dot{\mathbb{D}}, j_k)$$

for $R_k \in (0, \infty]$. Then after passing to a subsequence, $R_k \rightarrow \infty$ and ψ_k converges in $C_{\text{loc}}^\infty([0, \infty) \times S^1, \dot{\mathbb{D}})$ to a biholomorphic map $\psi : ([0, \infty) \times S^1, i) \rightarrow (\dot{\mathbb{D}}, i)$.

This can be proved by a routine bubbling off analysis for the embedded holomorphic maps $\psi_k^{-1} : (\dot{\mathbb{D}}, j_k) \hookrightarrow (\mathbb{R} \times S^1, i)$; we refer to [Wen05] for the details. With this preparation, we can reduce the problem of convergence at the boundary and ends to the following two statements; we'll prove only the second, since both use almost identical arguments. Let $\mathcal{H}_k = (\xi_k, X_k, \omega_k, J_k)$ be a sequence of stable Hamiltonian structures on a compact 3-manifold M with boundary, converging in C^∞ to $\mathcal{H}_\infty = (\xi_\infty, X_\infty, \omega_\infty, J_\infty)$, with associated almost complex structures $\tilde{J}_k \rightarrow \tilde{J}_\infty$. Assume also that the taming forms ω_k are exact.

Proposition 3.24. *Assume $P \subset M$ is a nondegenerate periodic orbit of X_k for all $k \leq \infty$. Suppose $\tilde{v}_k = (b_k, v_k) : [0, \infty) \times S^1 \rightarrow \mathbb{R} \times M$ is a sequence of finite energy \tilde{J}_k -holomorphic maps asymptotic to P , with uniformly bounded energy $E_k(\tilde{v}_k) < C$ and converging in $C_{\text{loc}}^\infty([0, \infty) \times S^1, \mathbb{R} \times M)$ to a \tilde{J}_∞ -holomorphic map $\tilde{v}_\infty = (b_\infty, v_\infty) : [0, \infty) \times S^1 \rightarrow \mathbb{R} \times M$, also asymptotic to P . Then for every sequence $s_k \rightarrow \infty$, the loops $v_k(s_k, \cdot)$ converge in $C^\infty(S^1, M)$ to a parametrization of P .*

Proposition 3.25. *Assume $L \subset M$ is a 2-torus which is tangent to all X_k and is a Morse-Bott torus for X_∞ . Let $R_k \rightarrow \infty$, and suppose $\tilde{v}_k =$*

$(b_k, v_k) : [0, R_k] \times S^1 \rightarrow \mathbb{R} \times M$ is a sequence of \tilde{J}_k -holomorphic maps converging in $C_{\text{loc}}^\infty([0, \infty) \times S^1, \mathbb{R} \times M)$ to a \tilde{J}_∞ -holomorphic half-cylinder $\tilde{v}_\infty = (b_\infty, v_\infty) : [0, \infty) \times S^1 \rightarrow \mathbb{R} \times M$, and satisfying a uniform energy bound $E_k(\tilde{v}_k) < C$. Assume also that $\tilde{v}_k(\{R_k\} \times S^1) \subset \{c_k\} \times L$ for some sequence $c_k \in \mathbb{R}$, and \tilde{v}_∞ is asymptotic to a periodic orbit $P \subset L$ which is homotopic along L to each of the loops $v_k(\{R_k\} \times S^1)$. Then for every sequence $s_k \in [0, R_k]$ with $s_k \rightarrow \infty$, the loops $v_k(s_k, \cdot)$ have a subsequence convergent in $C^\infty(S^1, M)$ to a closed orbit homotopic to P in L .

Proof. We claim first that for any sequence $s_k \leq R_k$ with $s_k \rightarrow \infty$,

$$\int_{[s_k, R_k] \times S^1} v_k^* \omega_k \rightarrow 0.$$

Indeed, the loop $v_k(s_0, \cdot)$ can be made arbitrarily close in $C^\infty(S^1, M)$ to a parametrization of P by choosing s_0 and k large enough. Then for any $\epsilon > 0$, the exactness of ω_k implies that we can find $k_0 \in \mathbb{N}$ and $s_0 \in [0, R_{k_0}]$ such that

$$\int_{[s_0, R_k] \times S^1} v_k^* \omega_k < \epsilon$$

for all $k \geq k_0$. Since $v_k^* \omega_k$ is positive, $\int_{[s_k, R_k] \times S^1} v_k^* \omega_k$ is bounded by this as soon as $s_k \geq s_0$, proving the claim.

From this and the uniform energy bound, we use the same argument as in Theorem 3.12 to derive a uniform bound on $|d\tilde{v}_k|$: else a nonconstant finite energy plane or half-plane with zero ω_∞ -energy bubbles off, contradicting Prop. 3.11.

Consider now a sequence $s_k \leq R_k$ with $s_k \rightarrow \infty$, and suppose $R_k - s_k$ is unbounded. Then a subsequence of

$$\tilde{w}_k : [-s_k, R_k - s_k] \times S^1 \rightarrow \mathbb{R} \times M : (s, t) \mapsto \tilde{v}_k(s + s_k, t)$$

converges (after \mathbb{R} -translation) in $C_{\text{loc}}^\infty(\mathbb{R} \times S^1, \mathbb{R} \times M)$ to a \tilde{J}_∞ -holomorphic finite energy cylinder $\tilde{w}_\infty = (\beta_\infty, w_\infty) : \mathbb{R} \times S^1 \rightarrow \mathbb{R} \times M$ with $E_{\omega_\infty}(\tilde{w}_\infty) = 0$. By Prop. 3.11, such an object is either constant or an orbit cylinder. To rule out the former, we claim

$$\int_{\{0\} \times S^1} w_\infty^* \lambda_\infty = \lim \int_{\{s_k\} \times S^1} v_k^* \lambda_k = \int_P \lambda_\infty =: Q_0 \neq 0.$$

Indeed, since $v_k(R_k, \cdot)$ is homotopic to P and $d\lambda_k$ vanishes along L , we can assume for k sufficiently large that

$$\left| Q_0 - \int_{\{R_k\} \times S^1} v_k^* \lambda_k \right| < \epsilon.$$

Then assuming also $\int_{[s_k, R_k] \times S^1} v_k^* \omega_k < \epsilon$ and using Lemma 3.15,

$$\begin{aligned} \left| Q_0 - \int_{\{s_k\} \times S^1} v_k^* \lambda_k \right| &= \left| Q_0 - \int_{\{R_k\} \times S^1} v_k^* \lambda_k + \int_{[s_k, R_k] \times S^1} v_k^* d\lambda_k \right| \\ &\leq (1 + C)\epsilon. \end{aligned}$$

Consequently, \tilde{w}_∞ is a trivial cylinder over a closed orbit with the same period as P .

If instead $R_k - s_k$ remains bounded as $k \rightarrow \infty$, we consider the maps

$$\tilde{w}_k : [-R_k, 0] \times S^1 \rightarrow \mathbb{R} \times M : (s, t) \mapsto \tilde{v}_k(s + R_k, t),$$

which satisfy the boundary condition $\tilde{w}_k(\{0\} \times S^1) \subset \{c_k\} \times L$. Then a subsequence converges in $C_{\text{loc}}^\infty((-\infty, 0] \times S^1, \mathbb{R} \times M)$ after \mathbb{R} -translation to a \tilde{J}_∞ -holomorphic finite energy half-cylinder $\tilde{w}_\infty : (-\infty, 0] \times S^1 \rightarrow \mathbb{R} \times M$, with $E_{\omega_\infty}(\tilde{w}_\infty) = 0$. Repeating the argument above, \tilde{w}_∞ parametrizes half of an orbit cylinder.

We've shown now that for every sequence $s_k \rightarrow \infty$ with $s_k \leq R_k$, the sequence of loops $v_k(s_k, \cdot)$ has a subsequence converging in $C^\infty(S^1, M)$ to a closed orbit of X_∞ . We claim finally that this orbit lies in L . If not, then we can find a sequence $s'_k \in (s_k, R_k)$ such that the loops $v_k(s'_k, \cdot)$ touch the boundary of a small neighborhood of L . But by the Morse-Bott condition, we may assume this neighborhood contains no other closed orbits of the same period, thus s'_k can have no subsequence for which $v_k(s'_k, \cdot)$ converges to an appropriate orbit, giving a contradiction. \square

4. THE MAIN CONSTRUCTION

4.1. Surgery and Lutz twists on transverse links. We now define precisely the type of surgery on contact manifolds that we wish to perform. In the following, S^1 is always defined to be the quotient \mathbb{R}/\mathbb{Z} .

Lemma 4.1. *Let (θ, ρ, ϕ) be the standard cylindrical polar coordinates on $S^1 \times \mathbb{R}^2$, oriented by the basis $(\partial_\theta, \partial_\rho, \partial_\phi)$. For $\rho \geq 0$, choose real-valued functions $f(\rho)$ and $g(\rho)$ such that $(\rho, \phi) \mapsto f(\rho)$ and $(\rho, \phi) \mapsto g(\rho)/\rho^2$ define smooth functions on \mathbb{R}^2 . Then*

$$\lambda := f(\rho) d\theta + g(\rho) d\phi$$

defines a smooth 1-form on $S^1 \times \mathbb{R}^2$, which is a positive contact form if and only if the following two conditions are met:

- (i) *The Wronskian $D(\rho) := f(\rho)g'(\rho) - f'(\rho)g(\rho) > 0$ for all $\rho > 0$.*
- (ii) *$f(0)g''(0) > 0$.*

In that case, the corresponding Reeb vector field is given by

$$(4.1) \quad X(\theta, \rho, \phi) = \frac{1}{D(\rho)}(g'(\rho)\partial_\theta - f'(\rho)\partial_\phi).$$

Proof. A simple calculation shows that

$$\lambda \wedge d\lambda = D(\rho) d\theta \wedge d\rho \wedge d\phi = \frac{D(\rho)}{\rho} d\theta \wedge dx \wedge dy,$$

where (x, y) are Cartesian coordinates on \mathbb{R}^2 . Then $\lim_{\rho \rightarrow 0} D(\rho)/\rho = D'(0) = f(0)g''(0)$, and it is straightforward to verify that the expression for X above satisfies $d\lambda(X, \cdot) \equiv 0$ and $\lambda(X) \equiv 1$. \square

Intuitively, these conditions on f and g mean that the curve $\rho \mapsto (f(\rho), g(\rho))$ always winds counterclockwise around the origin in the xy -plane, beginning on the x -axis with zero velocity and nonzero angular acceleration.

Let (M, ξ) be an oriented 3-manifold with a positive and cooriented contact structure, and suppose $K \subset M$ is an oriented knot which is *positively transverse* to ξ , i.e. its orientation matches the coorientation of ξ . A *Lutz twist* along K is defined as follows. By the contact neighborhood theorem, K has a solid torus neighborhood $N_K \subset M$ which can be identified with $S^1 \times \overline{B_\epsilon^2(0)}$, where $\overline{B_\epsilon^2(0)}$ is the closed ball of radius ϵ around the origin in \mathbb{R}^2 , such that $K = S^1 \times \{0\}$ and $\xi|_{N_K}$ is the kernel of

$$(4.2) \quad \lambda_0 := d\theta + \rho^2 d\phi.$$

using the cylindrical polar coordinates of Lemma 4.1. We then change ξ by replacing λ_0 on N_K with $\lambda_K := f(\rho) d\theta + g(\rho) d\phi$, where f and g are functions chosen as in Lemma 4.1 so that λ_K is a contact form, and furthermore:

- (1) There exists $\delta \in (0, \epsilon)$ such that $(f(\rho), g(\rho)) = (1, \rho^2)$ for $\rho \geq \delta$.
- (2) The trajectory $\rho \mapsto (f(\rho), g(\rho))$ rotates at least halfway around the origin for $\rho \in [0, \delta]$ (see Figures 9 and 10).

This operation produces a new contact structure $\xi_K = \ker \lambda_K$, such that there exists at least one radius $\rho_0 \in (0, \delta)$ at which $g(\rho_0) = 0$. This means the meridian $\{(0, \rho_0, \phi) \mid \phi \in \mathbb{R}/2\pi\mathbb{Z}\}$ is Legendrian and forms the boundary of an overtwisted disk, so that ξ_K is necessarily overtwisted. Relatedly, there is at least one radius $\rho_1 \in (0, \rho_0)$ at which $g'(\rho_1) = 0$ and $f'(\rho_1) > 0$, so that the Reeb vector field on the torus $\{\rho = \rho_1\}$ generates periodic orbits which are negatively oriented meridians. This detail will be important for constructing finite energy foliations in such neighborhoods.

The twists shown in Figures 9 and 10 may be called the “half Lutz twist” and “full Lutz twist” respectively: the former changes the homotopy class of ξ as a 2-plane distribution, while the latter does not (see [Ben83] for an explicit homotopy). The half Lutz twist is particularly important for the following reason: by an obstruction theory argument due originally to Lutz [Lut71, Lut77], any homotopy class of cooriented 2-plane distributions on M admits a positive contact structure, which can be obtained from any other ξ by half Lutz twists along some positively transverse link. See [Gei06] for a fuller discussion of this result.

We next generalize this to a twisting version of nontrivial Dehn surgery on contact manifolds. Assume $M = S^3$ with positive contact structure ξ and positively transverse knot $K \subset S^3$. Identify a neighborhood N_K of K once more with $S^1 \times B_\epsilon^2(0)$, requiring in particular that $\xi|_{N_K}$ be the kernel of $\lambda_0 = d\theta + \rho^2 d\phi$ and that the longitude $\{(\theta, \epsilon, 0) \mid \theta \in S^1\} \subset S^3$ be homologous to zero in $S^3 \setminus K$. Let $\lambda_1 = f_1(\rho) d\theta + g_1(\rho) d\phi$ be a contact form on N_K obtained from λ_0 by a Lutz twist as described above, choosing

f_1 and g_1 so that there is a radius $\rho_1 \in (0, \epsilon)$ at which $g'_1(\rho_1) = 0$ and $f'_1(\rho_1) > 0$, while $g'_1(\rho) > 0$ for all $\rho \in (\rho_1, \epsilon]$.

A *framing* of K is a number $p/q \in \mathbb{Q} \cup \{\infty\}$, where we assume p and q are relatively prime integers. Define now another solid torus $N' := S^1 \times \overline{B_\epsilon^2(0)}$, with canonical cylindrical polar coordinates (θ', ρ', ϕ') . Define also $\eta := \phi/2\pi$, $\eta' := \phi'/2\pi \in S^1$, so that the pairs (θ, η) , $(\theta', \eta') \in S^1 \times S^1$ give coordinates on the tori ∂N_K and $\partial N'$ respectively. Now choose $\delta \in (0, \rho_1)$ and define an embedding

$$\psi : N' \setminus (S^1 \times B_\delta^2(0)) \hookrightarrow N_K : (\theta', \rho', \phi') \mapsto (\theta(\theta', \phi'), \rho', \phi(\theta', \phi')),$$

where the map $(\theta', \phi') \mapsto (\theta, \phi)$ is determined by an orientation preserving diffeomorphism $\partial N' \mapsto \partial N_K$ of the form

$$(4.3) \quad \begin{pmatrix} \theta \\ \eta \end{pmatrix} = \begin{pmatrix} n & q \\ m & p \end{pmatrix} \begin{pmatrix} \theta' \\ \eta' \end{pmatrix},$$

for some matrix in $\mathrm{SL}(2, \mathbb{Z})$. A new manifold M_K is defined by removing $S^1 \times B_\delta^2(0) \subset N_K$ from S^3 and gluing in N' via this embedding. The topological type of M_K depends only on $p/q \in \mathbb{Q} \cup \{\infty\}$ (see [Sav99]).

The contact form λ_1 on N_K pulls back via ψ to a contact form λ_K on $N' \setminus (S^1 \times B_\delta^2(0))$, which in the coordinates (θ', ρ', ϕ') has the form

$$\begin{aligned} \lambda_K &= f_K(\rho') d\theta' + g_K(\rho') d\phi' \\ &= [nf_1(\rho') + 2\pi mg_1(\rho')] d\theta' + \left[\frac{q}{2\pi} f_1(\rho') + pg_1(\rho') \right] d\phi'. \end{aligned}$$

Clearly $\xi_K := \ker \lambda_K$ has a natural extension to $M_K \setminus N'$, and we can extend f_K and g_K to $\rho \in [0, \delta]$ so that λ_K becomes a contact form on N' .

We will refer to the operation described above as a *rational twist surgery* along K , or *integral* in the case where $p/q \in \mathbb{Z} \cup \{\infty\}$, i.e. $q = \pm 1$ or 0 . Observe that when $q = 0$, we can choose the surgery matrix to be the identity, which gives simply a Lutz twist along K . By the theorem of Lickorish [Lic62] and Wallace [Wal60], every closed oriented 3-manifold M can be obtained by integral surgery along some link $K \subset S^3$; then making K positively transverse by a C^0 -perturbation, the procedure we've described proves the result of Martinet [Mar71] that every such 3-manifold admits a cooriented and positive contact structure ξ .

Let $N \subset S^3$ be the union of all the solid tori removed from S^3 in the above gluing, and let $N' \subset M$ be the corresponding solid tori that are glued in, so there's a natural diffeomorphism $S^3 \setminus N = M \setminus N'$. The Lutz argument now provides a link $K_1 \subset M$, positively transverse to ξ_K , such that the contact structure ξ_1 obtained by half Lutz twists along the components of K_1 may represent any desired homotopy class. In particular, we can specify the homotopy class of ξ_1 over the complement of a small 3-ball $B \subset M$ by choosing any link K' representing the appropriate class in $H_1(M)$, then perturbing it to be positively transverse—note that we're thus free to assume $K' \subset M \setminus N'$. We can also assume $B \subset M \setminus N'$, and then the homotopy class of ξ' over B can be changed as needed by twisting

along a transverse link $K'' \subset B$ with the appropriate self-linking number. In summary, we can assume the transverse link K_1 needed to change the homotopy class of ξ_K lies in $M \setminus N' = S^3 \setminus N$, and this leads to the following statement of the famous Lutz-Martinet theorem.

Theorem 4.2 (Lutz, Martinet). *Given a closed oriented 3-manifold M with a cooriented 2-plane distribution α , there exists a positive contact structure ξ homotopic to α , and (M, ξ) can be obtained from the tight three-sphere (S^3, ξ_0) by a rational twist surgery along some transverse link.*

Remark 4.3. By Eliashberg's classification theorem for overtwisted contact structures [Eli89], the procedure above produces every overtwisted contact structure on every closed 3-manifold.

The main goal of this paper is to construct finite energy foliations on contact manifolds obtained from (S^3, ξ_0) by twist surgeries. The following result will be helpful for establishing that these foliations can be made to have certain nice properties, e.g. that all punctures are positive and all orbits are simply covered.

Proposition 4.4. *For the surgery in Theorem 4.2, we can assume without loss of generality any or all of the following:*

- (1) *The surgery is integral.*
- (2) *ξ is overtwisted.*
- (3) *For each component $K_j \subset K$, let $\rho_1 \in (0, \epsilon)$ be the largest radius where $g'_1(\rho_1) = 0$. Then for all $\rho \in (0, \rho_1]$,*

$$f'_K(\rho)g''_K(\rho) - f''_K(\rho)g'_K(\rho) > 0.$$

- (4) *If the surgery at K_j is topologically nontrivial (i.e. $q \neq 0$), ρ_1 is the radius above and $r \in (0, \epsilon)$ is the smallest radius at which $f'_K(r)/g'_K(r) = f'_K(\rho_1)/g'_K(\rho_1)$, then*

$$\frac{f'_K(r)}{g'_K(r)} - \frac{f''_K(0)}{g''_K(0)}$$

is positive and close to 0.

Proof. The Lickorish-Wallace theorem guarantees that integral surgeries are sufficient. If the surgery is topologically nontrivial (i.e. not merely a Lutz twist) at each component of K , then the contact structure ξ defined as above need not generally be overtwisted. We can, however, *make* it overtwisted by performing an extra *full* Lutz twist along a transverse knot disjoint from K ; this doesn't change the homotopy class of ξ . Condition (3) simply means that the trajectory $\rho \mapsto (f(\rho), g(\rho))$ in \mathbb{R}^2 has nonzero *inward* acceleration for all $\rho \in (0, \rho_1]$. Condition (4) is a relation between the slopes of the trajectory at $\rho = 0$ and $\rho = r$, and can always be achieved by changing f_K and g_K near $\rho = 0$. This change may involve an extra half Lutz twist, which changes the homotopy class of ξ , but it can be changed back by adding Lutz twists along extra transverse knots. \square

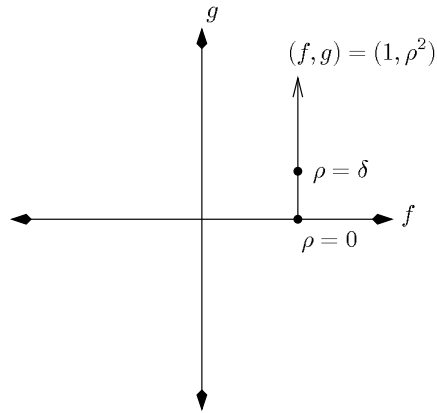

FIGURE 8. The trajectory $\rho \mapsto (f(\rho), g(\rho))$ for the contact structure $\lambda_0 = f(\rho)d\theta + g(\rho)d\phi = d\theta + \rho^2 d\phi$

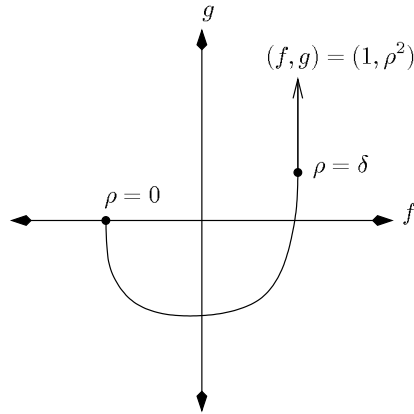

FIGURE 9. Half Lutz twist of λ_0

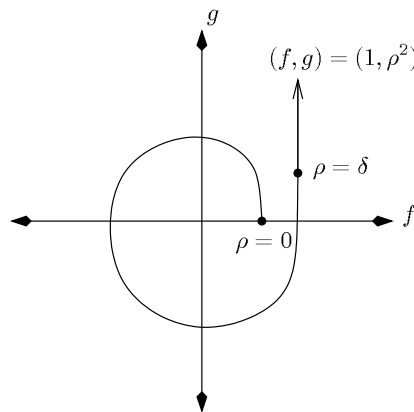

FIGURE 10. Full Lutz twist of λ_0

It will be helpful to know that transverse links in the tight 3–sphere (S^3, ξ_0) can be assumed after transverse isotopy to approximate covers of Hopf circles, as the latter admit coordinate neighborhoods in which the standard contact form takes an especially simple form. In the following, we view S^3 as the unit sphere in \mathbb{C}^2 , with

$$(4.4) \quad \lambda_0(z)v := \frac{1}{2}\langle iz, v \rangle,$$

for $z \in S^3 \subset \mathbb{C}^2$ and $v \in T_z S^3 \subset \mathbb{C}^2$, where $\langle \cdot, \cdot \rangle$ is the standard Euclidean inner product. It was shown by Bennequin [Ben83] that all transverse links in the standard contact \mathbb{R}^3 are transversely isotopic to closed braids about the z –axis. Using a contact embedding of \mathbb{R}^3 into the tight 3–sphere, one can then prove the following (see [Wen05] for details):

Lemma 4.5. *Let $K \subset S^3$ be a link positively transverse to the standard contact structure ξ_0 . Then for each component $K_j \subset K$ there is a smooth immersion $F_j : [0, 1] \times S^1 \rightarrow S^3$ such that $F_j(1, \cdot) : S^1 \rightarrow S^3$ parametrizes K_j , $F_j(0, t) = (e^{2\pi i k_j t}, 0)$ for some $k_j \in \mathbb{N}$, and for all fixed $\tau \in (0, 1]$, the collection of maps $F_j(\tau, \cdot) : S^1 \rightarrow S^3$ parametrizes a transverse link.*

4.2. Some simple foliations in $S^1 \times \mathbb{R}^2$. In this section we construct stable finite energy foliations on the local neighborhoods that arise from twist surgery on transverse links. Let $M = S^1 \times \mathbb{R}^2$, with cylindrical polar coordinates (θ, ρ, ϕ) as in the previous section. Then using Lemma 4.1, define a positive contact form

$$\lambda = f(\rho) d\theta + g(\rho) d\phi,$$

where

$$D(\rho) := f(\rho)g'(\rho) - f'(\rho)g(\rho) > 0 \text{ for all } \rho > 0, \text{ and } f(0)g''(0) > 0.$$

Notice that smoothness at $\rho = 0$ requires $g(0) = f'(0) = g'(0) = 0$.

The contact structure $\xi = \ker \lambda$ is spanned for all $\rho > 0$ by the two vector fields

$$(4.5) \quad v_1(\theta, \rho, \phi) = \partial_\rho, \quad v_2(\theta, \rho, \phi) = \frac{1}{D(\rho)}(-g(\rho)\partial_\theta + f(\rho)\partial_\phi),$$

and the Reeb vector field X is given by (4.1). The flow of X and its linearization are quite easy to compute, leading to the following characterization of periodic orbits:

Proposition 4.6. *Suppose $r > 0$ and $f'(r)/2\pi g'(r) = p/q \in \mathbb{Q} \cup \{\infty\}$ for relatively prime integers p and q , whose signs match the signs of $f'(r)$ and $g'(r)$ respectively. Then the torus*

$$L_r := \{\rho = r\} \subset M$$

is foliated by closed orbits of the form

$$x(t) = \left(\theta_0 + \frac{g'(r)}{D(r)}t, r, \phi_0 - \frac{f'(r)}{D(r)}t \right) = \left(\theta_0 + \frac{q}{T}t, r, \phi_0 - \frac{2\pi p}{T}t \right),$$

all having minimal period

$$(4.6) \quad T = q \frac{D(r)}{g'(r)} = 2\pi p \frac{D(r)}{f'(r)}$$

(in the cases where $f'(r) = p = 0$ or $g'(r) = q = 0$, pick whichever one of these expressions makes sense). The torus is Morse-Bott if and only if the function $\rho \mapsto f'(\rho)/g'(\rho)$ (or its reciprocal) has nonvanishing derivative at r .

Likewise, the circle

$$P := \{\rho = 0\} \subset M$$

is a closed orbit with minimal period $T = |f(0)|$. For $k \in \mathbb{N}$, its k -fold cover P^k is degenerate if and only if $\frac{kf''(0)}{2\pi g''(0)} \in \mathbb{Z}$, and otherwise has

$$\mu_{CZ}^{\Phi_0}(P^k) = 2 \left\lfloor -\frac{kf''(0)}{2\pi g''(0)} \right\rfloor + 1,$$

where Φ_0 is the natural symplectic trivialization of ξ along P induced by the coordinates. Here $\lfloor x \rfloor$ means the greatest integer $\leq x$.

In terms of the curve $\rho \mapsto (f(\rho), g(\rho))$ in \mathbb{R}^2 , this says that the torus L_r is Morse-Bott when the slope of the curve has nonvanishing derivative at r . The nondegeneracy and index of any cover of P depend similarly on the slope of this curve as it pushes off from the x -axis at $\rho = 0$.

We've chosen the vector fields v_1 and v_2 above so that $d\lambda(v_1, v_2) \equiv 1$, i.e. they give a symplectic trivialization of ξ over $M \setminus P$. Use these now to define an admissible complex multiplication J by

$$(4.7) \quad Jv_1 = \beta(\rho)v_2, \quad Jv_2 = -\frac{1}{\beta(\rho)}v_1$$

for some smooth function $\beta(\rho)$. The behavior of β near 0 can be chosen to ensure that J is smooth at $\rho = 0$. Then an \mathbb{R} -invariant almost complex structure \tilde{J} on $\mathbb{R} \times M$ is defined in the standard way, and we seek maps $\tilde{u} : (S, j) \rightarrow (\mathbb{R} \times M, \tilde{J})$ defined on a Riemann surface (S, j) and satisfying $T\tilde{u} \circ j = \tilde{J} \circ T\tilde{u}$. Choosing conformal coordinates (s, t) on S , the map u can be written in coordinates as $u(s, t) = (\theta(s, t), \rho(s, t), \phi(s, t))$, and then the Cauchy-Riemann equation becomes

$$(4.8) \quad \begin{aligned} a_s &= f\theta_t + g\phi_t & \rho_s &= \frac{1}{\beta}(f'\theta_t + g'\phi_t) \\ a_t &= -f\theta_s - g\phi_s & \rho_t &= -\frac{1}{\beta}(f'\theta_s + g'\phi_s) \end{aligned}$$

Given two concentric tori $L_{\pm} = \{\rho = \rho_{\pm}\}$, each foliated by periodic orbits that are homologous (up to a sign) in $H_1(M \setminus P)$, we shall now construct a stable finite energy foliation of the region between them, each leaf being a cylinder with ends asymptotic to orbits at L_- and L_+ respectively (Figure 11). In particular, suppose there are two radii ρ_{\pm} with

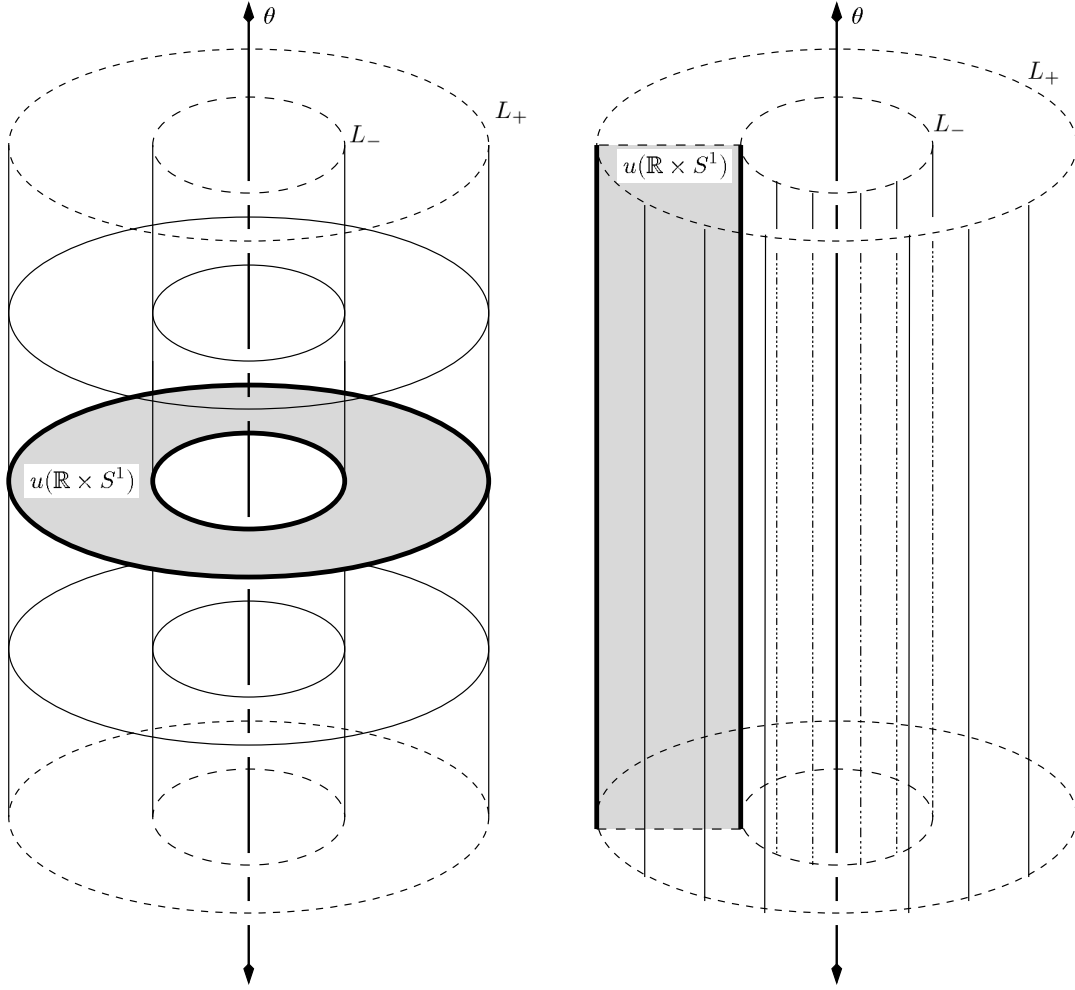

FIGURE 11. Concentric tori with homologous periodic orbits connected by a finite energy cylinder. On the left is the case where $g'(\rho_{\pm}) = 0$, so the orbits are parallel to ∂_{ϕ} . On the right, $f'(\rho_{\pm}) = 0$ gives orbits parallel to ∂_{θ} .

$0 < \rho_- < \rho_+$, such that

$$\frac{f'(\rho_{\pm})}{2\pi g'(\rho_{\pm})} = \frac{p}{q} \in \mathbb{Q} \cup \{\infty\} \quad \text{and} \quad \frac{f'(\rho)}{2\pi g'(\rho)} \neq \frac{p}{q} \text{ for } \rho \in (\rho_-, \rho_+).$$

A choice of sign must be made for p and q : for reasons that will become clear shortly, let us choose both so that the quantity $qf'(\rho) - 2\pi pg'(\rho)$ is positive for $\rho \in (\rho_-, \rho_+)$. The two tori L_{\pm} are each foliated by families of periodic orbits, of the form

$$x_{\pm}(t) = \left(\theta_0 + \frac{q_{\pm}}{T_{\pm}} t, \rho_{\pm}, \phi_0 - \frac{2\pi p_{\pm}}{T_{\pm}} t \right).$$

Here p_{\pm} and q_{\pm} are the same as p and q up to a sign, which must be chosen so that the periods $T_{\pm} = \frac{q_{\pm}D(\rho_{\pm})}{g'(\rho_{\pm})} = \frac{2\pi p_{\pm}D(\rho_{\pm})}{f'(\rho_{\pm})}$ are positive. Fixing values of θ_0 and ϕ_0 , suppose $\tilde{u} = (a, u) : \mathbb{R} \times S^1 \rightarrow \mathbb{R} \times M$ is a map of the form

$$(4.9) \quad (a(s, t), \theta(s, t), \rho(s, t), \phi(s, t)) = (a(s), \theta_0 + qt, \rho(s), \phi_0 - 2\pi pt).$$

Then using (4.8), the Cauchy-Riemann equation for \tilde{u} reduces to the pair of ordinary differential equations

$$(4.10a) \quad \frac{d\rho}{ds} = \frac{1}{\beta(\rho)}(qf'(\rho) - 2\pi pg'(\rho)),$$

$$(4.10b) \quad \frac{da}{ds} = qf(\rho) - 2\pi pg(\rho).$$

These have unique solutions for any choice of $\rho(0) \in (\rho_-, \rho_+)$ and $a(0) \in \mathbb{R}$. Notice that due to our sign convention for p and q , the right hand side of (4.10a) is always positive, thus $\lim_{s \rightarrow \pm\infty} \rho(s) = \rho_{\pm}$, and we see that $u(s, \cdot)$ converges in C^{∞} to parametrizations of the orbits x_{\pm} as $s \rightarrow \pm\infty$. It follows then from (1.1) and Stokes' theorem that \tilde{u} has finite energy $E(\tilde{u}) \leq T_+ + T_-$. We shall refer to this solution as a *cylinder of type* (p, q) . An example is shown in Figure 13.²

It is clear from (4.10b) that a is a proper function with asymptotically linear growth to $\pm\infty$, as the condition $D(\rho) > 0$ guarantees that $\lim_{s \rightarrow \pm\infty} a'(s) = qf(\rho_{\pm}) - 2\pi pg(\rho_{\pm})$ cannot be zero. This expression determines the sign of the puncture at $s = \pm\infty$ as $\pm \operatorname{sgn}(qf(\rho_{\pm}) - 2\pi pg(\rho_{\pm}))$. To put this in a more revealing form, write $f_{\pm} := f(\rho_{\pm})$, $f'_{\pm} := f'(\rho_{\pm})$ etc., and observe that by assumption there is a nonzero number

$$c_{\pm} = \frac{2\pi p}{f'_{\pm}} = \frac{q}{g'_{\pm}}.$$

Then the expression above for the sign becomes $\pm \operatorname{sgn}[c_{\pm}(f_{\pm}g'_{\pm} - f'_{\pm}g_{\pm})] = \pm \operatorname{sgn}(c_{\pm})$ since $D(\rho_{\pm})$ is positive. Now if both tori L_{\pm} satisfy the Morse-Bott condition, then $0 \neq f'_{\pm}g''_{\pm} - f''_{\pm}g'_{\pm} = -\frac{1}{c_{\pm}}(qf''_{\pm} - 2\pi pg''_{\pm})$, and our sign convention for p and q implies $\operatorname{sgn}(qf''_{\pm} - 2\pi pg''_{\pm}) = \mp 1$, thus $\operatorname{sgn}(f'_{\pm}g''_{\pm} - f''_{\pm}g'_{\pm}) = -\operatorname{sgn}(c_{\pm}) \operatorname{sgn}(qf''_{\pm} - 2\pi pg''_{\pm}) = \pm \operatorname{sgn}(c_{\pm})$, and we have

$$(4.11) \quad \text{sign of puncture at } L_{\pm} = \operatorname{sgn}(f'_{\pm}g''_{\pm} - f''_{\pm}g'_{\pm}).$$

This means that in the Morse-Bott case, the sign of a puncture approaching L_r is positive if and only if the counterclockwise trajectory $\rho \mapsto (f(\rho), g(\rho))$ is accelerating *inward* at $\rho = r$, and negative if it accelerates outward.

The equations (4.10) can be thought of as defining a direction field in the subset $(\rho_-, \rho_+) \times \mathbb{R}$ of the ρa -plane, which integrates to a one-dimensional foliation. Since (4.10b) defines $a(s)$ only up to a constant, this foliation is invariant under the natural \mathbb{R} -action on the a -coordinate. Meanwhile the set of trajectories $t \mapsto (\theta_0 + qt, \phi_0 - 2\pi pt) \in S^1 \times \mathbb{R}/2\pi\mathbb{Z}$ for all choices of θ_0 and ϕ_0 defines another one-dimensional foliation. Putting

²Thanks to Joel Fish for providing Figures 13 and 14.

these together as in (4.9) creates a two-dimensional foliation of the region $\{(a, \theta, \rho, \phi) \in \mathbb{R} \times M \mid \rho \in (\rho_-, \rho_+)\}$ by \tilde{J} -holomorphic cylinders with uniformly bounded energy, and it projects to a one-dimensional foliation of $\{\rho \in (\rho_-, \rho_+)\} \subset M$. We may assume without loss of generality that f and g are chosen so that both tori $L_{\rho_{\pm}}$ are Morse-Bott. Then using the frame (v_1, v_2) to trivialize ξ over this region, it follows from Lemma 2.5 and (1.6) that each leaf \tilde{u} has $\#\Gamma_0 = 0$ and $\text{ind}(\tilde{u}) = 2$, so Theorem 2.6 implies that the foliation is stable.

We can extend this foliation to $\rho = \rho_{\pm}$ by adding the cylinders over periodic orbits at L_{\pm} . Moreover, if there exists a radius $\rho_0 \in (0, \rho_-)$ such that ρ_0 and ρ_- satisfy the same conditions as ρ_- and ρ_+ , then we can repeat this construction for $\rho \in (\rho_0, \rho_-)$ and thus extend the foliation to the region $\rho \in [\rho_0, \rho_+]$.

It remains to extend the foliation further toward the center in the case where there is no $\rho < \rho_-$ with $f'(\rho)/2\pi g'(\rho) = p/q$. To that end, let us redefine our notation with $\rho_- = 0$ and $L_+ = \{\rho = \rho_+\}$; choose $\rho_+ > 0$ so that

$$\frac{f'(\rho_+)}{2\pi g'(\rho_+)} = \frac{p}{q} \in \mathbb{Q} \cup \{\infty\} \quad \text{and} \quad \frac{f'(\rho)}{2\pi g'(\rho)} \neq \frac{p}{q} \text{ for } \rho \in (0, \rho_+).$$

Choose the signs of p and q so that $qf' - 2\pi pg' > 0$ for $\rho \in (0, \rho_+)$, and consider once more the family of \tilde{J} -holomorphic cylinders defined by

$$\tilde{u} = (a, u) : \mathbb{R} \times S^1 \rightarrow \mathbb{R} \times M : (s, t) \mapsto (a(s), \theta_0 + qt, \rho(s), \phi_0 - 2\pi pt),$$

where $\rho(s)$ and $a(s)$ satisfy the ODEs (4.10) with $\rho(0) \in (0, \rho_+)$. Once again $u(s, \cdot)$ converges in C^∞ as $s \rightarrow \infty$ to some parametrization of a simply covered orbit $P_+ \subset L_+$, and (4.11) gives the sign of this puncture as

$$\sigma_+ := \text{sgn}(f'_+ g''_+ - f''_+ g'_+).$$

Define $F(\rho)$ to be the right hand side of (4.10a). The requirement that J be smooth at $\rho = 0$ implies that $\beta(\rho)$ is bounded away from zero as $\rho \rightarrow 0$, thus $\lim_{\rho \rightarrow 0} F(\rho) = 0$, and we conclude that $\rho(s) \rightarrow 0$ as $s \rightarrow -\infty$.

We must now distinguish between two cases in order to understand fully the behavior as $s \rightarrow -\infty$. If $q \neq 0$, $u(s, \cdot)$ converges to the $|q|$ -fold cover of P , and the sign of the puncture at $-\infty$ is

$$\sigma_- := -\text{sgn}(q) \cdot \text{sgn}[f(0)] = -\text{sgn}(q) \cdot \text{sgn}[g''(0)],$$

where we're using the fact that $f(0)g''(0) > 0$. We can put this in a more geometrically revealing form analogous to (4.11): observe first that if $P^{|q|}$ is nondegenerate, Prop. 4.6 implies $qf''_-/2\pi g''_- \notin \mathbb{Z}$ and thus $f''_-/2\pi g''_- \neq f'_+/2\pi g'_+ = p/q$. Meanwhile our sign convention $qf' - 2\pi pg' > 0$ for $\rho \in (0, \rho_+)$ implies

$$qf''_- - 2\pi pg''_- > 0.$$

This together with the above expression for σ_- yields

$$\frac{1}{2\pi} \sigma_- \left(\frac{f''_-}{g''_-} - \frac{f'_+}{g'_+} \right) = \sigma_- \left(\frac{f''_-}{2\pi g''_-} - \frac{p}{q} \right) < 0,$$

hence

$$(4.12) \quad \sigma_- = \operatorname{sgn} \left(\frac{f'_+}{g'_+} - \frac{f''_-}{g''_-} \right).$$

Thus when $P^{|q|}$ is nondegenerate, σ_- depends on whether the slope of the trajectory $\rho \mapsto (f(\rho), g(\rho))$ at $\rho = 0$ is greater than or less than the slope at $\rho = \rho_+$.

We now have a foliation of the region $\rho \in (0, \rho_+)$ by an \mathbb{R} -invariant family of finite energy cylinders, each convergent to $P^{|q|}$ at one end and a simply covered orbit $P_+ \subset L_+$ at the other. These together with the orbit cylinder over P form a finite energy foliation in the region $\{\rho < \rho_+\}$. Figure 12, right, shows an example with $(p, q) = (0, 1)$. An example with p and q both nonzero is shown in Figure 14.

Stability for these cylinders is a somewhat more subtle question than before. Assume $P^{|q|}$ is nondegenerate and L_+ is Morse-Bott. Then since $P^{|q|}$ has odd Conley-Zehnder index, Lemma 2.5 and Theorem 2.4 imply that each solution \tilde{u} above has $\operatorname{ind}(\tilde{u}) \geq 2$; in general however, this inequality can be strict. We claim that the functions f and g can always be adjusted near 0 so that $\operatorname{ind}(\tilde{u}) = 2$; in this case Theorem 2.6 will imply that the corresponding foliation is stable. Let Φ_0 be the symplectic trivialization of ξ along P defined by the Cartesian coordinates, and extend this over $\{\rho \leq \rho_+\}$. Then accounting for the orientation of ξ determined by λ , we have

$$\operatorname{wind}_{P_+}^{\Phi_0}(v_1) = -\sigma_+ \cdot \operatorname{sgn}[f(0)] \cdot p,$$

and hence

$$(4.13) \quad \mu_{\text{CZ}}^{\Phi_0 \mp}(P_+) = \sigma_+ (1 - 2 \operatorname{sgn}[f(0)] \cdot p).$$

In order to write $\mu_{\text{CZ}}^{\Phi_0}(P^{|q|})$ in a convenient form, we compute

$$\begin{aligned} \left\lfloor -\frac{|q|f''_-}{2\pi g''_-} \right\rfloor &= \left\lfloor -\operatorname{sgn}(q) \left(\frac{qf''_- - 2\pi p g''_-}{2\pi g''_-} + p \right) \right\rfloor \\ &= \left\lfloor \sigma_- \frac{qf''_- - 2\pi p g''_-}{2\pi |g''_-|} \right\rfloor - \operatorname{sgn}(q) \cdot p. \end{aligned}$$

Then using the index formula in Prop. 4.6,

$$\begin{aligned} \operatorname{ind}(\tilde{u}) &= \sigma_+ \cdot \mu_{\text{CZ}}^{\Phi_0 \mp}(P_+) + \sigma_- \cdot \mu_{\text{CZ}}^{\Phi_0}(P^{|q|}) \\ &= 1 - 2 \operatorname{sgn}[f(0)] \cdot p + \sigma_- \left(2 \left\lfloor -\frac{|q|f''_-}{2\pi g''_-} \right\rfloor + 1 \right) \\ &= 1 + \sigma_- - (2 \operatorname{sgn}[f(0)] \cdot p) - (2\sigma_- \cdot \operatorname{sgn}(q) \cdot p) \\ &\quad + 2\sigma_- \left\lfloor \sigma_- \frac{qf''_- - 2\pi p g''_-}{2\pi |g''_-|} \right\rfloor \\ &= 1 + \sigma_- + 2\sigma_- \left\lfloor \sigma_- \frac{qf''_- - 2\pi p g''_-}{2\pi |g''_-|} \right\rfloor. \end{aligned}$$

If $\sigma_- = 1$ this gives

$$\text{ind}(\tilde{u}) = 2 + 2 \left\lfloor \frac{qf''_- - 2\pi pg''_-}{2\pi|g''_-|} \right\rfloor,$$

or if $\sigma_+ = -1$,

$$\text{ind}(\tilde{u}) = 2 \left\lfloor \frac{qf''_- - 2\pi pg''_-}{2\pi|g''_-|} \right\rfloor,$$

where $\lceil x \rceil$ denotes the smallest integer $\geq x$. Recalling $qf''_- - 2\pi pg''_- > 0$, we see indeed that in both cases $\text{ind}(\tilde{u}) \geq 2$, with equality if and only if $qf''_- - 2\pi pg''_-$ is sufficiently small. This can always be achieved by adjusting the slope of the trajectory $\rho \mapsto (f(\rho), g(\rho))$ for ρ near 0, without creating any new points at which $qf'(\rho) - 2\pi pg'(\rho) = 0$. The key point is to make the slopes of the trajectory $\rho \mapsto (f(\rho), g(\rho))$ at $\rho = 0$ and $\rho = \rho_+$ as close as possible.

If on the other hand $q = 0$, we have $p = -\text{sgn}(g''_-) = -\text{sgn}[f(0)] = \pm 1$ and $\lim_{s \rightarrow -\infty} u(s, t) = (\theta_0, 0) \in P \subset S^1 \times \mathbb{R}^2$. In fact, since

$$\lim_{\rho \rightarrow 0} F'(\rho) = -\frac{2\pi pg''(0)}{\lim_{\rho \rightarrow 0} \beta(\rho)} \neq 0,$$

one can easily show that $\rho(s)$ converges exponentially fast to 0, and plugging this behavior into the equation $\rho' = F(\rho)$, so does its derivative. We now claim that $a(s)$ is bounded at $-\infty$. For this it suffices to prove that the integral

$$\int_{-\infty}^0 \frac{da}{ds} ds = -2\pi p \int_{-\infty}^0 g(\rho(s)) ds$$

converges. We know $\rho'(s)$ satisfies a bound of the form $|\rho'(s)| \leq Me^{\lambda s}$ with $\lambda > 0$. Since g' is continuous and ρ stays within a bounded interval for all s , we have

$$\begin{aligned} |g(\rho(s))| &= \left| \int_{-\infty}^s \frac{d}{d\sigma} g(\rho(\sigma)) d\sigma \right| \leq \int_{-\infty}^s |g'(\rho(\sigma))| |\rho'(\sigma)| d\sigma \\ &\leq M_1 \int_{-\infty}^s e^{\lambda\sigma} d\sigma = M_2 e^{\lambda s} \end{aligned}$$

for some constant $M_2 > 0$. Then $\int_{-\infty}^0 |g(\rho(s))| ds < \infty$ and the claim follows. It's clear now that \tilde{u} has finite area as $s \rightarrow -\infty$, thus Gromov's removable singularity theorem implies that \tilde{u} can be extended smoothly to a finite energy plane $\tilde{v} = (b, v) : \mathbb{C} \rightarrow \mathbb{R} \times M$ with $\tilde{v}(e^{2\pi(s+it)}) = \tilde{u}(s, t)$ and $v(0) = (\theta_0, 0) \in S^1 \times \mathbb{R}^2$. The set of all such planes forms a finite energy foliation in the region $\{\rho < \rho_+\}$. Each is positively asymptotic to a simply covered orbit $P_+ \subset L_+$, and transverse to the central orbit P (Figure 12, left). From (4.13), we find

$$\text{ind}(\tilde{v}) = \mu_{\text{CZ}}^{\Phi_0^-}(P_+) - \chi(\mathbb{C}) = (1 - (-2)) - 1 = 2,$$

so the foliation is stable.

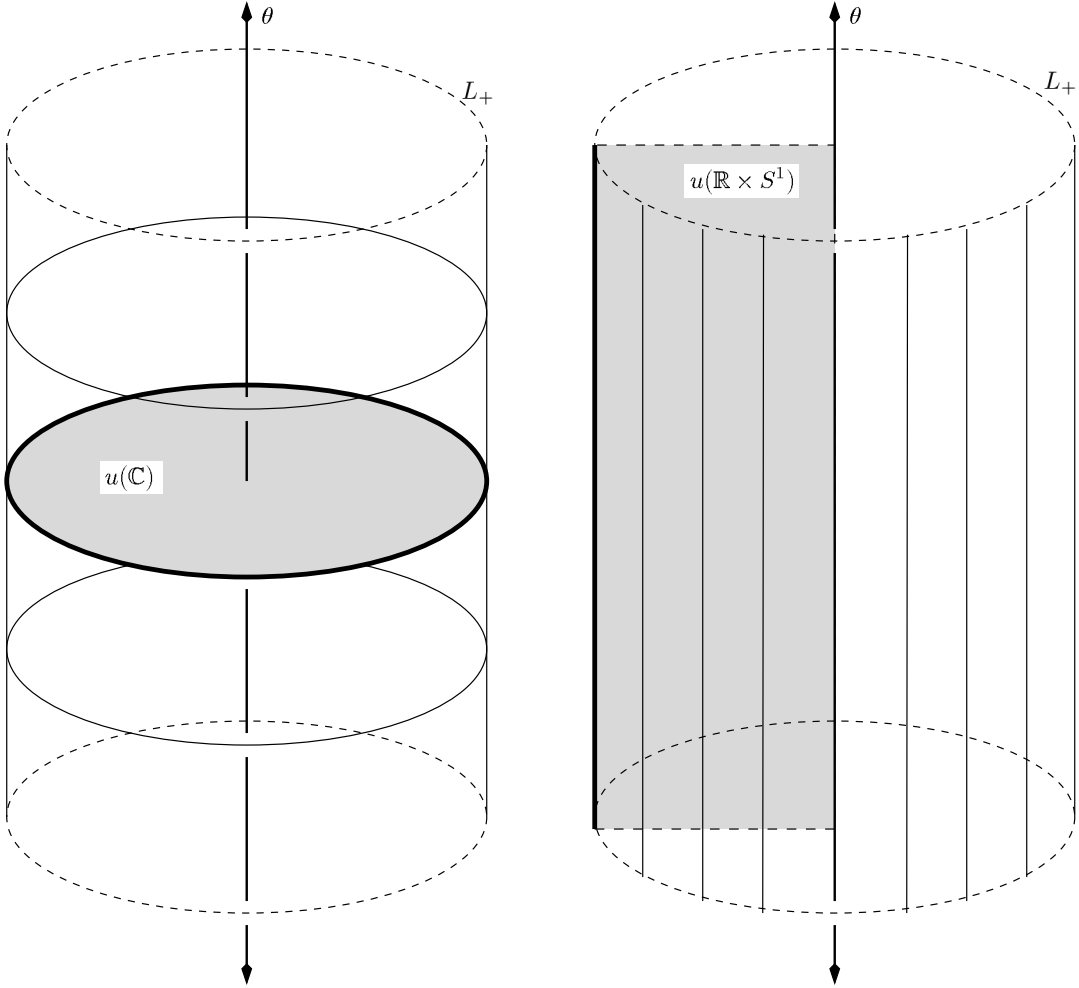

FIGURE 12. Holomorphic curves inside the innermost torus. If orbits on L_+ have nontrivial ∂_θ component (right), we get finite energy cylinders with a puncture asymptotic to the central axis; else that puncture is removable (left) and we get a finite energy plane.

We now apply these constructions to a contact manifold (M, ξ_K) obtained from (S^3, ξ) by a twist surgery along a knot K . Let $N \subset S^3$ be the corresponding solid torus neighborhood of K , identified with $S^1 \times \overline{B_\epsilon^2(0)}$, and denote by $N' = S^1 \times \overline{B_\epsilon^2(0)} \subset M$ the solid torus that replaces it after surgery; thus $M \setminus N' = S^3 \setminus N$. On N' , ξ_K is the kernel of $\lambda_K = f_K(\rho') d\theta' + g_K(\rho') d\phi'$, which for $\rho \in [\delta, \epsilon]$ is the pull back of $\lambda_1 = f_1(\rho) d\theta + g_1(\rho) d\phi$ on N via the gluing map. Let $\rho_1 \in (\delta, \epsilon)$ be the largest radius for which $g'_1(\rho_1) = 0$, so the Reeb orbits on the torus $L_{\rho_1} := \{\rho = \rho_1\}$ are negatively oriented meridians on N . They are generally not meridians on N' , but will represent the homology class $q\lambda' - n\mu' \in H_1(L_{\rho_1})$, where λ' and μ' are the standard longitude and meridian respectively for N' , and q and n are the

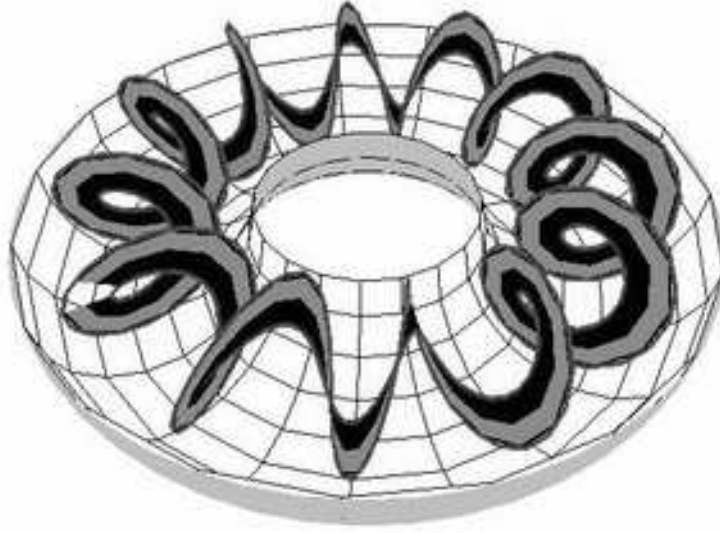

FIGURE 13. A cylinder of type (p, q) in $S^1 \times \mathbb{R}^2$ with $\rho_+ > \rho_- > 0$.

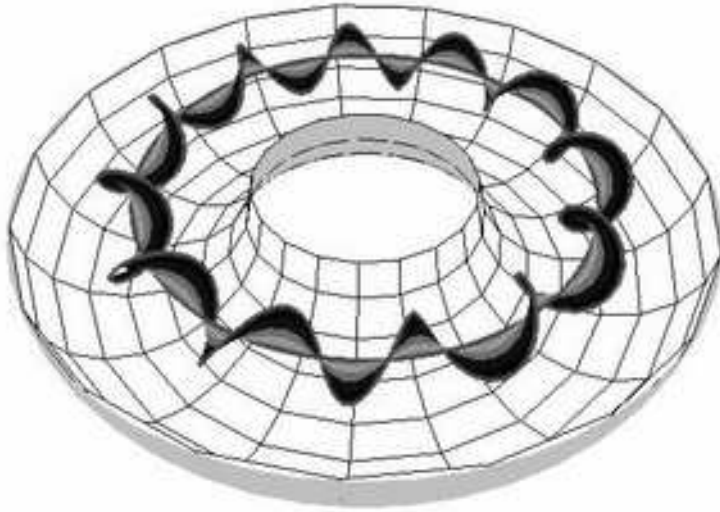

FIGURE 14. A cylinder of type (p, q) in $S^1 \times \mathbb{R}^2$ with $\rho_+ > \rho_- = 0$.

integers appearing in the matrix (4.3). There is then a finite set of radii

$$\rho_1 > \rho_2 > \dots > \rho_s > 0$$

for which the Reeb orbits on L_{ρ_j} represent classes $\pm(q\lambda' - n\mu') \in H_1(L_{\rho_j})$, and we can foliate the regions in between each of these concentric tori by cylinders of type (n, q) . For the region $\{\rho \in (0, \rho_s)\}$, we obtain planes if

$q = 0$, otherwise cylinders asymptotic to the $|q|$ -fold cover of the orbit $S^1 \times \{0\} \subset N'$.

By Prop. 4.4, we're free to assume without loss of generality that q is either 0 or ± 1 , in which case all the orbits in this foliation are simply covered. By conditions (3) and (4) in the proposition, we can also assume the tori L_{ρ_j} are all Morse-Bott, the orbit $S^1 \times \{0\}$ is nondegenerate, all punctures approaching these orbits are positive and the cylinders in the innermost region have index 2.

Before turning to more global considerations, we note another useful local result, which allows a kind of “analytic continuation” for some foliations.

Proposition 4.7. *Let $M = S^1 \times B_\epsilon^2(0)$ with contact form $\lambda = f(\rho) d\theta + g(\rho) d\phi$ and $Jv_1 = \beta(\rho)v_2$ defining the almost complex structure \tilde{J} on $\mathbb{R} \times M$. Now for some $\delta \in (0, \epsilon)$, choose new smooth functions f_1, g_1 and β_1 which match f, g and β for $\rho \in [\delta, \epsilon)$, such that $f_1 g_1' - f_1' g_1 > 0$ for $\rho \in (0, \epsilon)$ and $\beta_1(0) > 0$. These define new data λ_1, J_1 and \tilde{J}_1 , which are smooth on $M \setminus (S^1 \times \{0\})$ but not necessarily at $S^1 \times \{0\}$. Suppose there is a neighborhood \mathcal{U} of $S^1 \times \overline{B_\delta^2(0)}$ in M and a family of \tilde{J} -holomorphic finite energy half-cylinders $\tilde{u} = (a, u) : (-\infty, 0] \times S^1 \rightarrow \mathbb{R} \times M$, all asymptotic to a particular cover of the orbit $P := S^1 \times \{0\}$, and defining a finite energy foliation on \mathcal{U} . Assume moreover that either of the following is true:*

- (1) $f'g'' - f''g' \equiv f_1'g_1'' - f_1''g_1' \equiv 0$.
- (2) $u(s, t) = (\theta(s, t), \rho(s, t), \phi(s, t))$ satisfies $\theta_s \phi_t - \theta_t \phi_s \equiv 0$.

Then for each \tilde{u} there is a unique \tilde{J}_1 -holomorphic half-cylinder $\tilde{u}_1(s, t)$ which matches \tilde{u} on some annulus of the form $[-s_0, 0] \times S^1$. If additionally (f_1, g_1) are C^1 -close to (f, g) then the new maps \tilde{u}_1 are proper and asymptotic to the same orbit as \tilde{u} , and they form an \mathbb{R} -invariant foliation of $\mathbb{R} \times (\mathcal{U} \setminus P)$, projecting to a foliation of $\mathcal{U} \setminus P$.

Proof. Writing the given curves as $\tilde{u}(s, t) = (a(s, t), \theta(s, t), \rho(s, t), \phi(s, t))$, there are constants θ_0, ϕ_0 and fixed integers p and q such that

$$\theta(s, t) \rightarrow \theta_0 + qt, \quad \phi(s, t) \rightarrow \phi_0 - 2\pi pt \quad \text{as } s \rightarrow -\infty,$$

and the functions (a, θ, ρ, ϕ) satisfy (4.8). Combining this with the expressions $a_{st} - a_{ts} = 0$ and $\rho_{st} - \rho_{ts} = 0$ implies

$$(4.14) \quad f\Delta\theta + g\Delta\phi = 0,$$

$$(4.15) \quad f'\Delta\theta + g'\Delta\phi - \frac{1}{\beta}(f'g'' - f''g')(\theta_s\phi_t - \theta_t\phi_s) = 0,$$

where $\Delta := \partial_{ss} + \partial_{tt}$, and f, g and β are understood to depend on $\rho(s, t)$. We now seek a map of the form

$$\tilde{u}_1(s, t) = (a_1(s, t), \theta(s, t), \rho_1(s, t), \phi(s, t))$$

such that $a_1(s, t) = a(s, t)$ and $\rho_1(s, t) = \rho(s, t)$ for $s \geq -s_0$, and solving the corresponding Cauchy-Riemann equations with respect to f_1, g_1 and β_1 .

Since $\theta(s, t)$ and $\phi(s, t)$ are now fixed functions, the new equations for ρ_1 in (4.8) can be interpreted as saying that the graph $\Gamma_{\rho_1} := \{(s, t, \rho_1(s, t))\}$ is tangent to a certain 2-plane distribution in $(-\infty, 0] \times S^1 \times \mathbb{R}$. This distribution turns out to be integrable if and only if

$$(4.16) \quad f_1' \Delta \theta + g_1' \Delta \phi - \frac{1}{\beta_1} (f_1' g_1'' - f_1'' g_1') (\theta_s \phi_t - \theta_t \phi_s) \equiv 0,$$

where the expression is to be understood as a function of three independent variables $(s, t, \rho) \in (-\infty, 0] \times S^1 \times \mathbb{R}$. If it vanishes identically then solutions $\rho_1(s, t)$ exist locally. Assume this for the moment: then choosing $s_0 \in (-\infty, 0)$ such that $\rho(s, t) \geq \delta$ for all $s \geq s_0$, there is a solution $\rho_1(s, t)$ on $(-s_1, 0] \times S^1$ for some $-s_1 < -s_0$, with $\rho_1(s, t) = \rho(s, t)$ for $s \geq -s_0$. For topological reasons, the continued solution is automatically 1-periodic in t . Then for fixed t , the function $s \mapsto \rho_1(s, t)$ satisfies the ODE

$$\frac{d\rho_1}{ds} = \frac{1}{\beta_1(\rho_1)} (f_1'(\rho_1) \theta_t + g_1'(\rho_1) \phi_t),$$

and we see that the solution $\rho_1(s, t)$ extends to $(-\infty, 0] \times S^1$ with

$$\lim_{s \rightarrow -\infty} \rho_1(s, t) = \rho_0,$$

where $\rho_0 \geq 0$ is the largest radius at which $f_1'(\rho_0)/2\pi g_1'(\rho_0) = p/q$, or zero if there is no such radius. The latter is necessarily the case, in particular, if (f_1, g_1) is C^1 -close to (f, g) , because the same argument for \tilde{u} shows that (f, g) cannot admit any radius at which this relation is satisfied.

The remaining two equations in (4.8) specify the gradient of $a_1(s, t)$ in terms of known functions, so solutions exist locally if and only if this gradient is curl-free, which in this case means

$$(4.17) \quad f_1 \Delta \theta + g_1 \Delta \phi \equiv 0$$

for all $(s, t) \in (-\infty, 0] \times S^1$ and $\rho = \rho_1(s, t)$. There is then a unique solution on $(-\infty, 0] \times S^1$ with $a_1(s, t) = a(s, t)$ for all $s \geq s_0$, and another ODE argument establishes that in the case $\rho_0 = 0$, $a(s, t)$ blows up linearly as $s \rightarrow -\infty$.

We claim that the integrability conditions are satisfied whenever either of the two additional assumptions in the Proposition are met. Indeed, if $f'g'' - f''g' \equiv f_1'g_1'' - f_1''g_1' \equiv 0$, then (4.14) and (4.15) give $f\Delta\theta + g\Delta\phi = f'\Delta\theta + g'\Delta\phi = 0$, and since the contact condition requires (f, g) and (f', g') to be linearly independent in \mathbb{R}^2 for all ρ , we conclude that both $\theta(s, t)$ and $\phi(s, t)$ are harmonic. Thus (4.16) and (4.17) are satisfied for all (s, t, ρ) . In the other case, $\theta_s \phi_t - \theta_t \phi_s \equiv 0$ together with (4.14) and (4.15) implies again that θ and ϕ are harmonic, so the same argument applies. \square

4.3. Surgery on a holomorphic open book.

4.3.1. $\mathcal{F}_0 \rightarrow \mathcal{F}_1$: *Stabilizing an open book decomposition.* The global construction begins with a stable foliation of open book type on the tight 3–sphere. Such foliations follow from a general existence result in [HWZ95b], but for our purposes, we can produce one using much less machinery.

Define λ_0 on S^3 as in (4.4): then the Reeb vector field X_0 generates the Hopf fibration. At each $z \in S^3$, $\xi_0 = \ker \lambda_0$ is the unique complex line in $T_z S^3 \subset \mathbb{C}^2$, which therefore admits a natural complex multiplication $i \in \Gamma(\text{End}(\xi))$. Let \tilde{J}_0 be the \mathbb{R} –invariant almost complex structure on $\mathbb{R} \times S^3$ associated to λ_0 and i . Then the diffeomorphism

$$\Phi : (\mathbb{R} \times S^3, \tilde{J}_0) \rightarrow (\mathbb{C}^2 \setminus \{0\}, i) : (a, m) \mapsto e^{2a} m$$

is biholomorphic. For each $\zeta \in \mathbb{C} \setminus \{0\}$, we now define a \tilde{J}_0 –holomorphic plane

$$\tilde{u}_\zeta = (a_\zeta, u_\zeta) : \mathbb{C} \rightarrow \mathbb{R} \times S^3 : z \mapsto \Phi^{-1}(z, \zeta),$$

and for $\zeta = 0$, a cylinder (i.e. punctured plane)

$$\tilde{u}_0 = (a_0, u_0) : \mathbb{C} \setminus \{0\} \rightarrow \mathbb{R} \times S^3 : z \mapsto \Phi^{-1}(z, \zeta).$$

The latter is in fact the trivial cylinder over the Hopf circle

$$P_\infty := \{(e^{2\pi i\theta}, 0) \mid \theta \in S^1\},$$

and the collection of planes $\{\tilde{u}_\zeta\}_{\zeta \in \mathbb{C} \setminus \{0\}}$ is an \mathbb{R} –invariant 2–parameter family of embedded, pairwise disjoint finite energy planes asymptotic to P_∞ . Altogether these define a finite energy foliation \mathcal{F}_0 on (S^3, λ_0, i) . The projection to S^3 is a planar open book decomposition with one binding orbit.

The foliation \mathcal{F}_0 is *not* stable, because the degeneracy of P_∞ gives the planes index 4. We can fix this with a small change to λ_0 near P_∞ , using Prop. 4.7. Indeed, pick any $R \leq 1/\sqrt{2\pi}$ and identify a neighborhood of P_∞ with $S^1 \times B_R^2(0)$ via the embedding

$$(4.18) \quad \psi : S^1 \times B_R^2(0) \hookrightarrow S^3 : (\theta, \rho, \phi) \mapsto e^{2\pi i\theta} \left(\sqrt{1 - 2\pi\rho^2}, e^{i\phi} \sqrt{2\pi\rho} \right).$$

Then $\psi(S^1 \times \{0\}) = P_\infty$ and $\psi^* \lambda_0 = \pi(d\theta + \rho^2 d\phi) = f(\rho) d\theta + g(\rho) d\phi$, where $f(\rho) = \pi$ and $g(\rho) = \pi\rho^2$. Defining the vector fields v_1 and v_2 as in (4.5), the complex multiplication is now specified by $iv_1 = \beta(\rho)v_2$, where

$$\beta(\rho) = \frac{2\pi}{1 - 2\pi\rho^2}.$$

For $\zeta = re^{i\phi_0} \in \mathbb{C} \setminus \{0\}$, we can express the asymptotic behavior of the holomorphic plane $\tilde{u}_\zeta(z) = (a_\zeta(z), u_\zeta(z)) = \left(\frac{1}{2} \ln |(z, \zeta)|, \frac{(z, \zeta)}{|(z, \zeta)|} \right)$ in these coordinates by

$$\begin{aligned} (a(s, t), \theta(s, t), \rho(s, t), \phi(s, t)) &:= (a(e^{-2\pi(s+it)}), \psi^{-1} \circ u_\zeta(e^{-2\pi(s+it)})) \\ &= \left(\frac{1}{4} \ln(e^{-4\pi s} + r^2), -t, \frac{r}{\sqrt{2\pi(e^{-4\pi s} + r^2)}}, \phi_0 + 2\pi t \right), \end{aligned}$$

with $(s, t) \in (-\infty, s_0] \times S^1$ for s_0 sufficiently close to $-\infty$. Observe now that $\theta_s \phi_t - \theta_t \phi_s \equiv 0$, thus by Prop. 4.7, any C^1 -small change in f and g for ρ near 0 admits a new foliation, which is identical to \mathcal{F} outside some neighborhood of P_∞ . In particular, pick $\delta \in (0, R)$ and define

$$\lambda_1 = f_1(\rho) d\theta + g_1(\rho) d\phi = h(\rho) \cdot (\pi d\theta + \pi\rho^2 d\phi)$$

for some function h that satisfies $h(\rho) = 1$ for $\rho \geq \delta$ and is C^1 -close to this on $[0, R)$, and such that $h''(0)$ is small but positive. Then a calculation using Prop. 4.6 shows that for the new contact form, P_∞ is a nondegenerate orbit with $\mu_{\text{CZ}}(P_\infty) = 3$. The new family of planes asymptotic to P_∞ then have index 2 and form a stable foliation \mathcal{F}_1 on (S^3, λ_1, i) .

4.3.2. $\mathcal{F}_1 \rightarrow \mathcal{F}_2$: *Fixing λ and J near a link.* Next, introduce a positively transverse link $K = K_1 \cup \dots \cup K_n \subset S^3$. By Lemma 4.5, there are smooth families $\gamma_j^\tau : S^1 \rightarrow M$ for $\tau \in [0, 1]$ such that $\gamma_j^1(S^1) = K_j$, $\gamma_j^0(t) = (0, e^{2\pi i k_j t})$ for some $k_j \in \mathbb{N}$, and for each fixed $\tau \in (0, 1]$, the maps $\gamma_1^\tau, \dots, \gamma_n^\tau : S^1 \rightarrow M$ are mutually non-intersecting embeddings transverse to ξ . Denote $K_j^\tau = \gamma_j^\tau(S^1)$ and $K^\tau = K_1^\tau \cup \dots \cup K_n^\tau$ for $\tau \in (0, 1]$.

Lemma 4.8. *For $\tau > 0$ sufficiently small, there is a contact form λ_2 with $\ker \lambda_2 = \xi_0$ and the following properties:*

- (i) λ_2 is C^1 -close to λ , and differs from λ only in an arbitrarily small neighborhood of K^τ ,
- (ii) Each of the knots K_j^τ has a tubular neighborhood $N_j \cong S^1 \times B_\epsilon^2(0)$ with coordinates (θ, ρ, ϕ) in which $K_j^\tau = \{\rho = 0\}$ and $\lambda_2 = c(d\theta + \rho^2 d\phi)$ for some constant $c > 0$.

For a complete proof, we refer to [Wen05, Prop. 5.1.3]. The main idea is as follows: observe first that a neighborhood of $P_0 := \{(0, e^{2\pi i \theta}) \mid \theta \in S^1\}$ admits coordinates in which $\lambda_1 = c(d\theta + \rho^2 d\phi)$. These are defined by an embedding $\Psi_0 : S^1 \times B_\epsilon^2(0) \hookrightarrow S^3$ quite similar to (4.18). One can then use a parametrized version of the Moser deformation argument to construct for each K_j a family of contact immersions $\psi_j^\tau : S^1 \times B_\epsilon^2(0) \rightarrow S^3$, which are embeddings near $S^1 \times \{0\}$ for $\tau > 0$, taking $S^1 \times \{0\}$ to K_j^τ , and converge as $\tau \rightarrow 0$ to a k_j -fold cover of Ψ_0 . These define coordinate neighborhoods near K_j^τ in which λ_1 is C^1 -close to something of the form $c(d\theta + \rho^2 d\phi)$.

Let us now redefine notation and call K^τ (for sufficiently small $\tau > 0$) simply K ; we can then assume there is a contact form λ_2 as in Lemma 4.8, taking the form $c(d\theta + \rho^2 d\phi)$ in coordinates near each component of K . Choose a smooth homotopy of contact forms $\{\lambda_r\}_{r \in [1, 2]}$ such that $\ker \lambda_r = \xi_0$ for all r , and each λ_r is C^1 -close to λ_1 , differing from λ_1 only in a tubular neighborhood of K . Observe that the corresponding Reeb vector fields X_r are all C^0 -close to X_1 , and equal to it outside a compact neighborhood of K . We may therefore assume X_r is always transverse to the projection of the foliation \mathcal{F}_1 on $S^3 \setminus P_\infty$. As a consequence we have, without loss of generality:

Proposition 4.9. *Every periodic orbit of X_r that's geometrically distinct from P_∞ is nontrivially linked with P_∞ .*

For $r \in [1, 2]$, choose also a smooth homotopy of admissible complex multiplications $J_r : \xi_0 \rightarrow \xi_0$ such that $J_1 \equiv i$, J_r differs from i only in a neighborhood of K , and J_2 is defined in the coordinates (θ, ρ, ϕ) near each component of K by a relation of the form $J_2 v_1 = \beta(\rho) v_2$, as in §4.2. These choices define a smooth homotopy of almost complex structures \tilde{J}_r . Observe that the binding orbit P_∞ remains a closed orbit with $\mu_{\text{CZ}}(P_\infty) = 3$ for all r . We can now use the machinery of §2 and §3 to show that the foliation \mathcal{F}_1 extends to a continuous family of foliations for $r \in [1, 2]$.

Proposition 4.10. *For each $r \in [1, 2]$, there exists a stable finite energy foliation \mathcal{F}_r of (S^3, λ_r, J_r) which projects to an open book decomposition of S^3 , with binding orbit P_∞ .*

Proof. Denote by \mathcal{M}_r the moduli space of all \tilde{J}_r -holomorphic finite energy surfaces, and define the space

$$\mathcal{M} = \{(r, \tilde{u}) \mid r \in [1, 2], \tilde{u} \in \mathcal{M}_r\}.$$

The latter has a natural topology induced by the same notion of convergence as in \mathcal{M}_r , and there are natural continuous inclusions $\mathcal{M}_r \hookrightarrow \mathcal{M}$ for each r , as well as a natural \mathbb{R} -action on \mathcal{M} . Let \mathcal{M}_1^* denote the connected component of \mathcal{M}_1 that contains the planes in the foliation \mathcal{F}_1 , let \mathcal{M}^* be the corresponding connected component of \mathcal{M} containing \mathcal{M}_1^* , and then define $\mathcal{M}_r^* = \mathcal{M}^* \cap \mathcal{M}_r$.

Combining Theorems 2.6, 2.7 and 2.8, we see that for every $(r, \tilde{u}) \in \mathcal{M}^*$, $\tilde{u} = (a, u)$ is an embedded index 2 plane asymptotic to P_∞ , and $u : \mathbb{C} \rightarrow S^3$ is also embedded. Moreover \tilde{u} is regular, and its neighborhood in \mathcal{M}_r^* foliates neighborhoods of the images of \tilde{u} and u . Clearly then, \mathcal{M}^*/\mathbb{R} is a smooth 2-dimensional manifold, for which the projection map

$$\mathcal{M}^*/\mathbb{R} \rightarrow \mathbb{R} : (r, [\tilde{u}]) \mapsto r$$

is always regular. In light of the linking condition in Prop. 4.9, Theorem 3.4 implies that \mathcal{M}^*/\mathbb{R} is compact. It follows that there is a diffeomorphism

$$\psi : [1, 2] \times \mathcal{M}_1^*/\mathbb{R} \rightarrow \mathcal{M}^*/\mathbb{R}$$

such that $\psi(1, [\tilde{u}]) = [\tilde{u}]$ and for each $r \in [1, 2]$, $\psi(r, \cdot)$ is a diffeomorphism $\mathcal{M}_1^*/\mathbb{R} \rightarrow \mathcal{M}_r^*/\mathbb{R}$. Thus $\mathcal{M}_r^*/\mathbb{R} \cong \mathcal{M}_1^*/\mathbb{R} \cong S^1$. Applying Theorems 2.6 and 2.8 again, we see that any two elements of $\mathcal{M}_r^*/\mathbb{R}$ are either identical or have disjoint images in S^3 . Moreover, if $\mathcal{U}_r \subset S^3 \setminus P_\infty$ is the set of points contained in the image of any curve $[\tilde{u}] \in \mathcal{M}_r^*/\mathbb{R}$, then Theorems 2.6 and 3.4 together imply that \mathcal{U}_r is open and closed, so $\mathcal{U}_r = S^3 \setminus P_\infty$. The collection of curves \mathcal{M}_r^* , together with the trivial cylinder over P_∞ , therefore form a stable finite energy foliation of (S^3, λ_r, J_r) . \square

4.3.3. $\mathcal{F}_2 \rightarrow \mathcal{F}_3$: *Cutting out disks*. For the remainder of §4.3, we impose the following restrictive assumption:

Assumption 4.11. *For each component $K_j \subset K$, $\text{lk}(K_j, P_\infty) = 1$.*

This is needed for technical reasons in the arguments that follow, but will be removed in §4.4 by a branched covering argument.

By the above results, we have a stable foliation \mathcal{F}_2 of (S^3, λ_2, J_2) , transverse to a link $K = K_1 \cup \dots \cup K_m$ whose components have disjoint tubular neighborhoods $N_j \cong S^1 \times B_\epsilon^2(0)$ on which $\lambda_2 = c_j(d\theta + \rho^2 d\phi)$ and J_2 has the form $J_2 v_1 = \beta_j(\rho)v_2$. The Reeb vector field on N_j is $X_2 = \frac{1}{c_j}\partial_\theta$. Pick $\delta \in (0, \epsilon)$ and let $N_j^\delta = \{\rho \leq \delta\} \subset N_j$, with $L_j := \partial N_j^\delta$. Observe that since L_j is foliated by Reeb orbits, which are necessarily transverse to the leaves of \mathcal{F}_2 , L_j is also transverse to these leaves.

We will now replace the planes in \mathcal{F}_2 with solutions to a boundary value problem, having boundary mapped to the tori L_j . For this it is necessary to throw out all except one of the curves in \mathcal{F}_2 ; we will be able to reconstruct a foliation afterwards. Therefore, pick any finite energy plane $\tilde{u} = (a, u) : \mathbb{C} \rightarrow \mathbb{R} \times S^3$ which parametrizes a leaf of \mathcal{F}_2 , and define the set of m disjoint open disks

$$\mathcal{D}_1 \cup \dots \cup \mathcal{D}_m \subset \mathbb{C}$$

by $\mathcal{D}_j = u^{-1}(\text{int } N_j^\delta)$. Then

$$(\Sigma, j) := (S^2 \setminus (\mathcal{D}_1 \cup \dots \cup \mathcal{D}_m), i)$$

is a compact Riemann surface with boundary

$$\partial\Sigma = \gamma_1 \cup \dots \cup \gamma_m,$$

where $\gamma_j := -\partial\overline{\mathcal{D}_j}$, and we have $u(\gamma_j) \subset L_j$. Let $\dot{\Sigma} = \Sigma \setminus \{\infty\}$. Observe that due to Assumption 4.11, each torus L_j meets the image of a *unique* component γ_j under u . Then since each Reeb orbit on L_j has a single transverse intersection with $u(\gamma_j)$, there are unique smooth functions $g_j : L_j \rightarrow \mathbb{R}$ such that $dg_j(X_2) \equiv 0$ and $a(z) = g_j(u(z))$ for all $z \in \gamma_j$. Thus \tilde{u}_j satisfies the totally real boundary condition

$$\tilde{u}(\gamma_j) \subset \tilde{L}_j := \{(g_j(x), x) \in \mathbb{R} \times S^3 \mid x \in L_j\}.$$

This boundary condition is not Lagrangian, so it does not naturally give rise to any obvious energy bounds.³ However, the fact that $dg_j(X_2) \equiv 0$ will allow us to identify each \tilde{L}_j with a Lagrangian torus in the symplectization of S^3 with a *non-contact* stable Hamiltonian structure. This is why Assumption 4.11 is necessary.

Proposition 4.12. *Suppose M is an oriented 3-manifold with positive contact form λ and Reeb vector field X , whose flow is globally defined, and J is an admissible complex multiplication on $\xi = \ker \lambda$ which is preserved*

³It is shown in [Wen05] that one can choose a new definition of energy so that suitable bounds are satisfied and the compactness argument goes through. Here we follow an alternative and somewhat simpler approach.

by the Reeb flow. Denote by \tilde{J} the associated almost complex structure on $\mathbb{R} \times M$, and define an \mathbb{R} -equivariant diffeomorphism by

$$(4.19) \quad \Psi : \mathbb{R} \times M \rightarrow \mathbb{R} \times M : (a, m) \mapsto (a + F(m), m)$$

for some smooth function $F : M \rightarrow \mathbb{R}$ that satisfies $dF(X) \equiv 0$. Then if $\xi' \subset TM$ is the unique 2-plane distribution in $TM = T(\{0\} \times M) \subset T(\mathbb{R} \times M)$ which is preserved by $\Psi_*\tilde{J}$, and $J' := \Psi_*\tilde{J}|_{\xi'} : \xi' \rightarrow \xi'$, the data

$$\mathcal{H}' := (\xi', X, d\lambda, J')$$

define a stable Hamiltonian structure on M , for which the associated almost complex structure is precisely $\Psi_*\tilde{J}$.

Proof. Denoting by $\pi : TM \rightarrow \xi$ the projection along X , define a 1-form

$$\lambda' = \lambda - dF \circ J \circ \pi$$

and let $\xi' = \ker \lambda'$ (we're not assuming this is the same ξ' defined in the statement above). Clearly $\lambda'(X) \equiv 1$, and we claim that also $d\lambda'(X, \cdot) \equiv 0$. Since $L_X \lambda' = d\iota_X \lambda' + \iota_X d\lambda' = \iota_X d\lambda'$, this is equivalent to the statement that ξ' is preserved by the flow of X . Denote this flow by $\varphi^t : M \rightarrow M$ and observe that $\varphi_*^t X \equiv X$ for all t , and by assumption similarly $F \circ \varphi^t \equiv F$ and $\varphi_*^t J \equiv J$. For $m \in M$, any $v \in \xi'_m$ can be written as $v = [dF(m)J\hat{v}]X(m) + \hat{v}$ where $\hat{v} := \pi v \in \xi_m$. Then

$$\begin{aligned} \varphi_*^t v &= [dF(m)J\hat{v}]X(\varphi^t(m)) + \varphi_*^t \hat{v} \\ &= [d(F \circ \varphi^t)(m)J\hat{v}]X(\varphi^t(m)) + \varphi_*^t \hat{v} \\ &= [dF(\varphi^t(m)) \cdot \varphi_*^t(J\hat{v})]X(\varphi^t(m)) + \varphi_*^t \hat{v} \\ &= [dF(\varphi^t(m)) \cdot J(\varphi_*^t \hat{v})]X(\varphi^t(m)) + \varphi_*^t \hat{v} \in \xi'_{\varphi^t(m)}, \end{aligned}$$

proving the claim.

Now observe $d\lambda(X, \cdot) \equiv 0$, and since ξ' is transverse to X , $d\lambda$ is non-degenerate on ξ' and provides a suitable taming form for any complex multiplication $J' : \xi' \rightarrow \xi'$ with the correct orientation. We show next that ξ' is in fact the unique distribution preserved by $\Psi_*\tilde{J}$. Indeed, for $v = [dF(m)J\hat{v}]X(m) + \hat{v} \in \xi'_m$, we have

$$\begin{aligned} (\Psi_*\tilde{J})v &= T\Psi \circ \tilde{J} \circ T\Psi^{-1}([dF(m)J\hat{v}]X(m) + \hat{v}) \\ &= T\Psi \circ \tilde{J}([dF(m)J\hat{v}]X(m) - [dF(m)\hat{v}]\partial_a + \hat{v}) \\ &= T\Psi(-[dF(m)J\hat{v}]\partial_a - [dF(m)\hat{v}]X(m) + J\hat{v}) \\ &= -[dF(m)J\hat{v}]\partial_a - [dF(m)\hat{v}]X(m) + [dF(m)J\hat{v}]\partial_a + J\hat{v} \\ &= -[dF(m)\hat{v}]X(m) + J\hat{v} \\ &= [dF(m)J(J\hat{v})]X(m) + J\hat{v} \in \xi'_m, \end{aligned}$$

thus $\Psi_*\tilde{J}$ restricts on ξ' to the unique map $J' : \xi' \rightarrow \xi'$ such that $J \circ \pi|_{\xi'} \equiv \pi \circ J'$. Finally, observe that $\Psi_*\tilde{J}$ is clearly \mathbb{R} -invariant, and since $T\Psi^{-1}$

and $T\Psi$ each preserve both ∂_a and X ,

$$(\Psi_*\tilde{J})\partial_a = T\Psi \circ \tilde{J} \circ T\Psi^{-1}(\partial_a) = X.$$

□

Remark 4.13. There is an obvious smooth homotopy between the two stable Hamiltonian structures $\mathcal{H}_0 := (\xi, X, d\lambda, J)$ and $\mathcal{H}_1 := (\xi', X, d\lambda, J')$: just define $\mathcal{H}_\tau = (\xi_\tau, X, d\lambda, J_\tau)$ for $\tau \in [0, 1]$ by the same trick, but using the functions $F_\tau := \tau F : M \rightarrow \mathbb{R}$.

Remark 4.14. Finding nontrivial examples of the situation in Prop. 4.12 requires very precise knowledge of the Reeb dynamics. One interesting example is the case where M is a principal S^1 -bundle over a Riemann surface with compatible symplectic structure, and the fibers are generated by X (cf. [BEH⁺03, Example 2.2]). Then the choice of F determines ξ' as a principal connection on this bundle.

We apply the above idea as follows. Pick a smooth function $F : S^3 \rightarrow \mathbb{R}$ supported in $N_1 \cup \dots \cup N_m$, such that $dF(X_2) \equiv 0$ and $F(x) = -g_j(x)$ for all $x \in L_j$. Then the diffeomorphism (4.19) satisfies

$$\Psi(\tilde{L}_j) = \{0\} \times L_j,$$

and there is a stable Hamiltonian structure $\mathcal{H}_3 = (\xi'_2, X_2, d\lambda_2, J'_2)$ with associated almost complex structure \tilde{J}_3 such that

$$\tilde{v} = (b, v) := \Psi \circ \tilde{u} : \dot{\Sigma} \rightarrow \mathbb{R} \times S^3$$

is \tilde{J}_3 -holomorphic and satisfies the Lagrangian boundary condition $\tilde{v}(\gamma_j) \subset \{0\} \times L_j$. Thus writing $\Lambda = (\{0\} \times L_1, \dots, \{0\} \times L_m)$, we have $\tilde{v} \in \mathcal{M}_{\mathcal{H}_3, \Lambda}$; in fact \tilde{v} satisfies the same assumptions as the sequence in our main compactness theorem, so Lemma 3.2 implies $\text{ind}(\tilde{v}) = 2$. Then by Theorem 2.6, the connected component $\mathcal{M}_3^* \subset \mathcal{M}_{\mathcal{H}_3, \Lambda}$ containing \tilde{v} is a smooth 2-manifold with free and proper \mathbb{R} -action, so $\mathcal{M}_3^*/\mathbb{R}$ is a smooth 1-manifold, and Theorem 3.4 implies it is compact, i.e. it is diffeomorphic to S^1 . Arguing again as in Prop. 4.10, we find that the curves in \mathcal{M}_3^* form an \mathbb{R} -invariant foliation \mathcal{F}_3 of $\mathbb{R} \times (M \setminus P_\infty)$, where

$$M := S^3 \setminus \text{int}(N_1^\delta \cup \dots \cup N_m^\delta).$$

It projects to a smooth foliation of $M \setminus P_\infty$ by an S^1 -parametrized family of leaves asymptotic to P_∞ and transverse to $\partial M = L_1 \cup \dots \cup L_m$.

Definition 4.15. A foliation with the properties named above is called a *stable holomorphic open book decomposition with boundary*.

4.3.4. $\mathcal{F}_3 \rightarrow \mathcal{F}_4$: *Twisting.* It follows from Remark 4.13 that there is a smooth homotopy of stable Hamiltonian structures \mathcal{H}_r for $r \in [3, 7/2]$, deforming \mathcal{H}_3 back to the original contact data $\mathcal{H}_{7/2} := (\xi_2, X_2, d\lambda_2, J_2)$. Finally, continue this homotopy for $r \in [7/2, 4]$ by choosing a smooth family of contact forms λ_r on M such that

- (1) $\lambda_r \equiv \lambda_2$ outside coordinate neighborhoods of the tori L_j .
- (2) In a coordinate neighborhood near L_j , $\lambda_r = f_r(\rho) d\theta + g_r(\rho) d\phi$ where $g'_r(\rho) > 0$ for all $r < 4$ and $\rho \geq \delta$, but $g'_4(\delta) = 0$.
- (3) f_4 and g_4 extend for ρ in some open neighborhood of δ such that $g''_4(\delta) > 0$ and $f'_4(\delta) > 0$.

These conditions guarantee that all closed Reeb orbits for $r < 4$ are non-trivially linked with P_∞ , and this remains true at $r = 4$ in $\text{int } M$, but the boundary components L_j then become Morse-Bott tori with closed orbits forming negatively oriented meridians. Notice that no such homotopy of contact forms exists globally on S^3 ; this is why we introduced the boundary condition, to remove the interiors of N_j^δ from the picture.

For any $r_0 \in (3, 4)$, we can apply the arguments of Prop. 4.10 and find a continuous family \mathcal{F}_r of stable holomorphic open book decompositions with boundary for $r \in [3, r_0]$. Then taking $r \rightarrow 4$, the degeneration theorem 3.5 gives limits in the form of finite energy surfaces without boundary, having $m + 1$ positive punctures asymptotic to P_∞ and the simply covered Morse-Bott orbits on $N_1^\delta, \dots, N_m^\delta$. In particular, for any $m \in M \setminus (P_\infty \cup \partial M)$, there exists such a curve $\tilde{v}_\infty = (b_\infty, v_\infty)$ with m in the image of v_∞ : it is obtained by taking sequences of corresponding curves in \mathcal{F}_r passing through m and letting r approach 4. By positivity of intersections, the limit curves are also embedded, and any pair of them has projections that are either identical or disjoint in M . Finally, a simple computation using (1.6) and Lemma 2.5 shows that these curves have index 2. They therefore constitute a stable finite energy foliation of Morse-Bott type on the manifold with boundary M . This, together with the constructions in §4.2, proves the main result for any situation in which Assumption 4.11 is satisfied.

4.4. Lifting to general closed braids. We now complete the proof of Theorem 1.1 by constructing foliations in cases where Assumption 4.11 does not hold. The idea is to define a branched cover over S^3 so that the assumption does hold on the cover, thus the previous arguments produce a foliation, which we will then show has a well defined projection.

By way of preparation, define the usual cylindrical coordinates (θ, ρ, ϕ) on $M := S^1 \times B_\epsilon^2(0)$, pick $n \in \mathbb{N}$ and consider the map

$$(4.20) \quad p : S^1 \times B_\epsilon^2(0) \rightarrow S^1 \times B_\epsilon^2(0) : (\theta, \rho, \phi) \mapsto (\theta, \rho, n\phi).$$

Writing $P := S^1 \times \{0\}$, this map is smooth on $M \setminus P$ and continuous everywhere. Suppose M is endowed with a smooth contact form of type $\lambda = f(\rho) d\theta + g(\rho) d\phi$ and admissible complex multiplication defined by $Jv_1 = \beta(\rho)v_2$ as in §4.2. Then on $M \setminus P$, λ pulls back to another contact form

$$(4.21) \quad \lambda^{(n)} := p^*\lambda = f_n(\rho) d\theta + g_n(\rho) d\phi = f(\rho) d\theta + ng(\rho) d\phi,$$

which extends smoothly to P . In fact, let Φ_0 be the trivialization of $\xi = \ker \lambda$ along P defined by these coordinates, and suppose P is a non-degenerate Reeb orbit for λ with $\mu_{\text{CZ}}^{\Phi_0}(P) = 1$. From Prop. 4.6, this means

$-f''(0)/2\pi g''(0) \in (0, 1)$, and thus the same is true of $-f_n''(0)/2\pi g_n''(0)$, so P also has $\mu_{\text{CZ}}^{\Phi_0}(P) = 1$ with respect to the extended contact form $\lambda^{(n)}$. Writing our standard symplectic frame on $\xi^{(n)} = \ker \lambda^{(n)}$ as $(v_1^{(n)}, v_2^{(n)})$, the complex multiplication J also pulls back on $M \setminus P$ to $J^{(n)} = p^* J$, satisfying $J^{(n)} v_1^{(n)} = \beta_n(\rho) v_2^{(n)}$ where $\beta_n(\rho) = \beta(\rho)$. It turns out that $J^{(n)}$ does *not* have a smooth extension over P , but this will be only a minor irritation in the following.

If Assumption 4.11 does not hold, choose n to be the least common multiple of all the linking numbers $\text{lk}(K_j, P_\infty)$, and define an n -fold branched cover of S^3 as follows. By the results of §4.3.2, there is a contact form λ_2 and complex multiplication J_2 , both of which take the usual simple forms in the neighborhoods N_j of K_j , and (S^3, λ_2, J_2) admits a stable finite energy foliation \mathcal{F}_2 which projects to an open book decomposition of S^3 with binding orbit P_∞ . Denoting $E := S^3 \setminus P_\infty$, this open book defines a fibration $E \rightarrow S^1$, and there is a natural n -fold covering map $p : E^{(n)} \rightarrow E$ and smooth fibration $E^{(n)} \rightarrow S^1$ such that $p(E_\tau^{(n)}) = E_{n\tau}$ for each $\tau \in S^1$. Let $\psi : E^{(n)} \rightarrow E^{(n)}$ be the deck transformation which maps

$$E_\tau^{(n)} \rightarrow E_{\tau + \frac{1}{n}}^{(n)};$$

then every deck transformation is of the form ψ^k for $k \in \mathbb{Z}_n$.

In order to compactify $E^{(n)}$, we shall modify this construction carefully near P_∞ . Recall from (4.18) that a neighborhood of P_∞ admits cylindrical polar coordinates (θ, ρ, ϕ) such that $P_\infty \cong S^1 \times \{0\}$ and λ_2 takes the form

$$\lambda_2 = f(\rho) d\theta + g(\rho) d\phi,$$

where f and g are smooth functions with $f'g'' - f''g' \equiv 0$ near 0. Moreover J_2 is defined in this neighborhood by a relation of the form $J_2 v_1 = \beta(\rho) v_2$. These properties continue to hold if we change the coordinates by any diffeomorphism of the form $(\theta, \rho, \phi) \longmapsto (\theta, \rho, \phi + 2\pi k\theta)$ for $k \in \mathbb{Z}$, thus we can assume without loss of generality that the planes in \mathcal{F}_2 have trivial winding around P_∞ as they approach it in these coordinates. In this case the coordinates define a trivialization Φ_0 in which $\mu_{\text{CZ}}^{\Phi_0}(P_\infty) = 1$. We can now replace \mathcal{F}_2 with another (homotopic) open book decomposition whose pages look like $\{\phi = \text{const}\}$ in a neighborhood of P_∞ . Then applying the covering construction above, $E^{(n)}$ admits a compactification

$$\overline{E}^{(n)} = E^{(n)} \cup P_\infty^{(n)} \cong S^3,$$

where $P_\infty^{(n)}$ is a circle identified with $S^1 \times \{0\}$ in a certain cylindrical coordinate neighborhood, and p maps this neighborhood to a neighborhood of P_∞ via (4.20).

There is thus a continuous extension $p : \overline{E}^{(n)} \rightarrow S^3$, such that $\lambda^{(n)} = p^* \lambda_2$ has the form (4.21) and thus extends smoothly over $\overline{E}^{(n)}$; in fact for this extension, $P_\infty^{(n)}$ is a nondegenerate Reeb orbit with $\mu_{\text{CZ}}^{\Phi_0}(P_\infty^{(n)}) = 1$. The lift $J^{(n)} = p^* J_2$ is uniquely defined over $E^{(n)}$ but singular at $P_\infty^{(n)}$. These

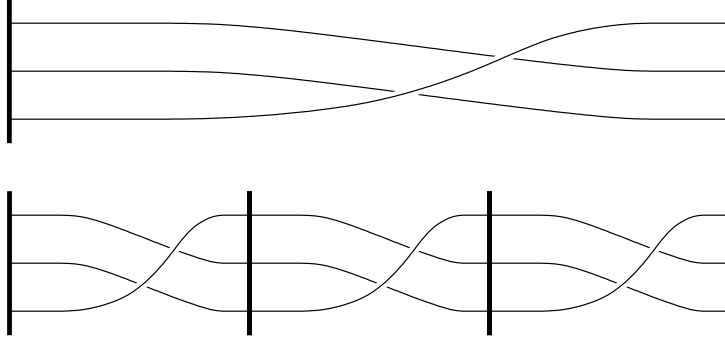

FIGURE 15. The top is a transverse knot K with $\text{lk}(K, P_\infty) = 3$, represented as a closed braid. The bottom is the 3-fold cover $K^{(3)} \subset E^{(3)}$, with three components cyclically permuted by ψ .

are both preserved by the deck transformation ψ , and together they define an almost complex structure $\tilde{J}^{(n)}$ on $\mathbb{R} \times E^{(n)} \subset \mathbb{R} \times \overline{E}^{(n)}$, such that the diffeomorphism

$$\tilde{\psi} : \mathbb{R} \times E^{(n)} \rightarrow \mathbb{R} \times E^{(n)} : (a, m) \mapsto (a, \psi(m))$$

is $\tilde{J}^{(n)}$ -holomorphic. Each leaf $\tilde{u} \in \mathcal{F}_2$ lifts to an embedded $\tilde{J}^{(n)}$ -holomorphic plane $\mathbb{C} \rightarrow \mathbb{R} \times E^{(n)}$, giving a foliation of $E^{(n)}$ by planes asymptotic to $P_\infty^{(n)}$. These can be made into an honest stable foliation by changing $\beta_n(\rho)$ for ρ near 0 so that $J^{(n)}$ becomes smooth. This is possible by Prop. 4.7, because $f'_n g''_n - f''_n g'_n \equiv 0$ in this neighborhood: thus for a suitable smooth choice of $J^{(n)}$, we obtain a stable foliation $\mathcal{F}_2^{(n)}$ which matches the original lift of \mathcal{F}_2 outside some neighborhood of $P_\infty^{(n)}$.

Here is the main point: the link $K \subset E$ lifts to another transverse link $K^{(n)} = p^{-1}(K) \subset E^{(n)}$, and our choice of n guarantees that every connected component $K_j^{(n)} \subset K^{(n)}$ satisfy $\text{lk}(K_j^{(n)}, P_\infty^{(n)}) = 1$ (see Fig. 15). Thus the arguments of §4.3.3 and §4.3.4 produce a stable finite energy foliation \mathcal{F}_4 of Morse-Bott type on $(M^{(n)}, \lambda_4^{(n)}, J_4^{(n)})$, where $M^{(n)}$ is the complement of a neighborhood $N^{(n)}$ of $K^{(n)}$ in $\overline{E}^{(n)} \cong S^3$. We can easily arrange moreover that $N^{(n)}$, $\lambda_4^{(n)}$ and $J_4^{(n)}$ be invariant under the deck transformation ψ , so the diffeomorphisms $\tilde{\psi}^k$ for $k \in \mathbb{Z}_n$ are $\tilde{J}_4^{(n)}$ -holomorphic. This gives rise to a set of n stable foliations $\mathcal{F}_4^k := \tilde{\psi}^k(\mathcal{F}_4)$ for $k \in \mathbb{Z}_n$.

Proposition 4.16. *The foliations \mathcal{F}_4^k are all identical.*

Proof. It suffices to show that for any leaf $\tilde{u} = (a, u) \in \mathcal{F}_4$, the curve

$$\tilde{\psi} \circ \tilde{u} = (a, \psi \circ u) : \dot{\Sigma} \rightarrow \mathbb{R} \times M^{(n)}$$

is also a leaf of the foliation. This follows from positivity of intersections. Indeed, if $\tilde{\psi} \circ \tilde{u}$ is not a leaf, it must have finitely many isolated intersections with some other leaf $\tilde{v} = (b, v) \in \mathcal{F}_4$, and these cannot be eliminated under

homotopies. Thus $\tilde{\psi} \circ \tilde{u}$ also has isolated intersections with \tilde{u} . Now applying an \mathbb{R} -translation, $\tilde{\psi} \circ \tilde{u}$ also intersects $\tilde{u}^\sigma := (a + \sigma, u)$ for all $\sigma \in \mathbb{R}$. Since $a : \dot{\Sigma} \rightarrow \mathbb{R}$ is a proper map, choosing σ large forces these intersections toward the asymptotic limits. But \tilde{u} and $\tilde{\psi} \circ \tilde{u}$ clearly have distinct asymptotic limits, and neither curve intersects the asymptotic limits of the other, thus we have a contradiction. \square

It follows that \mathcal{F}_4 has a well defined projection under p to an \mathbb{R} -invariant foliation of $\mathbb{R} \times S^3$, inducing also a foliation of $S^3 \setminus P_\infty$ by planes asymptotic to P_∞ . The projection of J_4 is singular at P_∞ , but this can again be fixed by an application of Prop. 4.7. The proof of Theorem 1.1 is now complete.

REFERENCES

- [Abb] C. Abbas, *Holomorphic open book decompositions*. In preparation.
- [Ben83] D. Bennequin, *Entrelacements et équations de Pfaff*, Astérisque **107–108** (1983), 87–161; English transl., Russian Math. Surveys **44** (1989), no. 3, 1–65.
- [BEH⁺03] F. Bourgeois, Y. Eliashberg, H. Hofer, K. Wysocki, and E. Zehnder, *Compactness results in symplectic field theory*, Geom. Topol. **7** (2003), 799–888 (electronic).
- [Eli89] Y. Eliashberg, *Classification of overtwisted contact structures on 3-manifolds*, Invent. Math. **98** (1989), no. 3, 623–637.
- [EGH00] Y. Eliashberg, A. Givental, and H. Hofer, *Introduction to symplectic field theory*, Geom. Funct. Anal., Special Volume (2000), 560–673.
- [Etn04] J. B. Etnyre, *Planar open book decompositions and contact structures*, Int. Math. Res. Not. (2004), no. 79, 4255–4267.
- [Gei06] H. Geiges, *Contact geometry*, Handbook of differential geometry. Vol. II, Elsevier/North-Holland, Amsterdam, 2006, pp. 315–382.
- [Gir] E. Giroux. Lecture given at Georgia Topology conference, May 24, 2001, notes available at <http://www.math.uga.edu/~topology/2001/giroux.pdf>.
- [Gir02] ———, *Géométrie de contact: de la dimension trois vers les dimensions supérieures*, Proceedings of the International Congress of Mathematicians, Vol. II (Beijing, 2002), 2002, pp. 405–414.
- [Hof93] H. Hofer, *Pseudoholomorphic curves in symplectizations with applications to the Weinstein conjecture in dimension three*, Invent. Math. **114** (1993), no. 3, 515–563.
- [HWZ95a] H. Hofer, K. Wysocki, and E. Zehnder, *Properties of pseudo-holomorphic curves in symplectisations. II. Embedding controls and algebraic invariants*, Geom. Funct. Anal. **5** (1995), no. 2, 270–328.
- [HWZ95b] ———, *A characterisation of the tight three-sphere*, Duke Math. J. **81** (1995), no. 1, 159–226.
- [HWZ96a] ———, *Properties of pseudoholomorphic curves in symplectisations. I. Asymptotics*, Ann. Inst. H. Poincaré Anal. Non Linéaire **13** (1996), no. 3, 337–379.
- [HWZ96b] ———, *Properties of pseudoholomorphic curves in symplectisations. IV. Asymptotics with degeneracies*, Contact and symplectic geometry (Cambridge, 1994), 1996, pp. 78–117.
- [HWZ99] ———, *Properties of pseudoholomorphic curves in symplectizations. III. Fredholm theory*, Topics in nonlinear analysis, 1999, pp. 381–475.

- [HWZ03] ———, *Finite energy foliations of tight three-spheres and Hamiltonian dynamics*, Ann. of Math. (2) **157** (2003), no. 1, 125–255.
- [HZ94] H. Hofer and E. Zehnder, *Symplectic invariants and Hamiltonian dynamics*, Birkhäuser Verlag, Basel, 1994.
- [Hum97] C. Hummel, *Gromov’s compactness theorem for pseudo-holomorphic curves*, Progress in Mathematics, vol. 151, Birkhäuser Verlag, Basel, 1997.
- [Lic62] W. B. R. Lickorish, *A representation of orientable combinatorial 3-manifolds*, Ann. of Math. (2) **76** (1962), 531–540.
- [Lut71] R. Lutz, *Sur quelques propriétés des formes différentielles en dimension trois*, Ph.D. Thesis, Strasbourg, 1971.
- [Lut77] ———, *Structures de contact sur les fibrés principaux en cercles de dimension trois*, Ann. Inst. Fourier (Grenoble) **27** (1977), no. 3, ix, 1–15 (French, with English summary).
- [Mar71] J. Martinet, *Formes de contact sur les variétés de dimension 3*, Proceedings of Liverpool Singularities Symposium, II (1969/1970), Springer, Berlin, 1971, pp. 142–163. Lecture Notes in Math., Vol. 209 (French).
- [MS04] D. McDuff and D. Salamon, *J-holomorphic curves and symplectic topology*, American Mathematical Society, Providence, RI, 2004.
- [Sav99] N. Saveliev, *Lectures on the topology of 3-manifolds. An introduction to the Casson invariant*, de Gruyter Textbook, Walter de Gruyter & Co., Berlin, 1999.
- [SS92] M. Seppälä and T. Sorvali, *Geometry of Riemann surfaces and Teichmüller spaces*, North-Holland Mathematics Studies, vol. 169, North-Holland Publishing Co., Amsterdam, 1992.
- [Sie05] R. Siefring, *Intersection theory of finite energy surfaces*, Ph.D. Thesis, New York University, 2005.
- [Wal60] A. H. Wallace, *Modifications and cobounding manifolds*, Canad. J. Math. **12** (1960), 503–528.
- [Wen05] C. Wendl, *Finite energy foliations and surgery on transverse links*, Ph.D. Thesis, New York University, 2005.
- [Wen] ———, *Punctured holomorphic curves with boundary in 3-manifolds: Fredholm theory and embeddedness*. In preparation.
- [Ye98] R. Ye, *Filling by holomorphic curves in symplectic 4-manifolds*, Trans. Amer. Math. Soc. **350** (1998), no. 1, 213–250.

DEPARTEMENT MATHEMATIK, HG G38.1, RÄMISTRASSE 101, 8092 ZÜRICH, SWITZERLAND

E-mail address: wendl@math.ethz.ch

URL: <http://www.math.ethz.ch/~wendl/>