

# ON SYMPLECTIC FILLINGS OF SPINAL OPEN BOOK DECOMPOSITIONS II: HOLOMORPHIC CURVES AND CLASSIFICATION

SAMUEL LISI, JEREMY VAN HORN-MORRIS, AND CHRIS WENDL

ABSTRACT. In this second paper of a two-part series, we prove that whenever a contact 3-manifold admits a uniform spinal open book decomposition with planar pages, its (weak, strong and/or exact) symplectic and Stein fillings can be classified up to deformation equivalence in terms of diffeomorphism classes of Lefschetz fibrations. This extends previous results of the third author [Wen10c] to a much wider class of contact manifolds, which we illustrate here by classifying the strong and Stein fillings of all oriented circle bundles with non-tangential  $S^1$ -invariant contact structures. Further results include new vanishing criteria for the ECH contact invariant and algebraic torsion in SFT, classification of fillings for certain non-orientable circle bundles, and a general “symplectic quasiflexibility” result about deformation classes of Stein structures in real dimension four.

## CONTENTS

1. Introduction	2
1.1. Some remarks on the context	4
1.2. Classification of fillings	5
1.3. Weak fillings deform to strong fillings	7
1.4. Symplectic deformation implies Stein deformation	9
1.5. Filling obstructions and contact invariants	10
1.6. Fillings of circle and torus bundles	11
1.7. The non-amenable case and exotic fibers	16
2. Generalities on punctured holomorphic curves	19
2.1. Stable Hamiltonian structures and symplectization ends	19
2.2. Finite energy holomorphic curves	21
2.3. Intersection theory	26
2.4. Automatic transversality and coherent orientations	29
3. A symplectic model of a cylindrical end	35
3.1. Collar neighborhoods and smoothed hypersurfaces	36
3.2. The double completion	38
3.3. Symplectic structure	41
3.4. Stable Hamiltonian structure	43
3.5. Nondegenerate perturbation	46
3.6. The cylindrical end	48

---

2010 *Mathematics Subject Classification*. Primary 32Q65; Secondary 57R17.

S.L. was partially supported by NSF award # 1929176, a SEC travel grant, by a UM CLASRG, F. Bourgeois’s ERC Starting Grant StG-239781-ContactMath, and by V. Colin’s ERC Grant geodycon. C.W. was partially supported during this project by a Humboldt Foundation Postdoctoral Fellowship, a Royal Society University Research Fellowship, and EPSRC grant EP/K011588/1.

3.7.	Almost complex and almost Stein structures	50
3.8.	Holomorphic pages	54
3.9.	Large subdomains with weakly contact boundary	57
4.	Holomorphic curves in spinal open books	61
4.1.	A family of stable Hamiltonian structures	61
4.2.	The unperturbed finite energy foliation	65
4.3.	Perturbation of stable leaves	69
4.4.	Intersection-theoretic properties	71
4.5.	Uniqueness	73
5.	Computations in ECH and SFT	77
6.	Spinal open books $\Rightarrow$ Lefschetz fibrations	81
6.1.	The completed filling and the moduli space	81
6.2.	Generic conditions	88
6.3.	Compactness for nicely embedded curves	91
6.4.	Holomorphic foliations on the completed filling	106
6.5.	The Lefschetz fibration on the filling	114
6.6.	Quasiflexible Stein structures	115
	References	117

## 1. INTRODUCTION

This paper is the sequel to [LVW], which introduced the notion of a spinal open book decomposition

$$\boldsymbol{\pi} := \left( \pi_\Sigma : M_\Sigma \rightarrow \Sigma, \pi_P : M_P \rightarrow S^1, \{m_T\}_{T \subset \partial M} \right)$$

of a 3-manifold  $M$ , a structure that arises naturally whenever  $M$  is the boundary of the total space of a bordered Lefschetz fibration  $\Pi : E \rightarrow \Sigma$  over a compact oriented surface  $\Sigma$  with boundary. A spinal open book splits  $M$  into two (not necessarily connected) pieces  $M_\Sigma \cup M_P$ , the **spine** and **paper** respectively. In the Lefschetz case, when  $M = \partial E$ ,  $M_\Sigma$  is the *horizontal* boundary (the boundaries of all the fibers) and  $M_P$  is the *vertical* boundary (the union of all fibers over the boundary of the base). This means in particular that the ‘‘corner’’  $\partial M_\Sigma = M_\Sigma \cap M_P = \partial M_P$  is a disjoint union of 2-tori, and the two pieces are endowed with smooth fibrations  $\pi_\Sigma : M_\Sigma \rightarrow \Sigma$  and  $\pi_P : M_P \rightarrow S^1$ , where the connected components of the fibers  $\pi_P^{-1}(*) \subset M_P$  are surfaces with boundary called **pages**, the fibers of  $\pi_\Sigma$  are  $S^1$ , and the connected components of its base are surfaces with boundary known as **vertebrae**.

Just as the Lefschetz fibration  $\Pi$  naturally determines a symplectic structure  $\omega$  on  $E$  up to deformation,  $\boldsymbol{\pi}$  determines a contact structure  $\xi$  on  $M$  up to isotopy such that the relationship ‘‘ $\partial\Pi \cong \boldsymbol{\pi}$ ’’ between the two decompositions makes  $(E, \omega)$  a symplectic filling of  $(M, \xi)$ . One of our main goals in the present paper is to invert this relationship and prove a far-reaching generalization of the main result of [Wen10c]: for a particular class of spinal open books  $\boldsymbol{\pi}$  on a closed contact 3-manifold  $(M, \xi)$ , the deformation classes of (weak, strong, exact or Stein/Weinstein) symplectic fillings of  $(M, \xi)$  are in one-to-one correspondence with the diffeomorphism classes of Lefschetz fibrations filling  $\boldsymbol{\pi}$ . In addition to providing a powerful new tool for classifying symplectic fillings, this result reveals the existence of a special class of Stein surfaces, which are *quasiflexible* in the sense that their Stein homotopy types are determined by the (not necessarily exact) deformation classes of their symplectic structures.

*Main ideas and difficulties.* While the proofs in this paper tend to involve a lot of moving parts that take many pages to pin down, the underlying ideas are easy to summarize. In the background are two fundamental geometric phenomena that are quite well known:

- (1) In the tradition of Thurston-Winkelnkemper [Thu76, TW75] and Gompf [GS99, Gom04, Gom05], spinal open books and Lefschetz fibrations uniquely determine contact and symplectic structures respectively up to deformation;
- (2) In the tradition of Gromov and McDuff [Gro85, McD90], certain types of symplectic submanifolds give rise to foliations by  $J$ -holomorphic curves that determine the global structure of a symplectic manifold.

In our setting, the symplectic submanifolds feeding into McDuff’s technique are the pages of a planar spinal open book on the boundary of a symplectic filling, and the resulting  $J$ -holomorphic foliation produces (in favorable cases) a classification of the possible fillings. This idea has appeared before in [Wen10c, NW11, Wen13], whose main results are all special cases of the results of the present paper. However, the level of generality considered here introduces several new difficulties requiring novel solutions, which have contributed substantially to the length of this paper.

One difficulty is that due to the variety of topologies possible in a spinal open book, the moduli spaces of holomorphic curves arising from their pages does not consist exclusively of 0- and 2-dimensional families of embedded curves. It generally also includes 1-dimensional “walls” that must be crossed, as well as multiply covered curves for which transversality is of course a thorny issue. Considerable effort is required in the compactness arguments of §4.5 and §6.3 to either rule out the appearance of such multiple covers or show that when they do arise (which sometimes they must), the necessary transversality results hold anyway. It is a minor miracle that the results work out as nicely as one would hope, and we interpret this as convincing evidence for the naturality of our approach to the filling problem.

A second difficulty concerns the precise type of symplectic fillings that one is attempting to classify: unlike all previous papers on this problem (see §1.1 below), our approach produces a unified framework in which to classify the full spectrum of weak, strong, exact and Weinstein/Stein fillings, each up to the corresponding notion of deformation equivalence. The inclusion of both weak and Weinstein deformation equivalence in this list is one of the most novel details of the present work, and it requires a quite intricate construction (carried out in §3 and §4) of geometric data on the symplectization of a contact manifold supported by a spinal open book.

*Outline of the paper.* The remainder of §1 consists of a quick review of the salient definitions and of statements of the main theorems to be proved in later sections. In particular, the general results on classification of fillings are stated in §1.2–1.4, followed in §1.5 by results on computations of contact invariants. The latter computations parallel the non-fillability results already proved in [LVW]. Section 1.6 then gives a sample application, explaining how the main results imply a classification of the fillings of all partitioned contact  $S^1$ -bundles over oriented surfaces, and §1.7 discusses some slightly subtler examples for which our main classification theorems do not apply but the techniques of this paper still have something to say. Since we will need to make extensive use of  $J$ -holomorphic curves, §2 gives a review of some of the essential technical results—its contents are mostly standard, but it also includes (in §2.4) some useful lemmas about coherent orientations that may not have appeared in writing before. Section 3 continues the development (begun in [LVW, §3]) of a precise model for the half-symplectization of a contact manifold supported by a spinal open book, including

an explicit foliation by  $J$ -holomorphic curves with specific properties that are needed for the proofs of the main results. The analytical properties of this holomorphic foliation are then studied in §4, including existence and uniqueness results that are needed for the computations of algebraic contact invariants carried out in §5. Finally, §6 carries out the holomorphic curve arguments needed to complete the proof that planar spinal open books can be extended to Lefschetz fibrations on fillings.

*Acknowledgments.* This project has taken several years to come to fruition, and we are grateful to many people for valuable conversations along the way, including Denis Auroux, İnanç Baykur, Michael Hutchings, Tom Mark, Patrick Massot, Richard Siefring and Otto van Koert. We would also like to thank the American Institute of Mathematics for bringing the three of us together at key junctures in this project.

**1.1. Some remarks on the context.** Spinal open books provide a unifying perspective on many of the known classification and obstruction results for symplectic fillings in dimension four. The first such results were those of Gromov [Gro85] and Eliashberg [Eli90], which classified the fillings of  $S^3$  and established overtwistedness as a filling obstruction. A short time later, McDuff [McD90] classified the fillings of the universally tight lens spaces  $L(p, 1)$  up to diffeomorphism, a result that was later improved by Hind [Hin03] to a classification up to Stein deformation equivalence. In [Gir94, Eli96], Giroux and Eliashberg found the first examples of contact 3-manifolds that are weakly but not strongly fillable, which are now understood more generally in terms of Giroux torsion [Gay06, GHV, GH, NW11]. Further generalizations of this filling obstruction were introduced by the third author [Wen13] and Latschev [LW11]. Classification results for weak fillings have mostly been limited to cases where the contact manifold is a rational homology sphere (so that weak fillings can be deformed to strong fillings)—the major exception is the planar case, for which [NW11] showed that weak fillings are always deformable to strong fillings without the need for any topological assumption. The techniques of the present paper can be used to provide new and in many cases conceptually simpler proofs of all of the results just mentioned, and we suspect that this is the case for most other previous filling results obtained via holomorphic curve methods, e.g. [OO05, Lis08, Sta15]. In fact, proofs via spinal open books usually lead to strengthened versions of these results, e.g. they always apply to (a subclass of) weak symplectic fillings with potentially nontrivial cohomology at the boundary, in addition to strong and Stein fillings. Moreover, where many of the previous results have achieved classification of fillings up to diffeomorphism, ours also determine the symplectic and Stein deformation classes of fillings—in particular, the Lefschetz fibration approach provides the first systematic technique beyond the isolated results in [Eli90, CE12, Hin00, Hin03] for classifying Stein fillings up to Stein deformation equivalence.

We are also able to recover certain results that were not previously accessible via holomorphic curves, including some of the vanishing results for the Ozsváth-Szabó contact invariant<sup>1</sup> due to Honda-Kazez-Matic [HKM] and Massot [Mas12]. We will see some examples in §1.6 of classification problems that are easily solved using spinal open books but were not previously accessible via any known techniques.

There are still some important results in this subject about which our techniques probably have nothing to say. Prominent examples include Lisca’s filling obstruction in terms of positive scalar curvature [Lis98], Ghiggini’s examples of strongly but not exactly fillable contact

---

<sup>1</sup>Results about the Ozsváth-Szabó contact invariant follow from our results on the ECH contact invariant via the isomorphism [CGHa, CGHb, CGHc] between Heegaard Floer homology and embedded contact homology.

manifolds [Ghi05], and the recent results of Li-Mak-Yasui [LMY17] and Sivek with the second author [SV17] on exact and Stein fillings of unit cotangent bundles over higher genus surfaces. These results all rely in some form on gauge theory, and they seem to represent fundamentally different phenomena from those that are studied in this paper.

**1.2. Classification of fillings.** We will assume in the following that the main definitions from [LVW, §1.1] concerning types of symplectic fillings, symplectic and Stein deformation equivalence, spinal open books, bordered Lefschetz fibrations, and the contact and symplectic structures supported by them are already understood. If  $\Pi : E \rightarrow \Sigma$  is a bordered Lefschetz fibration and  $\pi$  is the induced spinal open book at  $\partial E$ , we will continue to indicate this relationship via the notation

$$\partial\Pi \cong \pi.$$

Let us recall briefly what this means: breaking up  $\partial E$  into its horizontal and vertical boundary  $\partial_h E \cup \partial_v E$ , the paper  $\pi_P : M_P \rightarrow S^1$  is defined from the fibration  $\Pi|_{\partial_v E} : \partial_v E \rightarrow \partial\Sigma$  by identifying each connected component of  $\partial\Sigma$  with  $S^1$  and allowing the fibers of  $\pi_P$  to be disjoint unions of fibers of  $\Pi$ , while the spine  $\pi_\Sigma : M_\Sigma \rightarrow \tilde{\Sigma}$  is defined by factoring  $\Pi|_{\partial_h E} : \partial_h E \rightarrow \Sigma$  through a suitable covering map  $\tilde{\Sigma} \rightarrow \Sigma$  to make the fibers of  $\pi_\Sigma$  connected. We repeat the following slightly technical definitions, since they will play a substantial role in this paper.

**Definition 1.1.** A 3-dimensional spinal open book will be called **partially planar** if its interior contains a page of genus zero. A compact contact 3-manifold  $(M, \xi)$ , possibly with boundary, will be called a **partially planar domain** if  $\xi$  is supported by a partially planar spinal open book. We then refer to any interior connected component of the paper containing planar pages as a **planar piece**.

**Definition 1.2.** Given a spinal open book  $\pi$  with paper  $\pi_P : M_P \rightarrow S^1$  and spine  $\pi_\Sigma : M_\Sigma \rightarrow \Sigma$ , we define the **multiplicity** of  $\pi_P$  at a boundary component  $\gamma \subset \partial\Sigma$  as the degree

$$m_\gamma \in \mathbb{N}$$

of the map

$$(1.1) \quad \gamma \rightarrow S^1 : \phi \mapsto \pi_P(\pi_\Sigma^{-1}(\phi)).$$

Recall that the map (1.1) is well defined due to the condition that boundary components of fibers of  $\pi_P$  are always fibers of  $\pi_\Sigma$ . In general, this map is a finite cover, and  $m_\gamma$  can also be understood as the number of distinct boundary components of a page that lie in the torus  $\pi_\Sigma^{-1}(\gamma)$ .

*Remark 1.3.* In this language, an ordinary open book can be defined as any spinal open book such that the base  $\Sigma$  of the spine is a finite disjoint union of disks and  $m_\gamma = 1$  for every component  $\gamma \subset \partial\Sigma$ . Spinal open books that satisfy the first condition but not the second are examples of *rational* open books in the sense of [BEV12].

**Definition 1.4.** A spinal open book  $\pi$  on a 3-manifold  $M$  will be called **symmetric** if

- (i)  $\partial M = \emptyset$ ;
- (ii) All pages are diffeomorphic;
- (iii) For each of the vertebrae  $\Sigma_1, \dots, \Sigma_r \subset \Sigma$ , there are corresponding numbers  $k_1, \dots, k_r \in \mathbb{N}$  such that every page has exactly  $k_i$  boundary components in  $\pi_\Sigma^{-1}(\partial\Sigma_i)$  for  $i = 1, \dots, r$ .

We shall say that  $\pi$  is **uniform** if, in addition to the above conditions, there exists a fixed compact oriented surface  $\Sigma_0$  whose boundary components correspond bijectively with the connected components of  $M_P$  such that for each  $i = 1, \dots, r$  there exists a  $k_i$ -fold branched cover

$$\Sigma_i \rightarrow \Sigma_0$$

for which the restriction to each connected boundary component  $\gamma \subset \partial\Sigma_i$  is an  $m_\gamma$ -fold cover of the component of  $\partial\Sigma_0$  corresponding to the component of  $M_P$  touching  $\pi_\Sigma^{-1}(\gamma)$ , where  $m_\gamma$  denotes the multiplicity of  $\pi_P$  at  $\gamma$  (see Definition 1.2).

Finally,  $\pi$  is **Lefschetz-amenable** if it is uniform and all branched covers satisfying the above conditions have no branch points.

The symmetry condition played a large role in [LVW] via its presence in the definition of *planar torsion*: essentially, the non-symmetric spinal open books with a planar page are those that can be shown to obstruct symplectic filling by an argument using spine removal surgery and holomorphic spheres.

The significance of the uniformity condition is that every spinal open book that arises as the boundary of a bordered Lefschetz fibration  $\Pi : E \rightarrow \Sigma$  clearly satisfies it; in fact, in this case the required branched covers  $\Sigma_i \rightarrow \Sigma_0$  are honest covering maps, defined as mentioned above by factoring  $\Pi|_{\partial_h E} : \partial_h E \rightarrow \Sigma$  so that the fibers of the spine become connected. It is not true that spinal open books with this property must always be Lefschetz-amenable, but there are many interesting cases (e.g. the oriented circle bundles in §1.6) where amenability is either obvious or can be checked using the Riemann-Hurwitz formula, and Theorem 1.5 below then classifies all fillings in terms of Lefschetz fibrations. In §1.7 we will also discuss some interesting examples that are not Lefschetz-amenable, and say what we can about the implications.

For a given closed contact 3-manifold  $(M, \xi)$ , define the sets

$$\begin{aligned} \Omega_{\text{strong}}(M, \xi) &= \{\text{strong fillings of } (M, \xi)\} / \sim, \\ \Omega_{\text{exact}}(M, \xi) &= \{\text{exact fillings of } (M, \xi)\} / \sim, \\ \Omega_{\text{Stein}}(M, \xi) &= \{\text{Stein fillings of } (M, \xi)\} / \sim, \end{aligned}$$

where the equivalence relation is defined via strong, Liouville or Stein deformation equivalence respectively. Since minimality is preserved under symplectic deformation, we can also define the subset

$$\Omega_{\text{strong}}^{\min}(M, \xi) = \{[(W, \omega)] \in \Omega_{\text{strong}}(M, \xi) \mid (W, \omega) \text{ is minimal}\},$$

and observe that since every Stein filling is exact and every exact filling is minimal, there are canonical maps

$$(1.2) \quad \Omega_{\text{Stein}}(M, \xi) \rightarrow \Omega_{\text{exact}}(M, \xi) \rightarrow \Omega_{\text{strong}}^{\min}(M, \xi).$$

Likewise, for a spinal open book  $\pi$  we define

$$\mathfrak{L}(\pi) = \{\text{bordered Lefschetz fibrations } \Pi : E \rightarrow \Sigma \text{ with } \partial\Pi \cong \pi\} / \sim,$$

where  $\Pi : E \rightarrow \Sigma$  and  $\Pi' : E' \rightarrow \Sigma'$  are considered equivalent if there exist orientation preserving diffeomorphisms  $\varphi : \Sigma \rightarrow \Sigma'$  and  $\Phi : E \rightarrow E'$ , the latter restricting to diffeomorphisms

$\partial_h E \rightarrow \partial_h E'$  and  $\partial_v E \rightarrow \partial_v E'$ , such that  $\Pi' \circ \Phi = \varphi \circ \Pi$ . We also define the subset

$$\mathfrak{L}_A(\boldsymbol{\pi}) = \{[\Pi] \in \mathfrak{L}(\boldsymbol{\pi}) \mid \Pi \text{ is allowable}\},$$

where we recall that  $\Pi$  is called **allowable** if all the irreducible components of its fibers have nonempty boundary. Whenever  $(M, \xi)$  is supported by a uniform spinal open book  $\boldsymbol{\pi}$ , the results of [LVW, §3] yield canonical maps

$$(1.3) \quad \begin{aligned} \mathfrak{L}(\boldsymbol{\pi}) &\rightarrow \Omega_{\text{strong}}(M, \xi), \\ \mathfrak{L}_A(\boldsymbol{\pi}) &\rightarrow \Omega_{\text{Stein}}(M, \xi). \end{aligned}$$

In §6, we will use holomorphic curve technology to prove that the above maps can sometimes be inverted:

**Theorem 1.5.** *Suppose  $(M, \xi)$  is a closed contact 3-manifold that is strongly fillable and contains a compact domain  $M_0 \subset M$ , possibly with boundary, on which  $\xi$  is supported by a partially planar spinal open book  $\boldsymbol{\pi}$ . Then  $M = M_0$  and  $\boldsymbol{\pi}$  is uniform. Moreover, if  $\boldsymbol{\pi}$  is also Lefschetz-amenable, then the canonical maps of (1.2) and (1.3) are all bijections.*

In addition to a classification result, the above implies many non-fillability results, since most spinal open books are not uniform:

**Corollary 1.6.** *If  $(M, \xi)$  is a closed contact 3-manifold containing a partially planar domain that is not uniform, then  $(M, \xi)$  is not strongly fillable.  $\square$*

*Remark 1.7.* As shown in [LVW], partially planar domains never admit non-separating contact embeddings into closed symplectic 4-manifolds, thus the manifolds in Corollary 1.6 can never appear at all as contact-type hypersurfaces in closed symplectic manifolds.

Even in the uniform case, it may happen that a given spinal open book cannot be the boundary of a Lefschetz fibration because of restrictions imposed on its monodromy. This phenomenon is familiar in the case of ordinary open books and has been exploited in [PV10, Pla12, Wan12, KL16, Kal]. We will not consider the factorization problem in much detail here, but will examine the simplest nontrivial case in §1.6, namely when the pages are annuli, so that their mapping class group has a single free generator.

*Remark 1.8.* Theorem 1.5 does not give a classification of fillings for planar spinal open books that are uniform but not Lefschetz-amenable. Under suitable conditions on the monodromy, one can construct a bordered Lefschetz fibration filling a spinal open book of this type whenever there is a choice of surface  $\Sigma_0$  such that the vertebrae admit *unbranched*  $k_i$ -fold covers  $\Sigma_i \rightarrow \Sigma_0$ , but there may be additional fillings not obtained from this construction, corresponding to additional branched covers. Our proof of Theorem 1.5 will in fact produce on any such filling a singular foliation by  $J$ -holomorphic curves which deforms smoothly under symplectic deformations, but in general it will have singularities that cannot be understood purely in terms of Lefschetz fibrations, including a phenomenon that we refer to as *exotic fibers*. See §1.7 for more discussion and some examples.

**1.3. Weak fillings deform to strong fillings.** Under appropriate cohomological conditions, Theorem 1.5 can also be extended to a classification of weak fillings. We recall first the following definition from [LVW].

**Definition 1.9.** Suppose  $(M, \xi)$  is a closed contact 3-manifold and  $\Omega$  is a closed 2-form on  $M$ . A partially planar domain  $M_0$  embedded in  $(M, \xi)$  is called  **$\Omega$ -separating** if it has a planar

piece  $M_0^P \subset \mathring{M}_0$  such that  $\Omega$  is exact on every spinal component touching  $M_0^P$ . It is called **fully separating** if this is true for all closed 2-forms  $\Omega$  on  $M$ .

The condition here depends only on the cohomology class  $[\Omega] \in H_{\text{dR}}^2(M)$  and is vacuous if  $\Omega$  is exact. Recall that every weak filling  $(W, \omega)$  for which  $\omega$  is exact near the boundary can be deformed to a strong filling, cf. [Eli91, Proposition 3.1]. In the special case of disk-like vertebrae, *any* closed 2-form is exact on the spine, thus the following generalizes the theorem of Niederkrüger and the third author [NW11] that weak fillings of planar contact manifolds can (after blowing down) always be deformed to Stein fillings.

**Theorem 1.10.** *Suppose  $(M, \xi)$  is a closed contact 3-manifold,  $\Omega$  is a closed 2-form on  $M$  and  $(M, \xi)$  contains an  $\Omega$ -separating partially planar domain. Then every weak filling  $(W, \omega)$  of  $(M, \xi)$  for which  $[\omega|_{TM}] = [\Omega] \in H_{\text{dR}}^2(M)$  is weakly symplectically deformation equivalent to a strong filling of  $(M, \xi)$ . In particular, if the domain is fully separating then this is true for all weak fillings.*

One general application of this result concerns *rational open books*, which were defined on contact 3-manifolds in [BEV12]: like an open book, it gives a fibration  $M \setminus B \rightarrow S^1$  in the complement of some oriented link  $B \subset M$ , but unlike an ordinary open book, the closures of the pages may be multiply covered at their boundaries. We say that a closed contact 3-manifold  $(M, \xi)$  is **rationally planar** if it is supported by a rational open book with pages of genus zero. The following extends one of the main results of [NW11] from planar to rationally planar contact manifolds.

**Corollary 1.11.** *If  $(M, \xi)$  is a rationally planar contact 3-manifold, then all weak symplectic fillings of  $(M, \xi)$  are symplectically deformation equivalent to strong fillings.*

*Proof.* We note first that using methods from [V07], any rational open book can be modified—without changing the contact structure or the page genus—to one with the property that every boundary component of the closure of a page covers the respective binding component once (though there still may be multiple boundary components covering the same component of the binding). One can see this by presenting a neighborhood of any  $k$ -fold covered binding component as  $\mathbb{D} \times S^1$  with contact form  $d\phi + \rho^2 d\theta$  in coordinates  $\rho e^{i\theta} \in \mathbb{D} \subset \mathbb{C}$  and  $\phi \in S^1 = \mathbb{R}/\mathbb{Z}$ , such that the pages in this region are parametrized by the punctured disks

$$\mathbb{D} \setminus \{0\} \hookrightarrow \mathbb{D} \times S^1 : z \mapsto (z, \arg z^k + \phi)$$

for different choices of constants  $\phi \in S^1$ . (Note that here it is possible for different choices of  $\phi \in S^1$  to produce distinct subsets of the same page.) One can then choose any function  $f : \mathbb{D} \rightarrow \mathbb{C}$  that is  $C^\infty$ -close to  $z \mapsto z^k$  and matches it precisely for  $\rho \geq 1/2$  but has exactly  $k$  simple and positive zeroes, and replace the pages above with

$$\mathbb{D} \setminus f^{-1}(0) \hookrightarrow \mathbb{D} \times S^1 : z \mapsto (z, \arg f(z) + \phi).$$

Each zero of  $f$  now gives rise to a new page boundary component that covers the corresponding component of  $f^{-1}(0) \times S^1 \subset \mathbb{D} \times S^1$  exactly once, and these modified pages are also transverse to the Reeb vector field for the contact form  $d\phi + \rho^2 d\theta$ .

With this modification in place, the resulting rational open book is still planar but can also be interpreted as a spinal open book (see Remark 1.3). The result then follows from Theorem 1.10 since the spine is a union of solid tori, on which all closed 2-forms are exact.  $\square$



*Remark 1.12.* It is not known whether there exist rationally planar contact manifolds which are not planar, though Corollary 1.11 may be interpreted as providing some evidence against this.

**1.4. Symplectic deformation implies Stein deformation.** Another result closely related to Theorem 1.5 concerns the question of to what extent the *symplectic* geometry of a Stein manifold determines its *Stein* geometry. The following two questions express this more precisely.

**Question 1.** *Do there exist two Stein domains that are symplectic deformation equivalent but not Stein deformation equivalent?*

**Question 2.** *Is there a natural class of Stein domains with the property that any two domains in the class are Stein deformation equivalent if and only if they are symplectically deformation equivalent?*

The first question is completely open. For the second, it is known in higher dimensions that two *flexible* Stein structures on a given manifold will always be Stein homotopic whenever they can be related by a symplectic deformation; this follows from an  $h$ -principle for flexible Weinstein structures, [CE12, Chapter 14], and it suffices in this case to know that their underlying almost complex structures are homotopic. We will show however that in real dimension four, there exists a larger class of Stein structures answering Question 2 than what might be suggested by known flexibility results (e.g. for the subcritical case). In the following statement, we say that a Stein domain  $(W, J)$  is **supported by** a certain Lefschetz fibration  $\Pi : E \rightarrow \Sigma$  if  $\Pi$  admits a supported almost Stein structure that is (after smoothing corners) almost Stein deformation equivalent to  $(W, J)$ .<sup>2</sup>

**Theorem 1.13.** *Suppose  $(W, J_0)$  is a Stein domain of real dimension 4, supported by a bordered Lefschetz fibration  $\Pi : E \rightarrow \Sigma$  with fibers of genus 0. Suppose  $J_1$  is another Stein structure on  $W$ , and denote by  $\omega_0$  and  $\omega_1$  the symplectic structures induced by choices of plurisubharmonic functions for  $J_0$  and  $J_1$  respectively. Then  $J_0$  and  $J_1$  are Stein homotopic if and only if  $\omega_0$  and  $\omega_1$  are homotopic through symplectic structures convex at the boundary.*

*Moreover, if  $\Sigma = \mathbb{D}^2$ , then  $J_0$  and  $J_1$  are Stein homotopic if and only if there exist smooth homotopies  $\{\omega_\tau\}_{\tau \in [0,1]}$  of symplectic forms on  $W$  and contact structures  $\{\xi_\tau\}_{\tau \in [0,1]}$  on  $\partial W$  such that  $(W, \omega_\tau)$  is a weak filling of  $(\partial W, \xi_\tau)$  for all  $\tau \in [0, 1]$ .*

This result would be a corollary of Theorems 1.5 and 1.10 if one could always assume that the spinal open book induced on the boundary of a bordered Lefschetz fibration is Lefschetz-amenable, but the latter is false in general (see Example 1.34 for a counterexample). We will prove the theorem in §6.6 by combining the holomorphic curve arguments behind Theorems 1.5 and 1.10 with the criterion established in [LVW, §2.4] for the canonical Stein structure supported by a Lefschetz fibration.

**Example 1.14.** By the main result of [Wen10c], Theorem 1.13 applies to all Stein fillings of planar contact 3-manifolds, which includes all subcritical fillings, but also many critical examples such as the unit disk bundle in  $T^*S^2$ . A further class of non-subcritical examples comes from products  $\Sigma_0 \times \Sigma_1$  of two Riemann surfaces with boundary such that at least one of them has genus zero but neither is a disk; this includes e.g. the unit disk bundle in  $T^*\mathbb{T}^2$ , which (after rounding corners) is a product of two annuli.

<sup>2</sup>For a brief review of almost Stein structures, see Definition 3.1.

*Remark 1.15.* Theorem 1.13 probably also holds under the slightly more general hypothesis that the contact boundary of  $(W, J_0)$  is supported by a planar spinal open book—the latter need not be the boundary of a Lefschetz fibration since it might not be Lefschetz-amenable. Proving the theorem in this generality would require a better geometric understanding of the so-called *exotic* fibers that are possible in non-amenable cases (cf. §1.7).

*Remark 1.16.* If one wants to find examples of Stein surfaces that are symplectically but not Stein deformation equivalent, then Theorem 1.13 and Remark 1.15 suggest searching among Stein surfaces  $(W, J)$  whose contact boundaries  $(M, \xi)$  do not admit supporting spinal open books with planar pages. The main results of this paper and [LVW] provide several mechanisms for recognizing contact 3-manifolds with the latter property, e.g. by [LVW, Corollary 1.30],  $(M, \xi)$  cannot contain a partially planar domain if it arises as a component of a strong symplectic filling with disconnected boundary. Popular examples include the unit disk bundles in  $T^*\Sigma$  for  $\Sigma$  any oriented surface with genus at least two; the resulting unit cotangent bundle is one component of an exact filling with disconnected boundary that was famously constructed by McDuff [McD91].

**1.5. Filling obstructions and contact invariants.** Many special cases of the non-fillability statement in Corollary 1.6 follow already from the results on planar torsion in [LVW], but they can also be derived from computations of contact invariants in embedded contact homology (cf. [Hut10, Wen13]) or symplectic field theory (cf. [EGH00, LW11]). The main invariant we have in mind is the *order of algebraic torsion*, as defined in [LW11]. This is a nonnegative (or possibly infinite) integer extracted from the full symplectic field theory algebra of a contact manifold; it equals zero if and only if the manifold is *algebraically overtwisted* in the sense of [BN10], while positive values can be interpreted as measuring the manifold’s “degree of tightness”. The following result, which provides the main motivation behind the terminology “planar  $k$ -torsion,” is a generalization of [LW11, Theorem 6].<sup>3</sup>

**Theorem 1.17.** *If  $(M, \xi)$  has  $\Omega$ -separating planar  $k$ -torsion for some  $k \geq 0$ , then it also has  $\Omega$ -twisted algebraic  $k$ -torsion.*

Since our contact manifolds  $(M, \xi)$  in this paper are always 3-dimensional, we can also consider the closely related filling obstruction furnished by the *ECH contact invariant*, i.e. the distinguished class in the embedded contact homology of  $(M, \xi)$ , defined by Hutchings (see e.g. [Hut10]). The next theorem is a direct generalization of the vanishing results proved in [Wen13]:

**Theorem 1.18.** *If  $(M, \xi)$  has  $\Omega$ -separating planar  $k$ -torsion for any  $k \geq 0$ , then its ECH contact invariant with twisted coefficients in  $\mathbb{Z}[H_2(M)/\ker \Omega]$  vanishes.*

There is also an algebraic counterpart for the theorem from [LVW] that partially planar domains obstruct semifillings with disconnected boundary: it involves the so-called *U-map* in ECH, which is defined by counting index 2 holomorphic curves through a generic point in the symplectization. This result generalizes the ECH version of a planarity obstruction first established by Ozsváth-Stipsicz-Szabó [OSS05] in Heegaard Floer homology and extended to ECH in [Wen13]:

**Theorem 1.19.** *If  $(M, \xi)$  contains an  $\Omega$ -separating partially planar domain, then for all  $k \in \mathbb{N}$ , the contact invariant in ECH with twisted coefficients in  $\mathbb{Z}[H_2(M)/\ker \Omega]$  is in the image of  $U^k$ .*

<sup>3</sup>See [LVW, §1.3] for the main definitions concerning planar torsion domains.

See §1.6.2 for some sample applications of these theorems, where they are used in particular to prove new vanishing results for contact invariants on circle bundles.

**1.6. Fillings of circle and torus bundles.** In [LVW, §1.4], we exhibited a large class of  $S^1$ -invariant contact structures on circle bundles which are supported by spinal open books with annular pages. We now extend the non-fillability results from that paper to a more comprehensive classification of fillings.

Assume throughout this section that

$$\pi : M \rightarrow B$$

is a smooth fiber bundle whose fibers are diffeomorphic to  $S^1$  and whose total space is a closed, connected and oriented 3-manifold, while the base  $B$  is a closed connected surface that need not necessarily be orientable. Reducing the structure group of the bundle to  $O(2)$  then defines the notion of  $S^1$ -invariant contact structures  $\xi$  on  $M$ , each of which determines a multicurve  $\Gamma \subset B$  by the condition that fibers over  $\Gamma$  are tangent to  $\xi$ . We say in this case that  $\xi$  is **partitioned by**  $\Gamma$ , and it follows that  $B \setminus \Gamma$  must be orientable and  $\Gamma$  satisfies a further technical condition (it “inverts orientations”). Conversely, for any multicurve  $\Gamma \subset B$  satisfying these two conditions, there is a unique isotopy class of  $S^1$ -invariant contact structures partitioned by  $\Gamma$ . We shall denote contact manifolds of this type always by

$$(M, \xi_\Gamma).$$

The existence and uniqueness of  $\xi_\Gamma$  is a famous result of Lutz in the case where  $B$  is orientable [Lut77], and in the general case it was deduced in [LVW] from the existence and uniqueness of contact structures supported by spinal open books. In particular,  $(M, \xi_\Gamma)$  is supported by a spinal open book whose paper is a tubular neighborhood of  $\pi^{-1}(\Gamma)$ , with annular pages, while the vertebrae correspond to the connected components of  $B \setminus \Gamma$ .

*Remark 1.20.* In the case when  $B$  is non-orientable, the total space is nevertheless oriented, and there is still a well-defined Euler number. As it turns out, over a given base  $B$ , these bundles are characterized by this Euler number. Indeed, this can be seen by viewing such fiber bundles  $\pi : M \rightarrow B$  as Seifert fibered spaces with no exceptional fibers. For more details, see the discussion in [Sco83, page 434].

**1.6.1. Classification of fillings.** Whenever  $\pi : M \rightarrow B$  corresponds to a spinal open book that is Lefschetz-amenable, Theorem 1.5 classifies the strong fillings of  $(M, \xi_\Gamma)$  as bordered Lefschetz fibrations with annulus fibers. The amenability condition is trivial to verify when  $B$  is orientable.

**Theorem 1.21.** *Suppose  $\xi_\Gamma$  is an  $S^1$ -invariant contact structure on a circle bundle  $\pi : M \rightarrow B$ , partitioned by a nonempty multicurve  $\Gamma$ , where  $B$  is orientable. Then  $(M, \xi_\Gamma)$  is strongly fillable if and only if  $B \setminus \Gamma$  has two connected components, both of them diffeomorphic to a single surface  $\Sigma$ , and the Euler number  $e(\pi)$  of the bundle satisfies*

$$e(\pi) \geq 0.$$

*Moreover, the Stein, Liouville and minimal strong fillings of  $(M, \xi_\Gamma)$  are all unique up to deformation equivalence and can be characterized via supporting allowable Lefschetz fibrations over  $\Sigma$  with fiber  $[-1, 1] \times S^1$ , which restrict to trivial fibrations on the horizontal boundary and have  $e(\pi)$  singular fibers.*

*Proof.* When  $B$  is orientable,  $\Gamma$  necessarily divides  $B$  into two (each possibly disconnected) components  $B_+$  and  $B_-$ , thus determining similar labels  $M_\Sigma^\pm$  for corresponding components of the spine  $M_\Sigma$ . Every page of  $\pi_P : M_P \rightarrow S^1$  thus has one boundary component touching  $M_\Sigma^+$  and the other touching  $M_\Sigma^-$ , so symmetry of  $\pi$  implies that  $M_\Sigma$  must have exactly two connected components, each touching one boundary component of every page. This implies that each boundary component of the spine has multiplicity 1 in the sense of Definition 1.2. If  $\pi$  is also uniform, then the vertebrae of the two spinal components must also be diffeomorphic, and the Lefschetz-amenability condition is trivially satisfied. It follows that  $B \setminus \Gamma$  has exactly two components and they are diffeomorphic to a fixed surface  $\Sigma$ , and minimal fillings of  $(M, \xi_\Gamma)$  correspond to Lefschetz fibrations over  $\Sigma$  with annulus fibers.

Observe now that any two allowable Lefschetz fibrations over  $\Sigma$  with annulus fibers and with the same number of critical points are symplectic deformation equivalent. Let  $\Pi : E \rightarrow \Sigma$  be such an allowable Lefschetz fibration. Fix a basepoint  $z_0 \in \Sigma$  and choose an orientation-preserving identification of  $\Pi^{-1}(z_0)$  with  $[-1, 1] \times S^1$ . Trivialize the two components of  $\partial E \rightarrow \Sigma$  consistently with this. After choosing a collection of paths in  $\Sigma$  that connect  $z_0$  with the points in  $\partial\Sigma$  that correspond to  $\pi_P^{-1}(1)$ , we obtain a well-defined monodromy map  $[-1, 1] \times S^1 \rightarrow [-1, 1] \times S^1$  for each boundary component of  $\partial\Sigma$ . Notice that by changing the trivialization of  $\partial E \rightarrow \Sigma$ , we may change these monodromies, but their composition remains invariant, and will be isotopic to a  $k$ -fold Dehn twist where  $k$  is the number of singular fibers. In particular, by a suitable choice of trivialization of  $\partial E \rightarrow \Sigma$ , we arrange for the monodromy about each boundary component of  $\partial\Sigma$  to be trivial, except for one, where we have a  $k$ -fold Dehn twist. A computation verifies that  $\partial E$  is then a circle bundle over the doubled surface  $\Sigma \cup_{\partial\Sigma} (-\Sigma)$  with Euler class given by  $k$ . □

*Remark 1.22.* It is possible for the partitioning multicurve  $\Gamma \subset B$  of an  $S^1$ -invariant contact structure to be empty when  $B$  is orientable: this means that  $(M, \xi_\Gamma)$  is a prequantization bundle with its canonical contact structure. In this case Theorem 1.21 does not apply, and in fact, the problem of classifying strong fillings of prequantization bundles is not generally tractable: e.g. whenever  $B$  has genus  $g \geq 2$ , there exists a prequantization bundle  $(M, \xi_\Gamma)$  over  $B$  admitting exact semifillings with disconnected boundary (see [McD91]), from which one can construct an unmanageable multitude of topologically unrelated fillings of  $(M, \xi_\Gamma)$  by attaching concave fillings from [EH02] to the other boundary component.

**Theorem 1.23.** *Suppose  $\xi_\Gamma$  is an  $S^1$ -invariant contact structure on a circle bundle  $\pi : M \rightarrow B$ , partitioned by a nonempty multicurve  $\Gamma$ , where  $B$  is not orientable and  $\Gamma$  has  $k \geq 0$  connected components that are not co-orientable.*

*If  $(M, \xi_\Gamma)$  is strongly fillable, then  $B \setminus \Gamma$  is connected and*

$$k \leq 2(g + 1),$$

*where  $g$  is the genus of  $B \setminus \Gamma$ .*

*Assuming additionally that  $B \setminus \Gamma$  is connected and  $k = 2(g + 1)$ ,  $(M, \xi_\Gamma)$  is strongly fillable if and only if its Euler number (see Remark 1.20) is non-negative. In that case, its Stein, Liouville and minimal strong fillings are unique up to deformation equivalence.*

*Proof.* Assume  $B$  is non-orientable and  $\Gamma$  consists of  $k$  components with nontrivial normal bundle and  $\ell$  components with trivial normal bundle. If  $\pi$  is symmetric, then the spine can have at most two connected components, and it has exactly two only if every page has its two boundary components touching different spinal components, which means  $k = 0$  and the

$\ell$  components of  $\Gamma$  divide  $B$  into two connected components  $B_+$  and  $B_-$ . But since  $\Gamma$  inverts orientations, this would imply that  $B$  is orientable and thus contradicts our assumptions. We conclude that  $B \setminus \Gamma$  is connected and has the homotopy type of a compact oriented surface  $\Sigma$  with some genus  $g \geq 0$  and  $k + 2\ell$  boundary components. The multiplicity of  $\pi_P$  is 2 at the  $k$  boundary components of  $M_\Sigma$  corresponding to curves that are not co-orientable, and 1 at its other  $2\ell$  boundary components. Uniformity of  $\pi$  then means that there exists a double branched cover of  $\Sigma$  over some surface  $\Sigma_0$  of arbitrary genus  $h \geq 0$  with  $k + \ell$  boundary components. By the Riemann-Hurwitz formula, the algebraic count of branch points is

$$-\chi(\Sigma) + 2\chi(\Sigma_0) = -(2 - k - 2\ell - 2g) + 2(2 - k - \ell - 2h) = 2 - k + 2g - 4h \geq 0,$$

hence the required branched cover is possible for any genus  $h \geq 0$  satisfying

$$4h \leq 2(g + 1) - k.$$

If equality is achieved, then the resulting branched cover has no branch points. In particular, this will always be the case if  $k = 2(g + 1)$ , so the case of  $k = 2(g + 1)$  is Lefschetz-amenable.

By Theorem 1.5, it follows that, if  $k = 2(g + 1)$ , any filling of  $(M, \xi_\Gamma)$  is (up to deformation) realized as a Lefschetz fibration  $\Pi: E \rightarrow \Sigma_0$  with annular fibers where  $\Sigma_0$  has genus zero and  $k + \ell$  boundary components. Furthermore,  $\partial\Pi$  gives the spinal open book decompositions described by  $B, \Gamma$ .

Notice now that  $k = 2(g + 1)$  is even. We may thus decompose  $\Sigma_0$  into a collection of pairs of pants, of annuli and of disks with the property that each subsurface has an even number of boundary components among the  $k$  boundary components of  $\Sigma_0$  that correspond to the non-co-orientable curves in  $\Sigma = B \setminus \Gamma$ , and all Lefschetz critical values are contained in the disks. From this, the restrictions of the fibration to the pairs of pants and annuli are smooth symplectic fibrations with annulus fibers. Furthermore, if the base is the annulus, they will either be a trivial fibration or the fattened mapping torus of the “flip” (map of the annulus by  $(r, \theta) \mapsto (-r, -\theta)$ ). If the base is a pair-of-pants, the fibration will be one of these two models with a fiber deleted.

Now, choose a framing of the spinal open book decomposition  $\pi$ , i.e. a trivialization of the circle bundle  $\pi_\Sigma: M_\Sigma \rightarrow \Sigma$ . This then allows us to define the monodromy of each component of the paper. Notice that the “flip” map and a Dehn twist commute (up to homotopy). From this, we observe that a change in framing has no effect on the composition of all the monodromies. A computation now shows this composition must have the number of Dehn twists given by the Euler number of  $\pi: M \rightarrow B$ .

Extending the framing of the spinal open book to the Lefschetz fibration  $\Pi$ , we obtain that the net monodromy around the vertical boundary is some number of Dehn twists, given by precisely the number of critical fibers. □

1.6.2. *Vanishing results for contact invariants.* In [LVW] we gave a characterization of which partitioned  $S^1$ -invariant contact circle bundles have planar 1-torsion. Combining that result with Theorems 1.17 and 1.18 gives the following statement, generalizing a result for trivial circle bundles that was proved in [LW11]:

**Corollary 1.24.** *Suppose  $\xi_\Gamma$  is an  $S^1$ -invariant contact structure on a circle bundle  $\pi: M \rightarrow B$ , partitioned by a nonempty multicurve  $\Gamma$ , and that either of the following holds:*

- (i)  $B \setminus \Gamma$  has at least three connected components;
- (ii)  $B \setminus \Gamma$  is disconnected and  $B$  is non-orientable.

Then  $(M, \xi_\Gamma)$  has (untwisted) algebraic 1-torsion and vanishing (untwisted) ECH contact invariant.  $\square$

When the bundle is trivial, we can use some input from Seiberg-Witten theory to obtain a stronger result for the ECH contact invariant:

**Theorem 1.25.** *Suppose  $\pi : M \rightarrow B$  is a trivial circle bundle and  $\xi_\Gamma$  is an  $S^1$ -invariant contact structure partitioned by a multicurve  $\Gamma \subset B$ . Then  $(M, \xi_\Gamma)$  has nonzero (untwisted) ECH contact invariant if and only if  $\Gamma$  divides  $B$  into exactly two connected components that are diffeomorphic to each other.*

*Proof.* When  $B = \Sigma_+ \cup_\Gamma \Sigma_-$  for a connected surface  $\Sigma_+ \cong \Sigma_- \cong \Sigma$ , the ECH contact invariant of  $(B \times S^1, \xi_\Gamma)$  is nonzero because it has a strong filling, namely the trivial annulus fibration over  $\Sigma$ . Excluding the cases covered by Corollary 1.24, it then remains to prove that the ECH contact invariant vanishes whenever  $B \setminus \Gamma$  has two connected components  $\Sigma_+$  and  $\Sigma_-$  with differing genus.

This follows from [Wen13] if either component has genus zero, but if both have positive genus, then we must instead appeal to Seiberg-Witten theory. Denote the contact invariant by  $[\emptyset]$ ; it is an element of  $\text{ECH}_*(B \times S^1, \xi_\Gamma, 0)$ , the embedded contact homology of  $(B \times S^1, \xi_\Gamma)$  generated by orbit sets with total homology class  $0 \in H_1(B \times S^1)$ . By Theorem 1.19, there exists for every  $k \in \mathbb{N}$  an element  $\gamma_k \in \text{ECH}_*(B \times S^1, \xi_\Gamma, 0)$  such that  $U^k \gamma_k = [\emptyset]$ . Now observe that if  $\Sigma_+ \not\cong \Sigma_-$ , then  $c_1(\xi_\Gamma) \in H^2(B \times S^1)$  is not torsion; indeed,

$$c_1(\xi_\Gamma) = (\chi(\Sigma_+) - \chi(\Sigma_-)) \text{PD}[\{*\} \times S^1].$$

By the work of Taubes [Tau10],  $\text{ECH}_*(B \times S^1, \xi_\Gamma, 0)$  is isomorphic to a certain version of the monopole Floer homology of Kronheimer and Mrowka [KM07] for the  $\text{Spin}^c$ -structure determined by the homotopy class of  $\xi_\Gamma$ . The first Chern class of this  $\text{Spin}^c$ -structure is precisely  $c_1(\xi_\Gamma)$  and is thus not torsion, so by results of Kronheimer and Mrowka [KM07], the monopole Floer homology is finitely generated. Observe now that if  $[\emptyset] \neq 0$ , then  $\text{ECH}_*(B \times S^1, \xi_\Gamma, 0)$  cannot be finitely generated, as the generators  $\gamma_1, \gamma_2, \dots$  will be linearly independent, so this is a contradiction.  $\square$

*Remark 1.26.* Since the proof of Theorem 1.25 relies on gauge theory in addition to holomorphic curves, we do not know whether  $(B \times S^1, \xi_\Gamma)$  has a finite order of algebraic torsion when  $\Gamma$  divides  $B$  into two connected components with differing positive genus, and there is no apparent reason to believe that it should. It would be interesting to resolve this question, as it is not known thus far whether the filling obstructions furnished by SFT and the ECH contact invariant in dimension three are independent.

1.6.3. *Parabolic torus bundles.* A specific subclass of the contact circle bundles covered by the results above can also be described as torus bundles with parabolic monodromy. All such bundles can be presented in the form

$$T_\pm(k) := (\mathbb{R} \times \mathbb{T}^2) / (\rho, z) \sim (\rho + 1, \pm A_k z)$$

for some  $k \in \mathbb{Z}$ , where  $A_k = \begin{pmatrix} 1 & 0 \\ k & 1 \end{pmatrix}$ . We will denote the coordinates on  $\mathbb{T}^2 = S^1 \times S^1$  by  $(\phi, \theta)$ .

Given an integer  $m \geq 0$ , we define a *rotational* contact structure  $\zeta_m$  whose lift to  $\mathbb{R} \times \mathbb{T}^2$  can be written as

$$\zeta_m = \ker [f(\rho) d\theta + g(\rho) d\phi]$$

for some path  $(f, g) : \mathbb{R} \rightarrow \mathbb{R}^2 \setminus \{0\}$  that rotates about the origin by an angle of greater than  $2\pi m$  but at most  $2\pi(m+1)$  as  $\rho$  varies along a closed unit interval in  $\mathbb{R}$ . Also, for  $m \in \mathbb{N}$  we define

$$\eta_m = \ker (|k+1| \cos(2\pi m\phi) d\rho + \sin(2\pi m\phi) d\theta - k\rho \sin(2\pi m\phi) d\phi).$$

By results of Giroux [Gir99, Gir00], every universally tight contact structure on  $T_{\pm}(k)$  is diffeomorphic to at least one of these models.

Defining a circle bundle  $\pi : T_{+}(k) \rightarrow \mathbb{T}^2 = (\mathbb{R} \times S^1)/\mathbb{Z} : [(\rho, \phi, \theta)] \mapsto [(\rho, \phi)]$ , all of the contact structures  $\zeta_m$  and  $\eta_m$  are  $S^1$ -invariant and partitioned by multicurves  $\Gamma \subset \mathbb{T}^2$ , where:

- For  $\zeta_m$  with  $k \geq 0$ ,  $\Gamma$  consists of  $2(m+1)$  curves of the form  $\{\rho = \text{const}\}$ ;
- For  $\zeta_m$  with  $k < 0$ ,  $\Gamma$  consists of  $2m$  curves of the form  $\{\rho = \text{const}\}$ ;
- For  $\eta_m$ ,  $\Gamma$  consists of  $2m$  curves of the form  $\{\phi = \text{const}\}$ .

The Euler number of the bundle  $\pi : T_{+}(k) \rightarrow \mathbb{T}^2$  is  $k$ .

Note that for each  $m \in \mathbb{N}$ , [Gir99, Théorème 6] proves that  $(T_{+}(k), \eta_m)$  and  $(T_{+}(k), \zeta_{m-1})$  are contactomorphic when  $k \geq 0$ , while  $(T_{+}(k), \eta_m)$  and  $(T_{+}(k), \zeta_m)$  are contactomorphic when  $k < 0$ . Thus the following corollary of Theorem 1.21 covers all universally tight contact structures on  $T_{+}(k)$  with the exception of  $\zeta_0$  for  $k < 0$ :

**Corollary 1.27.** *Given  $k \in \mathbb{Z}$  and  $m \in \mathbb{N}$ ,  $(T_{+}(k), \eta_m)$  is strongly fillable if and only if  $m = 1$  and  $k \geq 0$ , and its strong fillings are all Lefschetz fibrations over the annulus with annular fibers and monodromy maps that fix the boundary.*  $\square$

Similarly, both families of contact structures on  $T_{-}(k)$  are  $S^1$ -invariant for the non-orientable circle bundle  $\pi : T_{-}(k) \rightarrow \mathbb{K}^2 : [(\rho, \phi, \theta)] \mapsto [(\rho, \phi)]$  over the Klein bottle

$$\mathbb{K}^2 = (\mathbb{R} \times S^1) / (\rho, \phi) \sim (\rho + 1, -\phi).$$

The multicurves  $\Gamma \subset \mathbb{K}^2$  can now be described as follows:

- For  $\zeta_m$ ,  $\Gamma$  consists of  $2m+1$  curves of the form  $\{\rho = \text{const}\}$  with trivial normal bundle;
- For  $\eta_m$ ,  $\Gamma$  includes the two curves  $\{\phi = 0\}$  and  $\{\phi = 1/2\}$  with nontrivial normal bundles and  $m-1$  additional curves of the form  $\{\rho = \text{const}\}$  with trivial normal bundles.

According to [Gir99, Théorème 6], all contact structures in this list on each individual manifold  $T_{-}(k)$  are pairwise non-diffeomorphic. For  $m \geq 1$ ,  $(T_{-}(k), \zeta_m)$  has positive Giroux torsion and is thus known to be not fillable. For  $(T_{-}(k), \zeta_0)$ ,  $\mathbb{K}^2 \setminus \Gamma$  is homotopy equivalent to an annulus and the condition  $k \leq 2(g+1)$  in Theorem 1.23 is satisfied but with strict inequality, so the Lefschetz-amenability condition fails and we cannot classify fillings (but see §1.7 for more on this example). It is also not hard to check that  $(T_{-}(k), \eta_m)$  has positive Giroux torsion for every  $m \geq 3$ . We do not know if it has Giroux torsion for  $m = 2$ . Nevertheless, Corollary 1.24 implies that  $(T_{-}(k), \eta_2)$  does have planar 1-torsion, and is thus non-fillable. Finally, for  $\eta_1$  we can apply Theorem 1.23 to deduce uniqueness of fillings. Notice that the Euler number of  $\pi : T_{-}(k) \rightarrow \mathbb{K}^2$  is  $-k$ . This yields:

**Corollary 1.28.** *Given  $k \in \mathbb{Z}$  and  $m \in \mathbb{N}$ ,  $(T_{-}(k), \eta_m)$  is strongly fillable if and only if  $m = 1$  and  $k \leq 0$ , and its strong fillings are all Lefschetz fibrations over the annulus with annular fibers and monodromy maps that interchange boundary components.*  $\square$

**Example 1.29.** The unique Stein filling of  $(T_{-}(0), \eta_1)$  is presentable as the smooth annulus fibration over the annulus  $[-1, 1] \times S^1$  such that the monodromy around  $\{*\} \times S^1$  is

$[-1, 1] \times S^1 \rightarrow [-1, 1] \times S^1 : (s, t) \mapsto (-s, -t)$  (i.e. the “flip” map appearing in the proof of Theorem 1.23).

**1.7. The non-amenable case and exotic fibers.** The most important part of Theorem 1.5 does not hold for spinal open books that are not Lefschetz-amenable, but our arguments will still provide something that we expect could be used to achieve a classification of fillings in the general case. The following is a summary of some more technical results proved in §6; for this discussion we permit ourselves the luxury of a slightly imprecise statement since we do not intend to prove anything with it.

**Proposition 1.30.** *Suppose  $(W, \omega)$  is a weak symplectic filling of a contact 3-manifold  $(M, \xi)$  supported by a partially planar spinal open book  $\pi$  such that  $\omega$  is exact on the spine  $M_\Sigma$ . Then  $(W, \omega)$  admits a symplectic completion  $\widehat{W}$  with a compatible almost complex structure  $J$  and a smooth surjective map*

$$\Pi : \widehat{W} \rightarrow \mathcal{M},$$

where  $\mathcal{M}$  is an oriented surface with cylindrical ends that are in bijective correspondence to the connected components of  $M_P$ , and every fiber  $\Pi^{-1}(*)$  is a (possibly nodal)  $J$ -holomorphic curve with cylindrical ends asymptotic to closed Reeb orbits in  $(M, \xi)$ . More precisely,  $\mathcal{M}$  admits a partition

$$\mathcal{M} = \mathcal{M}_{\text{reg}} \cup \mathcal{M}_{\text{sing}} \cup \mathcal{M}_{\text{exot}},$$

where  $\mathcal{M}_{\text{sing}}$  and  $\mathcal{M}_{\text{exot}}$  are each finite sets, and

- Fibers in  $\Pi^{-1}(\mathcal{M}_{\text{reg}})$  are embedded  $J$ -holomorphic curves asymptotic to simply covered Reeb orbits;
- Fibers in  $\Pi^{-1}(\mathcal{M}_{\text{sing}})$  are nodal  $J$ -holomorphic curves asymptotic to simply covered Reeb orbits, each formed as the union of two embedded curves that intersect each other exactly once, transversely;
- Fibers in  $\Pi^{-1}(\mathcal{M}_{\text{exot}})$  are embedded  $J$ -holomorphic curves with one end asymptotic to a doubly covered Reeb orbit, and all other ends asymptotic to simply covered orbits.

For each vertebra  $\Sigma_i$ , there is also a properly embedded  $J$ -holomorphic curve  $S_i \subset \widehat{W}$  such that

$$\Pi|_{S_i} : S_i \rightarrow \mathcal{M}$$

is a proper branched cover with simple branch points and is  $m_\gamma$ -to-1 on the cylindrical end corresponding to each boundary component of  $\gamma \subset \partial\Sigma_i$ , where  $m_\gamma \in \mathbb{N}$  is the corresponding multiplicity (see Definition 1.2). Moreover,  $\Pi|_{S_i}$  is an honest covering map (i.e. without branch points) if and only if  $\mathcal{M}_{\text{exot}} = \emptyset$ . Finally, all of this data deforms smoothly under generic deformations of  $J$  compatible with deformations of the symplectic structure.

The distinguishing feature of the Lefschetz-amenable case is that the set  $\mathcal{M}_{\text{exot}}$  is guaranteed to be empty, in which case we will show in §6.5 that  $\Pi : \widehat{W} \rightarrow \mathcal{M}$  gives rise to a Lefschetz fibration filling  $\pi$ , with singular fibers corresponding to the finite set  $\mathcal{M}_{\text{sing}}$ . When this condition fails and  $\Pi|_{S_i} : S_i \rightarrow \mathcal{M}$  has branch points, the proposition yields a more general type of decomposition of the filling, including the so-called **exotic fibers**  $\Pi^{-1}(u)$  for  $u \in \mathcal{M}_{\text{exot}}$ . These are singular in the sense that they have different topology from the nearby regular fibers, but their singularities occur “at infinity” and resemble the multiple fibers of a Seifert fibration on a 3-manifold. We will not attempt a more precise topological description



of exotic fibers here, but we are fairly confident that such a description could be used in general to prove classification results for fillings without the Lefschetz-amenability assumption. We now give three examples where one can see that exotic fibers must appear.

**Example 1.31.** The parabolic torus bundles  $(T_-(k), \zeta_0)$  discussed in §1.6.3 can be presented as  $S^1$ -invariant contact structures on circle bundles over the Klein bottle  $\mathbb{K}^2$ , partitioned along a single co-orientable curve  $\Gamma \subset \mathbb{K}^2$  such that  $\mathbb{K}^2 \setminus \Gamma$  is a cylinder. It follows that  $(T_-(k), \zeta_0)$  is supported by a spinal open book  $\pi$  with one spine component fibering over the annulus, and one family of annular pages whose two boundary components meet the spine at separate boundary components, each with multiplicity 1. The uniformity condition is satisfied because there exists a double branched cover of  $[-1, 1] \times S^1$  over the disk whose restriction to each boundary component has degree 1, but since every such branched cover has (algebraically) two branch points,  $\pi$  is not Lefschetz-amenable. Proposition 1.30 now endows the completion  $\widehat{W}$  of any filling of  $(T_-(k), \zeta_0)$  with a  $J$ -holomorphic foliation that includes exotic fibers.

*Remark 1.32.* Note that while fillings of  $(T_-(k), \zeta_0)$  cannot be presented as Lefschetz fibrations filling  $\pi$ , they do sometimes exist: e.g.  $(T_-(0), \zeta_0)$  can be presented as a quotient of the standard contact  $\mathbb{T}^3$  by a free contact  $\mathbb{Z}_2$ -action that extends over the filling  $T^*\mathbb{T}^2$  of  $\mathbb{T}^3$  as a symplectic  $\mathbb{Z}_2$ -action with four fixed points on the zero-section. The resulting symplectic orbifold has four singular points with neighborhoods bounded by the standard contact  $\mathbb{R}P^3$ , so the singularities can be resolved by replacing these neighborhoods with neighborhoods of the zero-section in  $T^*S^2$ . If we choose a  $\mathbb{Z}_2$ -invariant plurisubharmonic function on  $T^*\mathbb{T}^2$  with local minima at the four fixed points, then this desingularization results in a Stein filling  $W$  of  $(T_-(0), \zeta_0)$ . Note that  $H_2(W) \neq 0$ , whereas the unique Stein filling of  $(T_-(0), \eta_1)$  that we saw in Example 1.29 has trivial second homology, so this furnishes a new proof of Giroux's theorem [Gir99] that  $\zeta_0$  and  $\eta_1$  are non-isomorphic contact structures on  $T_-(0)$ .

**Example 1.33.** The standard contact structure  $\xi_{\text{std}}$  on  $S^1 \times S^2$  can be written in the form  $\ker [f(\theta) dt + g(\theta) d\phi]$  where  $t \in S^1 = \mathbb{R}/\mathbb{Z}$  is the standard coordinate,  $(\theta, \phi)$  are spherical polar coordinates on  $S^2$ , and  $(f, g) : [0, \pi] \rightarrow \mathbb{R}^2$  traces a path that winds counterclockwise from the positive to the negative  $x$ -axis. Choosing  $f$  and  $g$  to be odd and even functions respectively, we can define the quotient

$$(M, \xi) = (S^1 \times S^2, \xi_{\text{std}}) / (t, \theta, \phi) \sim (-t, \pi - \theta, \phi + \pi),$$

which is a non-orientable circle bundle over  $\mathbb{R}P^2$  with orientable total space. The open book  $(S^1 \times S^2) \setminus \{\theta = 0, \pi\} \rightarrow S^1 : (t, \theta, \phi) \mapsto \phi$  then projects to a *rational* open book on  $M$  supporting  $\xi$ , with one binding component and annular pages such that the monodromy is an involution exchanging boundary components. This can also be interpreted as a spinal open book  $\pi$ , where the spine is a single solid torus and the paper is a single  $S^1$ -family of annuli touching it with multiplicity 2; in fact, this is the same construction that arises naturally if we view  $(M, \xi)$  as a circle bundle. Since the only vertebra is a disk, uniformity demands a branched double cover of  $\mathbb{D}^2$  over itself, and such a cover will always have one branch point, so  $\pi$  is not Lefschetz-amenable. Any completed filling of  $(M, \xi)$  will then carry a foliation whose generic leaves are  $J$ -holomorphic cylinders, but that also includes exotic fibers in the form of  $J$ -holomorphic planes asymptotic to a doubly covered Reeb orbit.

**Example 1.34.** We now exhibit a planar spinal open book that is not Lefschetz-amenable for which some but not all fillings can be described as Lefschetz fibrations.

Let  $\Sigma_g$  denote the compact connected and oriented surface with genus  $g$ , and denote by  $\Sigma_{g,m}$  the compact surface with boundary obtained by punching  $m$  holes in  $\Sigma_g$ . The surface  $\Sigma_{2,2}$  admits two double branched covers

$$\Sigma_{2,2} \xrightarrow{\varphi_1} \Sigma_{1,2}, \quad \Sigma_{2,2} \xrightarrow{\varphi_0} \Sigma_{0,2},$$

where both are 2-to-1 maps on each boundary component, and the Riemann-Hurwitz formula implies that  $\varphi_1$  is unbranched, while  $\varphi_0$  has four simple branch points. The resulting deck transformations define a pair of orientation-preserving involutions

$$\psi_1, \psi_0 : \Sigma_{2,2} \rightarrow \Sigma_{2,2},$$

which we can assume are symplectic for suitable choices of area forms on  $\Sigma_{2,2}$ . Now consider a Weinstein domain defined via the trivial annulus fibration  $\tilde{E} = \Sigma_{2,2} \times \Sigma_{0,2}$ ; using the natural correspondence between annular spinal open books and circle bundles, we can view the contact boundary  $(\tilde{M}, \tilde{\xi})$  of  $\tilde{E}$  as a trivial circle bundle over the symmetric double  $\Sigma_5$  formed by gluing together two copies of  $\Sigma_{2,2}$  along an orientation-reversing map of their boundaries, and  $\tilde{\xi}$  is an  $S^1$ -invariant contact structure partitioned by  $\partial\Sigma_{2,2} \subset \Sigma_5$ . The contact manifold we're actually interested in is a  $\mathbb{Z}_2$ -quotient of this: define the Weinstein domain

$$E = (\Sigma_{2,2} \times \Sigma_{0,2}) / (z, w) \sim (\psi_1(z), \sigma(w)),$$

where  $\sigma$  is the involution  $(s, t) \mapsto (-s, -t)$  on  $\Sigma_{0,2} = [-1, 1] \times S^1$ . This is obviously a symplectic manifold (for suitable choices of area forms on  $\Sigma_{2,2}$  and  $\Sigma_{0,2}$ ) since the involution  $\psi_1 \times \sigma$  is symplectic and without fixed points, and one can see its Weinstein structure in terms of the natural annulus fibration over  $\Sigma_{2,2}/\mathbb{Z}_2 = \Sigma_{1,2}$  that it inherits from the trivial annulus fibration on  $\tilde{E}$ . The induced spinal open book  $\pi$  on the boundary  $(M, \xi)$  of  $E$  has two paper components with monodromy exchanging the boundary components of the annulus, and these are attached to separate boundary components of a single spine component of the form  $S^1 \times \Sigma_{2,2}$ . Viewing  $(M, \xi)$  as an  $S^1$ -invariant circle bundle, it fibers over the union of  $\Sigma_{2,2}$  with two Möbius bands, i.e.  $\Sigma_2 \# 2\mathbb{R}P^2$ , with  $\xi$  partitioned by a multicurve  $\Gamma \subset \Sigma_2 \# 2\mathbb{R}P^2$  with two components, both not co-orientable, and  $(\Sigma_2 \# 2\mathbb{R}P^2) \setminus \Gamma$  is thus a genus 2 surface with two cylindrical ends. As a consequence, the condition  $k \leq 2(g+1)$  in Theorem 1.23 is satisfied, but with strict inequality, so  $\pi$  is not Lefschetz-amenable.

In the context of Proposition 1.30, this means that there are multiple possibilities for an unknown filling  $W$  of  $(M, \xi)$ : it may indeed admit a Lefschetz fibration over  $\Sigma_{1,2}$  since there exist unbranched double covers  $\Sigma_{2,2} \rightarrow \Sigma_{1,2}$ , and the filling  $E$  described above is an example of this. But the moduli space  $\mathcal{M}$  in the proposition could also have the topology of  $\Sigma_{0,2}$ , with the branch points of  $\varphi_0 : \Sigma_{2,2} \rightarrow \Sigma_{0,2}$  giving rise to exotic fibers. To see that this also *must* sometimes happen, notice that we can define an alternative filling of  $(M, \xi)$  by starting from the symplectic orbifold

$$\hat{E}' := (\Sigma_{2,2} \times \Sigma_{0,2}) / (z, w) \sim (\psi_0(z), \sigma(w)),$$

as the spinal open book on  $\partial\tilde{E}$  induced by the trivial fibration also descends to  $\pi$  on  $\partial\hat{E}' = \partial\tilde{E}/\mathbb{Z}_2$ . The singularities of  $\hat{E}'$  at fixed points of  $\psi_0 \times \sigma$  (two for each branch point of  $\varphi_0$ ) can be resolved by replacing neighborhoods with copies of  $T^*S^2$  (cf. Remark 1.32). Choosing a  $\mathbb{Z}_2$ -invariant plurisubharmonic function on  $\Sigma_{2,2} \times \Sigma_{0,2}$  with local minima at the fixed points, one produces in this way a new Stein filling  $E'$  of  $(M, \xi)$ , in which the eight orbifold singularities of  $\hat{E}'$  have been replaced by Lagrangian spheres.

We now notice that the contact manifolds  $\partial E$  and  $\partial E'$  are both circle bundles over the same non-orientable base, with invariant contact structures, partitioned by the same multicurve. Furthermore, by constructing a section of  $\partial \tilde{E} \rightarrow \Sigma_5$  that is  $\mathbb{Z}_2$ -equivariant for either of the two  $\mathbb{Z}_2$ -actions, we deduce that these two are the same bundle. By construction,  $E'$  has eight Lagrangian spheres, and we claim that  $E$  has none, thus proving that  $E$  and  $E'$  are non-diffeomorphic Stein fillings of  $(M, \xi)$ . Indeed, the map  $\tilde{E} \rightarrow E$  is an honest 2-to-1 covering map, so the preimage of any Lagrangian sphere in  $E$  would be a pair of Lagrangian spheres in  $\tilde{E}$ , in particular, having square  $-2$ . But all classes in  $H_2(\tilde{E})$  have self-intersection 0 by the Künneth formula (or alternatively: none of them are represented by spheres, since  $\pi_2(\tilde{E})$  is trivial).

## 2. GENERALITIES ON PUNCTURED HOLOMORPHIC CURVES

The contents of this section are mostly standard, but a quick review seems worthwhile in order to fix terminology and notation in preparation for later holomorphic curve arguments.

**2.1. Stable Hamiltonian structures and symplectization ends.** Stable Hamiltonian structures (or “SHS” for short) were first introduced in a dynamical context in [HZ94] and reappeared in [BEH<sup>+</sup>03] as the natural setting for the theory of punctured holomorphic curves. For our purposes, they provide a convenient generalization of the notion of the *symplectization* of a contact manifold. The particular SHS that arise in this paper can be thought of as degenerate limits of certain contact forms in which explicit constructions of holomorphic curves become much easier. For a more comprehensive discussion of the topology of stable Hamiltonian structures, see [CV].

Given an oriented  $(2n - 1)$ -dimensional manifold  $M$ , a pair

$$\mathcal{H} = (\Omega, \Lambda)$$

consisting of a smooth 2-form  $\Omega$  and 1-form  $\Lambda$  is called a **stable Hamiltonian structure** if

- (i)  $\Lambda \wedge \Omega^{n-1} > 0$ ,
- (ii)  $d\Omega = 0$ ,
- (iii)  $\ker \Omega \subset \ker d\Lambda$ .

Such a pair gives rise to two important objects: a co-oriented hyperplane distribution  $\Xi := \ker \Lambda$ , and a positively transverse vector field  $R_{\mathcal{H}}$  determined by the conditions

$$\Omega(R_{\mathcal{H}}, \cdot) \equiv 0 \quad \text{and} \quad \Lambda(R_{\mathcal{H}}) \equiv 1.$$

By analogy with contact forms, we will refer to  $R_{\mathcal{H}}$  as the **Reeb vector field** of  $\mathcal{H}$ . It reduces to the usual contact notion of the Reeb vector field for  $\Lambda$  whenever the latter happens also to be a contact form; SHS with this property will be said to be of **contact type**. Note that this definition does not require  $\Omega$  to exact, though  $(d\Lambda, \Lambda)$  is always an example of an SHS when  $\Lambda$  is contact. If  $\dim M = 3$ , we will say that  $\mathcal{H} = (\Omega, \Lambda)$  is of **confoliation type** whenever

$$\Lambda \wedge d\Lambda \geq 0,$$

which is equivalent to the condition  $d\Lambda|_{\Xi} \geq 0$  and means that  $\Xi \subset TM$  is a *confoliation* in the sense of [ET98].

Stable Hamiltonian structures arise naturally in the context of **stable hypersurfaces** as defined in [HZ94]. Given a symplectic manifold  $(W, \omega)$ , a compact hypersurface  $M \subset W$  is called **stable** if there exists a vector field  $Z$  on a neighborhood of  $M$  in  $W$  that is everywhere

transverse to  $M$  and determines a 1-parameter family of hypersurfaces with isomorphic characteristic line fields: more precisely, this means that if  $\Phi_Z^t$  denotes the flow of  $Z$ , then the real line bundle

$$\ker((\Phi_Z^t)^*\omega|_{TM}) \subset TM$$

is independent of  $t$  near  $t = 0$ . In this case we call  $Z$  a **stabilizing vector field** for  $M$ , and the pair  $(\Omega, \Lambda)$  defined by

$$\Omega := \omega|_{TM}, \quad \Lambda := \iota_Z \omega|_{TM}$$

is an SHS on  $M$ . One can use the Moser deformation trick to show that a neighborhood of  $M$  in  $(W, \omega)$  is then symplectomorphic to a collar of the form

$$(2.1) \quad ((-\delta, \delta) \times M, d(t\Lambda) + \Omega)$$

for sufficiently small  $\delta > 0$ , where  $t$  denotes the coordinate on  $(-\delta, \delta)$  and the symplectomorphism identifies  $\{0\} \times M$  with  $M \subset W$ . Conversely,  $d(t\Lambda) + \Omega$  is symplectic on  $(-\delta, \delta) \times M$  whenever  $(\Omega, \Lambda)$  is an SHS and  $\delta > 0$  is sufficiently small. The following variant of (2.1) is less commonly seen in the literature but will be convenient for our purposes: defining the alternative coordinate  $r := \log(t + 1)$  on the first factor and adjusting the value of  $\delta > 0$  accordingly, (2.1) becomes

$$(2.2) \quad ((-\delta, \delta) \times M, d((e^r - 1)\Lambda) + \Omega).$$

As an important special case,  $Z$  is always stabilizing if it is a **Liouville** vector field transverse to  $M$ , i.e.  $\mathcal{L}_Z \omega = \omega$ . In this case  $\lambda := \iota_Z \omega$  satisfies  $d\lambda = \omega$  and restricts to  $M$  as a contact form  $\alpha := \lambda|_{TM}$ , hence the resulting stable Hamiltonian structure is  $(d\alpha, \alpha)$  and the symplectic structure in (2.2) takes the form  $d(e^r \alpha)$ , one of the standard formulas for the symplectization  $\mathbb{R} \times M$  of the contact manifold  $(M, \Xi = \ker \alpha)$ .

By analogy with the contact case, one can define the **symplectization of  $(M, \mathcal{H})$**  for any stable Hamiltonian structure  $\mathcal{H} = (\Omega, \Lambda)$  by choosing suitable diffeomorphisms of (2.2) with  $\mathbb{R} \times M$ : equivalently, this means we consider  $\mathbb{R} \times M$  with the family of symplectic forms  $\omega_\varphi$  defined by

$$(2.3) \quad \omega_\varphi := d\left((e^{\varphi(r)} - 1)\Lambda\right) + \Omega,$$

where  $\varphi$  is chosen arbitrarily from the set

$$(2.4) \quad \mathcal{T} := \{\varphi \in C^\infty(\mathbb{R}, (-\delta, \delta)) \mid \varphi' > 0\}.$$

More generally, suppose  $(W, \omega)$  is a compact  $2n$ -dimensional symplectic manifold with stable boundary  $\partial W = -M_- \amalg M_+$ , equipped with a stabilizing vector field  $Z$  that points inward at  $M_-$  and outward at  $M_+$ . Denote the induced SHS on  $M_\pm$  by  $\mathcal{H}_\pm = (\Omega_\pm, \Lambda_\pm)$ ; note that the orientation conventions here are chosen such that  $\Lambda_\pm \wedge \Omega_\pm^{n-1} > 0$  on  $M_\pm$ . We can now identify neighborhoods of  $M_\pm$  in  $(W, \omega)$  symplectically with collars of the form

$$\begin{aligned} &([0, \delta) \times M_+, d((e^r - 1)\Lambda_+) + \Omega_+), \\ &((-\delta, 0] \times M_-, d((e^r - 1)\Lambda_-) + \Omega_-). \end{aligned}$$

Modifying (2.4) to

$$(2.5) \quad \mathcal{T} := \{\varphi \in C^\infty(\mathbb{R}, (-\delta, \delta)) \mid \varphi' > 0 \text{ and } \varphi(r) = r \text{ for } r \text{ near } 0\},$$

we can use any  $\varphi \in \mathcal{T}$  to define a **symplectic completion**  $(\widehat{W}, \omega_\varphi)$  of  $(W, \omega)$  by

$$\widehat{W} := ((-\infty, 0] \times M_-) \cup_{M_-} W \cup_{M_+} ([0, \infty) \times M_+),$$

where the above collar neighborhoods are used to glue the pieces together smoothly and the symplectic form is defined by

$$\omega_\varphi := \begin{cases} d((e^{\varphi(r)} - 1)\Lambda_-) + \Omega_- & \text{on } (-\infty, 0] \times M_-, \\ \omega & \text{on } W, \\ d((e^{\varphi(r)} - 1)\Lambda_+) + \Omega_+ & \text{on } [0, \infty) \times M_+. \end{cases}$$

**2.2. Finite energy holomorphic curves.** Given a stable Hamiltonian structure  $\mathcal{H} = (\Omega, \Lambda)$  with induced hyperplane field  $\Xi = \ker \Lambda$  and Reeb vector field  $R_{\mathcal{H}}$ , we denote by  $\mathcal{J}(\mathcal{H})$  the space of  $\mathbb{R}$ -invariant almost complex structures on the symplectization  $\mathbb{R} \times M$  that are **compatible** with  $\mathcal{H}$ , meaning that for  $J \in \mathcal{J}(\mathcal{H})$ ,

- (i)  $J\partial_r = R_{\mathcal{H}}$ , where  $\partial_r$  denotes the unit vector in the  $\mathbb{R}$ -direction;
- (ii)  $J(\Xi) = \Xi$  and  $\Omega(\cdot, J\cdot)$  defines a bundle metric on  $\Xi$ .

In the special case  $(\Omega, \Lambda) = (d\alpha, \alpha)$  with  $\alpha$  a contact form, this reproduces the standard definition for almost complex structures compatible with contact forms, and we shall in this case abbreviate

$$\mathcal{J}(\alpha) := \mathcal{J}(\mathcal{H}), \quad \text{where } \mathcal{H} := (d\alpha, \alpha).$$

The following trivial observation will be helpful because it permits the use of a slightly non-standard stable Hamiltonian structure (in particular with  $\Omega$  non-exact) for computing holomorphic curve invariants that are usually defined in terms of contact forms.

**Proposition 2.1.** *Suppose  $\dim M = 3$ ,  $\alpha$  is a contact form, and  $\Omega$  is any closed 2-form for which  $\mathcal{H} := (\Omega, \alpha)$  is a stable Hamiltonian structure. Then  $\mathcal{J}(\mathcal{H}) = \mathcal{J}(\alpha)$ .*

*Proof.* Since  $\alpha$  is contact, the Reeb vector field  $R_{\mathcal{H}}$  is the same as the contact Reeb vector field for  $\alpha$ . The only difference between the conditions defining  $\mathcal{J}(\mathcal{H})$  and  $\mathcal{J}(\alpha)$  is thus that  $J: \Xi \rightarrow \Xi$  must be compatible with  $\Omega|_{\Xi}$  in the first case and compatible with  $d\alpha|_{\Xi}$  in the second case. Since  $\Xi$  is complex 1-dimensional and  $\Omega|_{\Xi}$  and  $d\alpha|_{\Xi}$  induce the same orientation, these conditions are identical.  $\square$

Any given  $J \in \mathcal{J}(\mathcal{H})$  is tamed by all of the symplectic forms  $\omega_\varphi$  in (2.3) on the symplectization  $\mathbb{R} \times M$  if the constant  $\delta > 0$  in (2.4) is chosen sufficiently small; in the case  $\dim M = 3$ , which will be our primary interest,  $J$  is also  $\omega_\varphi$ -compatible for all  $\varphi \in \mathcal{T}$ . Given a Riemann surface  $(S, j)$  and  $J$ -holomorphic curve  $u: (S, j) \rightarrow (\mathbb{R} \times M, J)$ , we therefore define the **energy** of  $u$  by

$$(2.6) \quad E(u) := \sup_{\varphi \in \mathcal{T}} \int_S u^* \omega_\varphi.$$

The same formula can be used to define the energy of a  $J$ -holomorphic curve  $u: (S, j) \rightarrow (\widehat{W}, J)$ , where  $\widehat{W}$  denotes the completion of a cobordism  $(W, \omega)$  with stable boundary  $-M_- \amalg M_+$  as in §2.1, and  $J$  is chosen from the space

$$\mathcal{J}(\omega, \mathcal{H}_+, \mathcal{H}_-)$$

consisting of almost complex structures  $J$  on  $\widehat{W}$  such that  $J|_W$  is compatible with  $\omega$  and

$$\begin{aligned} J_+ &:= J|_{[0, \infty) \times M_+} \in \mathcal{J}(\mathcal{H}_+), \\ J_- &:= J|_{(-\infty, 0] \times M_-} \in \mathcal{J}(\mathcal{H}_-). \end{aligned}$$

Any  $J \in \mathcal{J}(\omega, \mathcal{H}_+, \mathcal{H}_-)$  is  $\omega_\varphi$ -tame on  $\widehat{W}$  for every  $\varphi \in \mathcal{T}$ , hence the energy (2.6) is always nonnegative, and is positive unless the curve is constant.

*Remark 2.2.* The notion of energy described here is slightly different from the one defined in [BEH<sup>+</sup>03], but is equivalent to it in the sense that uniform bounds on either imply uniform bounds on the other.

We will always take the domain of our holomorphic curves to be punctured Riemann surfaces  $\dot{S} = S \setminus \Gamma$ , i.e.  $(S, j)$  is a closed Riemann surface and  $\Gamma \subset S$  is a finite ordered set. The surface  $\dot{S}$  will also be assumed to be connected unless otherwise specified. When this needs to be emphasized, we will call a curve  $u : \dot{S} \rightarrow \widehat{W}$  **connected** whenever its domain is connected; if  $\dot{S}$  is disconnected, then the **connected components** of  $u$  are defined to be its restriction to the connected components of  $\dot{S}$ . A punctured  $J$ -holomorphic curve  $u : \dot{S} \rightarrow \widehat{W}$  with positive finite energy is either positively or negatively asymptotic to periodic orbits of  $R_{\mathcal{H}_+}$  or  $R_{\mathcal{H}_-}$  respectively at each of its nonremovable punctures; in short, finite energy punctured  $J$ -holomorphic curves are **asymptotically cylindrical**, cf. [BEH<sup>+</sup>03].

*Remark 2.3.* The terms “finite energy” and “asymptotically cylindrical” are often used as synonyms when describing  $J$ -holomorphic curves, and we shall generally consider these conditions to be implied whenever we refer to “punctured” holomorphic curves. The underlying presumption, unless stated otherwise, is always that the domain is the complement of a finite (sometimes empty) set of points in a closed Riemann surface, and that all the punctures are non-removable.

We consider two holomorphic curves equivalent if they are related to each other by biholomorphic maps of their domains that take punctures to punctures with the ordering of punctures preserved. The resulting equivalence classes are called **unparametrized**  $J$ -holomorphic curves. We will often abuse notation and use a parametrized map  $u : \dot{S} \rightarrow \widehat{W}$  to refer to the *unparametrized* curve that it represents. When speaking of moduli spaces, we will always mean a space of unparametrized  $J$ -holomorphic curves that are asymptotically cylindrical, with a topology such that a sequence is considered to converge if and only if one can find parametrizations with a fixed punctured domain  $\dot{S} = S \setminus \Gamma$  such that the complex structures on  $S$  converge in  $C^\infty$  while the maps  $\dot{S} \rightarrow \widehat{W}$  converge in  $C^\infty$  on compact subsets and in  $C^0$  up to the cylindrical ends (measured via any choice of translation-invariant metric on the ends). For a given  $J$ , the corresponding moduli will typically be denoted by

$$\mathcal{M}(J).$$

In the  $\mathbb{R}$ -invariant case  $J \in \mathcal{J}(\mathcal{H})$ , an important example of a finite energy holomorphic curve is the **trivial cylinder**

$$u : \mathbb{R} \times S^1 \rightarrow \mathbb{R} \times M : (s, t) \mapsto (Ts, x(Tt))$$

over any orbit  $x : \mathbb{R} \rightarrow M$  with  $x(T) = x(0)$  for  $T > 0$ ; this curve can be parametrized as a punctured sphere with one positive and one negative puncture, both approaching the same orbit. We shall sometimes abbreviate the unparametrized curve represented by the trivial cylinder described above as

$$\mathbb{R} \times \gamma,$$

where  $\gamma : S^1 \rightarrow M : t \mapsto x(Tt)$  specifies the periodic orbit in question, which may in general be multiply covered.

If the asymptotic orbits of a finite energy  $J$ -holomorphic curve  $u$  are all nondegenerate or Morse-Bott, then the moduli space  $\mathcal{M}(J)$  near  $u$  can be described as the zero set of a Fredholm section whose index corresponds to the **virtual dimension** of the moduli space

near  $u$ . We will call this virtual dimension the **index** of  $u$  and denote it by  $\text{ind}(u) \in \mathbb{Z}$ . By a punctured version of the Riemann-Roch theorem (see [Sch95]), the index of a curve  $u : \dot{S} \rightarrow \widehat{W}$  can be written as

$$(2.7) \quad \text{ind}(u) = (n-3)\chi(\dot{S}) + 2c_1^\Phi(u^*T\widehat{W}) + \sum_{z \in \Gamma^+} \mu_{\text{CZ}}^\Phi(\gamma_z) - \sum_{z \in \Gamma^-} \mu_{\text{CZ}}^\Phi(\gamma_z),$$

where  $\dim_{\mathbb{R}} \widehat{W} = 2n$ ,  $\Gamma = \Gamma^+ \amalg \Gamma^-$  are the positive and negative punctures with asymptotic orbits  $\{\gamma_z\}_{z \in \Gamma}$ ,  $\Phi$  is an arbitrary choice of complex trivializations for the bundles  $\Xi_{\pm} = \ker \Lambda_{\pm}$  along these orbits,  $\mu_{\text{CZ}}^\Phi(\gamma_z) \in \mathbb{Z}$  are the Conley-Zehnder indices relative to these trivializations, and  $c_1^\Phi(u^*T\widehat{W})$  is the relative first Chern number of  $u^*T\widehat{W} \rightarrow \dot{S}$  with respect to the asymptotic trivialization determined up to homotopy by  $\Phi$ . The curve  $u$  is said to be **Fredholm regular** if it represents a transverse intersection of the aforementioned Fredholm section with the zero section: in this case a neighborhood of  $u$  in  $\mathcal{M}(J)$  is a smooth orbifold (or manifold if  $u$  has no automorphisms) of dimension  $\text{ind}(u)$ . For further discussion of Fredholm regularity, see for example [Wen10b].

Every asymptotically cylindrical holomorphic curve is either **simple** (and thus **somewhere injective**) or **multiply covered**, where the latter means that it factors as the composition of another  $J$ -holomorphic curve with a branched cover of closed Riemann surfaces with degree at least two. By various standard transversality results (see for example [MS04, Dra04, Wenb]), the relevant spaces of compatible almost complex structures admit comeager subsets for which all simple curves are Fredholm regular. We will generally say that  $J$  is **generic** whenever it belongs to the comeager subset for which the relevant transversality result of this type holds.

It is sometimes useful to observe that if  $\dim M = 3$  and  $J \in \mathcal{J}(\mathcal{H})$  where  $\mathcal{H} = (\Omega, \Lambda)$  is a confoliation-type SHS, then every  $J$ -holomorphic curve  $u : \dot{S} \rightarrow \mathbb{R} \times M$  satisfies  $u^*d\Lambda \geq 0$ . Since the period of any closed orbit of  $R_{\mathcal{H}}$  parametrized by a loop  $\gamma : S^1 \rightarrow M$  is given by  $\int_{S^1} \gamma^* \Lambda$ , the following is an immediate consequence of Stokes' theorem:

**Proposition 2.4.** *Suppose  $\dim M = 3$ ,  $\mathcal{H} = (\Omega, \Lambda)$  is a confoliation-type stable Hamiltonian structure,  $J \in \mathcal{J}(\mathcal{H})$  and  $u : \dot{S} \rightarrow \mathbb{R} \times M$  is a nonconstant finite energy  $J$ -holomorphic curve with positive and/or negative punctures  $\Gamma = \Gamma^+ \cup \Gamma^-$  asymptotic to the periodic orbits  $\{\gamma_z\}_{z \in \Gamma}$ . Then  $\#\Gamma^+ \geq 1$ , and the periods  $T(\gamma_z) > 0$  of the orbits  $\gamma_z$  satisfy*

$$\sum_{z \in \Gamma^+} T(\gamma_z) - \sum_{z \in \Gamma^-} T(\gamma_z) \geq 0.$$

□

Given  $J \in \mathcal{J}(\omega, \mathcal{H}_+, \mathcal{H}_-)$  with the closed orbits of  $R_{\mathcal{H}_+}$  and  $R_{\mathcal{H}_-}$  assumed nondegenerate or Morse-Bott, moduli spaces of punctured  $J$ -holomorphic curves in  $(\widehat{W}, J)$  with uniform energy bounds satisfy a compactness theorem described in [BEH<sup>+</sup>03]. The compactified moduli space

$$\overline{\mathcal{M}}(J)$$

consist of so-called (stable) **holomorphic buildings**, which generalize the “broken” holomorphic curves familiar from Floer homology. For our purposes,<sup>4</sup> the objects in this compactification can be described as follows. A **nodal  $J$ -holomorphic curve** in  $\widehat{W}$ , also sometimes

<sup>4</sup>In our description of holomorphic buildings we ignore certain technical details such as *decorations*, which play no role in our arguments; these details are explained fully in [BEH<sup>+</sup>03].

called a *holomorphic building of height 1*, is an equivalence class of tuples

$$(S, j, \Gamma, u, \Delta)$$

where  $(S, j)$  is a closed but not necessarily connected Riemann surface,  $\Gamma \subset S$  is a finite ordered set defining the punctured surface  $\dot{S} := S \setminus \Gamma$ ,  $u : (\dot{S}, j) \rightarrow (\widehat{W}, J)$  is an asymptotically cylindrical  $J$ -holomorphic curve and  $\Delta$  is a finite unordered set of unordered pairs  $\{z_+, z_-\}$  of distinct points in  $\dot{S}$  such that  $u(z_+) = u(z_-)$ . Each pair  $\{z_+, z_-\} \in \Delta$  is called a **node**, and we sometimes also refer to the individual points  $z_{\pm} \in \dot{S}$  as **nodal points**. Two nodal curves are equivalent if they are related by a biholomorphic identification of their domains that preserves all the structure (including ordering of the punctures and pairing of the nodal points). Note that the asymptotically cylindrical behavior of  $u$  automatically partitions  $\Gamma$  into sets of positive and negative punctures  $\Gamma = \Gamma^+ \amalg \Gamma^-$ . Nodal curves in the symplectizations  $\mathbb{R} \times M_{\pm}$  can be defined in the same way, with the additional feature that  $\mathbb{R}$ -translations act on the space of nodal curves, so that one can also strengthen the equivalence relation and consider  $\mathbb{R}$ -equivalence classes of nodal curves.

A **holomorphic building** in  $(\widehat{W}, J)$  can now be regarded as a finite ordered list of nodal curves  $u = (u_1, \dots, u_N)$  for some  $N \in \mathbb{N}$ , which are called **levels** of  $u$ , and have the following properties and additional data:

- Exactly one of the levels  $u_M$  for some  $M \in \{1, \dots, N\}$  is a nodal curve in  $\widehat{W}$ ; this is called the **main level** of the building. It is also allowed to be *empty*, meaning its domain is the empty set.
- Every level  $u_{\ell}$  for  $\ell \neq M$  is a nonempty  $\mathbb{R}$ -equivalence class of nodal curves in one of the symplectizations  $\mathbb{R} \times M_{\pm}$ ;  $M_-$  for  $\ell < M$  and  $M_+$  for  $\ell > M$ . These are called **lower** and **upper levels** respectively.
- For each  $\ell \in \{1, \dots, N-1\}$ ,  $u$  is endowed with the additional data of a bijection from the positive punctures of  $u_{\ell}$  to the negative punctures of  $u_{\ell+1}$  such that the asymptotic orbits of punctures that correspond under this bijection are identical. We will refer to corresponding pairs of punctures as **breaking punctures** and their asymptotic orbits as **breaking orbits**.

The positive and negative punctures of the building  $u = (u_1, \dots, u_N)$  are defined as the positive punctures of  $u_N$  and the negative punctures of  $u_1$  respectively, and the **connected components** of  $u$  are the connected components of its constituent levels. One can define from  $u$  a topological surface  $\widehat{S}$  obtained from the disjoint union of the domains of all the levels by performing connected sums along all the paired-up nodal points forming nodes and all the corresponding breaking punctures. The building is then said to be **connected** if and only if  $\widehat{S}$  is connected, and its **arithmetic genus** is the genus of  $\widehat{S}$ . This punctured surface is diffeomorphic to the domain of any sequence of smooth curves that converge to the building in the SFT-topology; in particular, any such sequence admits a sequence of parametrizations  $u_k : \dot{S} \rightarrow \widehat{W}$  that can be transformed into a  $C^0$ -convergent sequence of continuous maps  $\dot{S} \rightarrow W$  by projecting cylindrical ends and upper/lower levels to  $M_{\pm}$  and gluing the components of the limiting building together along nodes and breaking orbits. The buildings that form  $\overline{\mathcal{M}}(J)$  are also always assumed to be **stable**, which means that none of the upper or lower levels is a disjoint union of trivial cylinders, and any connected component with genus zero on which the map is constant (a so-called **ghost bubble**) has at least three nodal points. This condition guarantees that limits in the SFT-topology are unique. We shall



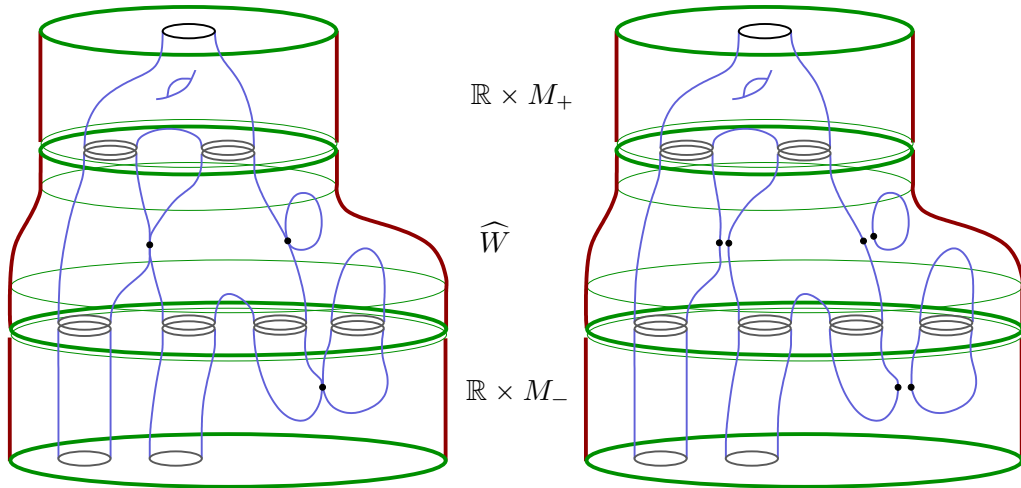

FIGURE 1. The picture at the left shows a holomorphic building with arithmetic genus two, which is broken up at the right into three maximal non-nodal subbuildings, one with arithmetic genus 1 and two with arithmetic genus 0.

generally describe a connected component of a holomorphic building as **nontrivial** if it is nonconstant and is not a trivial cylinder.

For moduli spaces of curves in a symplectization  $(\mathbb{R} \times M, J)$  with  $J \in \mathcal{J}(\mathcal{H})$ , the distinction between lower/main/upper levels is meaningless: instead, one compactifies  $\mathcal{M}(J)/\mathbb{R}$  to obtain a space  $\overline{\mathcal{M}}(J)$  of buildings with at least one and at most finitely many levels, all of them consisting of  $\mathbb{R}$ -equivalence classes of (possibly disconnected and nodal) unparametrized curves in  $\mathbb{R} \times M$ .

Within the space of holomorphic buildings, we shall sometimes make a distinction between **nontrivial buildings** and **smooth curves**: the latter means buildings that have only one level and no nodes, hence they are also elements of  $\mathcal{M}(J)$ , whereas by “nontrivial buildings” we mean everything in  $\overline{\mathcal{M}}(J) \setminus \mathcal{M}(J)$ .

Since the index of a holomorphic curve depends only on its asymptotic ends and relative homology class, the **index of a building** can be defined formally by a natural generalization of (2.7) replacing  $\dot{S}$  with  $\hat{S}$ , and in this way the index extends to a continuous  $\mathbb{Z}$ -valued function on  $\overline{\mathcal{M}}(J)$ .

For the purposes of the next statement, observe that given any building  $u$ , deleting the nodes from all levels changes  $u$  into a disjoint union of some unique collection of (not necessarily stable) connected holomorphic buildings  $u_1, \dots, u_m$ , each endowed with the extra structure of a finite set of points in their domains (the former nodal points). We shall in this case call  $u_1, \dots, u_m$  the **maximal non-nodal subbuildings** of  $u$  (see Figure 1). The relation in the following proposition is an immediate consequence of (2.7) via the observation that if  $\dot{S}$  is a surface obtained from a collection of surfaces  $\dot{S}_1, \dots, \dot{S}_m$  by performing connected sums at a set of  $N$  distinct pairs of distinct points  $\{z_j^+, z_j^-\} \subset \dot{S}_1 \amalg \dots \amalg \dot{S}_m$  for  $j = 1, \dots, N$ , then  $\chi(\dot{S}) = \sum_{i=1}^m \chi(\dot{S}_i) - 2N$ .

**Proposition 2.5.** *For any holomorphic building  $u$  in  $\widehat{W}$  with  $N \geq 0$  nodes and  $N_i \geq 0$  nodal points on each of its maximal non-nodal subbuildings  $u_i$  for  $i = 1, \dots, m$ ,*

$$\text{ind}(u) = \sum_{i=1}^m [\text{ind}(u_i) - (n-3)N_i] = \sum_{i=1}^m \text{ind}(u_i) - 2(n-3)N,$$

where  $\dim \widehat{W} = 2n$ . □

Let us specialize the above result to dimension four and consider the role played by constant components. These have no punctures but must have nodal points; setting  $n = 2$ , (2.7) implies that a constant component  $u_i$  with domain  $S$  of genus  $g$  has index  $-\chi(S) = 2g - 2$ , which is nonnegative except in the case of ghost bubbles. Stability requires however that the Euler characteristic of  $S$  should always become negative after removing nodal points, thus

$$\text{ind}(u_i) + N_i = -\chi(S) + N_i > 0.$$

This gives rise to the following corollary of Proposition 2.5:

**Proposition 2.6.** *Assume  $\dim_{\mathbb{R}} \widehat{W} = 4$  and  $u$  is a holomorphic building with  $m$  nonconstant maximal non-nodal subbuildings  $u_1, \dots, u_m$ , each with  $N_i \geq 0$  nodal points. Then*

$$\text{ind}(u) \geq \sum_{i=1}^m [\text{ind}(u_i) + N_i],$$

with equality if and only if  $u$  has no constant components. In particular, if  $u$  has arithmetic genus 0 and has at least one node, then

$$\text{ind}(u) \geq 2 + \sum_{i=1}^m \text{ind}(u_i)$$

with equality if and only if there is exactly one node and no ghost bubbles.

*Proof.* The second statement follows because in the case of arithmetic genus zero, every ghost bubble has at least three nodal points and this implies the existence of at least three nodal points on nonconstant components as well; any other scenario would lead to positive arithmetic genus. □

**2.3. Intersection theory.** In this section we summarize some useful facts from the intersection theory of asymptotically cylindrical holomorphic curves, due to Siefring [Sie11]. A more elementary introduction to this theory can also be found in [Wen20]. See also the summary given in [FS18, Section 3.3].

Assume as in §2.1 that  $\widehat{W}$  is the completion of a symplectic cobordism  $(W, \omega)$  with stable boundary  $\partial W = -M_- \amalg M_+$  carrying stable Hamiltonian structures  $\mathcal{H}_{\pm} = (\Omega_{\pm}, \Lambda_{\pm})$ , and  $J \in \mathcal{J}(\omega, \mathcal{H}_+, \mathcal{H}_-)$ . Siefring's intersection theory associates to any pair of asymptotically cylindrical (but not necessarily  $J$ -holomorphic) maps  $u$  and  $v$  into  $\widehat{W}$  with nondegenerate asymptotic orbits an intersection number

$$u * v \in \mathbb{Z},$$

which depends only on the asymptotic orbits of the two maps and their relative homology classes. It is nonnegative whenever  $u$  and  $v$  are  $J$ -holomorphic curves with non-identical images, and strictly positive whenever these have nonempty intersection. It also extends in a continuous way to the compactified moduli space of holomorphic curves as defined in [BEH<sup>+</sup>03]: one can define  $u * v$  for two holomorphic buildings, and it is additive across levels

(with extra nonnegative **breaking contributions** for common breaking orbits between two levels) and invariant under homotopies through the compactified moduli space, including “infinite  $\mathbb{R}$ -translations” which shove levels up or down or insert or delete trivial cylinders. When  $u$  and  $v$  are holomorphic curves with non-identical images,  $u * v$  counts their actual intersections (with multiplicity when they are non-transverse), in addition to a nonnegative count of **asymptotic contributions**, i.e. “hidden” intersections that can emerge from infinity under perturbations. The latter can be expressed in terms of asymptotic winding numbers: fixing a choice of complex trivialization  $\Phi$  for each of the bundles  $\Xi_{\pm} = \ker \Lambda_{\pm}$  along closed Reeb orbits, every nondegenerate Reeb orbit  $\gamma$  has certain **extremal winding numbers**

$$\alpha_{-}^{\Phi}(\gamma) \leq \alpha_{+}^{\Phi}(\gamma) \in \mathbb{Z}$$

such that by the asymptotic formula of [HWZ96], the asymptotic winding of any holomorphic curve approaching  $\gamma$  at a positive end is bounded from above by  $\alpha_{-}^{\Phi}(\gamma)$ , and at a negative end it is bounded from below by  $\alpha_{+}^{\Phi}(\gamma)$ . These are the winding numbers relative to  $\Phi$  of the so-called (positive and negative) **extremal eigenfunctions** that appear in asymptotic formulas, and they are related to the Conley-Zehnder index by the formulas

$$(2.8) \quad \begin{aligned} \mu_{\text{CZ}}^{\Phi}(\gamma) &= 2\alpha_{-}^{\Phi}(\gamma) + p(\gamma) = 2\alpha_{+}^{\Phi}(\gamma) - p(\gamma), \\ p(\gamma) &= \alpha_{+}^{\Phi}(\gamma) - \alpha_{-}^{\Phi}(\gamma) \in \{0, 1\}, \end{aligned}$$

proved in [HWZ95]. The general definition of  $u * v$  expresses it in terms of the **relative intersection number**

$$u \bullet_{\Phi} v \in \mathbb{Z},$$

which is homotopy invariant but depends on the choice of trivialization  $\Phi$  whenever  $u$  and  $v$  have asymptotic orbits in common:  $u \bullet_{\Phi} v$  is the algebraic count of intersections between  $u$  and a generic small perturbation of  $v$  that pushes it in the direction determined by  $\Phi$  at infinity. Notice that this notion is also well defined when  $u = v$  and it extends in a natural way to the case where  $u$  and  $v$  are holomorphic buildings, simply by adding relative intersection numbers across levels. The following is then a direct consequence of the definition in [Sie11] and will suffice for computing  $u * v$  in our applications:

**Lemma 2.7.** *Suppose  $u$  and  $v$  are holomorphic buildings with only positive punctures, and that for each asymptotic orbit  $\gamma$  of  $u$  or  $v$ , there exists a trivialization  $\Phi$  along the underlying simple orbit covered by  $\gamma$  such that in the induced trivialization along  $\gamma$ ,  $\alpha_{-}^{\Phi}(\gamma) = 0$ . Then  $u * v = u \bullet_{\Phi} v$ .  $\square$*

The usual adjunction formula for the closed case can now be generalized to somewhere injective punctured holomorphic curves in the form

$$(2.9) \quad u * u = 2[\delta(u) + \delta_{\infty}(u)] + c_N(u) + [\bar{\sigma}(u) - \#\Gamma].$$

Here  $\delta(u)$  is the (nonnegative) algebraic count of double points and critical points, and  $\delta_{\infty}(u)$  is an (also nonnegative) asymptotic contribution such that  $\delta(u) + \delta_{\infty}(u)$  is homotopy invariant and counts the double points of a generic perturbation of  $u$ . The **normal Chern number**  $c_N(u) \in \mathbb{Z}$  is another homotopy invariant quantity which, in the immersed case, equals the relative first Chern number of the normal bundle of  $u$  with respect to trivializations determined by the extremal eigenfunctions at the asymptotic orbits. We denote by  $\Gamma$  the set of punctures of  $u$ , and  $\bar{\sigma}(u)$  denotes the **spectral covering number**, which is the sum over all  $z \in \Gamma$  of the covering multiplicities of the relevant extremal eigenfunctions. In many applications one does

not need to compute  $\bar{\sigma}(u)$ , as it is at least immediate from the definition that  $\sigma(u) \geq \#\Gamma$ , hence (2.9) gives rise to an inequality

$$(2.10) \quad u * u \geq 2[\delta(u) + \delta_\infty(u)] + c_N(u).$$

When more precise information is needed, the following will suffice for our purposes:

**Lemma 2.8.** *Suppose  $u$  is a somewhere injective holomorphic curve with only positive punctures which satisfy the hypothesis of Lemma 2.7. Then  $\bar{\sigma}(u)$  is the sum of the covering multiplicities of the asymptotic orbits of  $u$ . In particular,  $\bar{\sigma}(u) = \#\Gamma$  whenever all asymptotic orbits are simply covered.*  $\square$

The easiest way to compute  $c_N(u)$  is usually via the Fredholm index, as it satisfies

$$(2.11) \quad 2c_N(u) = \text{ind}(u) - 2 + 2g + \#\Gamma_0,$$

where  $g \geq 0$  is the genus of the domain of  $u$  and  $\#\Gamma_0 \geq 0$  denotes the number of punctures at which the Conley-Zehnder indices of the asymptotic orbits are even. In the  $\mathbb{R}$ -invariant case  $\widehat{W} = \mathbb{R} \times M$  with  $J \in \mathcal{J}(\mathcal{H})$  for a fixed stable Hamiltonian structure  $\mathcal{H} = (\Omega, \Lambda)$ , the normal Chern number also appears in the important relation

$$(2.12) \quad 0 \leq \text{wind}_\pi(u) + \text{def}_\infty(u) = c_N(u),$$

which was originally proved by Hofer-Wysocki-Zehnder [HWZ95] and applies to any curve  $u$  that is not a cover of a trivial cylinder. Here  $\text{wind}_\pi(u) \geq 0$  is an integer which algebraically counts the non-immersed points of the projection of  $u$  to  $M$ , and  $\text{def}_\infty(u) \geq 0$  is an integer measuring the difference of the asymptotic winding at each end from the relevant extremal value  $\alpha_\pm^\Phi(\gamma)$ . We refer to [Wen10a, §4] for a fuller discussion of this relation using the same notation used here (only some of which appeared in [HWZ95]).

*Remark 2.9.* The theory defined in [Sie11] applies to any moduli spaces of asymptotically cylindrical holomorphic curves with fixed asymptotic orbits satisfying a nondegeneracy or Morse-Bott condition. One can also define a more general theory allowing moduli spaces whose asymptotic orbits move freely in Morse-Bott families—the main results of this theory are outlined in [Wen10b, §4], but we will not need this here.

In many applications, a special role is played by somewhere injective curves whose intersection-theoretic properties force them not only to be embedded but also to avoid intersecting their neighbors in the moduli space. In particular, a  $J$ -holomorphic curve  $u : \dot{S} \rightarrow \widehat{W}$  is called **nicely embedded** if it is somewhere injective and satisfies

$$\delta(u) = \delta_\infty(u) = 0 \quad \text{and} \quad u * u \leq 0.$$

This is a slight generalization of a definition that first appeared (with an extra “stability” condition) in [Wen10b]. It simplifies slightly in the  $\mathbb{R}$ -invariant case since every curve  $u$  can then be perturbed via  $\mathbb{R}$ -translation to a nearby curve, which will be different unless  $u$  is a cover of a trivial cylinder, hence  $u * u \geq 0$  always holds in such cases. The nicely embedded condition can thus be reduced in the  $\mathbb{R}$ -invariant case to

$$u * u = 0 \quad \text{or} \quad u \text{ is a trivial cylinder,}$$

as (2.12) implies in this case that  $c_N(u) \geq 0$ , so  $\delta(u) = \delta_\infty(u) = 0$  then follows from the adjunction inequality (2.10). An additional consequence of (2.12) in the  $\mathbb{R}$ -invariant case is that nicely embedded curves other than trivial cylinders satisfy  $\text{wind}_\pi(u) = \text{def}_\infty(u) = 0$ , and

the homotopy invariance of  $u * u = 0$  implies that they never intersect their own  $\mathbb{R}$ -translations, hence their projections to the 3-manifold

$$\dot{S} \xrightarrow{u} \mathbb{R} \times M \xrightarrow{\text{pr}} M$$

are embedded. Nicely embedded curves in the symplectization also satisfy a strong compactness theorem proved in [Wen10a], which we will make use of to prove uniqueness in §4.5.

The following lemma can be applied in the case  $u = v$  to characterize nicely embedded curves:

**Lemma 2.10.** *Assume  $J \in \mathcal{J}(\mathcal{H})$  for a stable Hamiltonian structure  $\mathcal{H}$  on  $M$ . For any pair of (possibly identical) connected finite energy  $J$ -holomorphic curves  $u$  and  $v$  in  $\mathbb{R} \times M$  which are not covers of trivial cylinders and have nondegenerate asymptotic orbits, we have  $u * v = 0$  whenever the following conditions hold:*

- (1) *There is no simply covered orbit  $\gamma$  with odd Conley-Zehnder index such that covers of  $\gamma$  appear at negative ends of  $u$  and positive ends of  $v$ .*
- (2) *For every negative asymptotic orbit  $\gamma$  of  $u$ ,  $v * (\mathbb{R} \times \gamma) = 0$ .*
- (3) *For every positive asymptotic orbit  $\gamma$  of  $v$ ,  $u * (\mathbb{R} \times \gamma) = 0$ .*

*Proof.* By the “infinite  $\mathbb{R}$ -translation” used in [Sie11, Lemma 5.7, Theorem 5.8], we have  $u * v = u^+ * v^-$ , where  $u^+$  and  $v^-$  are 2-level holomorphic buildings defined as follows:

- $u^+$  has  $u$  on the top level and the trivial cylinders over its negative asymptotic orbits on the bottom level,
- $v^-$  has  $v$  on the bottom level and the trivial cylinders over its positive asymptotic orbits on the top level.

To compute  $u^+ * v^-$ , we sum the respective intersection numbers of corresponding levels, together with breaking contributions, all of which are nonnegative. The top level thus contributes  $u * (\mathbb{R} \times \gamma)$  for every positive asymptotic orbit  $\gamma$  of  $v$ , and the bottom level similarly contributes  $v * (\mathbb{R} \times \gamma)$  for every negative asymptotic orbit  $\gamma$  of  $u$ . The breaking contributions come from orbits which occur as breaking orbits of both buildings, but these contributions are zero for orbits with even Conley-Zehnder index since the the eigenvectors for the largest negative eigenvalue and for the smallest positive eigenvalue of the corresponding asymptotic operator have the same winding (cf. [Wen20, Appendix C.5]).  $\square$

Intersection numbers between trivial cylinders and their own covers are usually tricky to deal with, as they need not be nonnegative in general, but they are easy at least in the following special case:

**Lemma 2.11.** *Suppose  $\gamma$  is a simply covered nondegenerate periodic orbit of  $R_{\mathcal{H}}$  in  $M$  with even Conley-Zehnder index, and  $u$  and  $v$  denote any  $J$ -holomorphic covers of the trivial cylinder  $\mathbb{R} \times \gamma$ . Then  $u * v = 0$ .*

*Proof.* Note that all covers  $\gamma^m$  of  $\gamma$  also have even Conley-Zehnder index, hence (2.8) gives  $\alpha_+^{\Phi}(\gamma^m) - \alpha_-^{\Phi}(\gamma^m) = 0$ . The result now follows directly from the definition of  $u * v$  [Sie11, Equation (2.3)].  $\square$

**2.4. Automatic transversality and coherent orientations.** We continue under the assumption that  $(W, \omega)$  is a compact symplectic cobordism with stable boundary components  $\partial W = -M_- \amalg M_+$  carrying stable Hamiltonian structures  $\mathcal{H}_{\pm} = (\Omega_{\pm}, \Lambda_{\pm})$ , and  $\widehat{W}$  denotes the completion obtained by attaching cylindrical ends. The following special case of

a transversality criterion from [Wen10b] is often useful because it requires neither genericity nor somewhere injectivity.

**Proposition 2.12.** *Assume  $J \in \mathcal{J}(\omega, \mathcal{H}_+, \mathcal{H}_-)$ ,  $\dim_{\mathbb{R}} W = 4$ , and  $u : \dot{S} \rightarrow \widehat{W}$  is an immersed finite-energy  $J$ -holomorphic curve asymptotic to nondegenerate Reeb orbits and satisfying*

$$\text{ind}(u) > c_N(u).$$

*Then  $u$  is Fredholm regular.* □

The phenomenon underlying this transversality criterion also has useful consequences for orientations of moduli spaces, in particular for spaces of dimension 0, where orienting the moduli space simply means associating a sign to each element. We shall use the coherent orientations framework described by Bourgeois and Mohnke [BM04], based on earlier work of Floer and Hofer [FH93]. Notice that by (2.11), a curve  $u$  with index 0 can satisfy  $\text{ind}(u) > c_N(u)$  only if  $c_N(u) = -1$ , in which case  $u$  must have genus 0 and all its asymptotic orbits have odd Conley-Zehnder index. The following result will play a key role in §6 for proving stability of  $J$ -holomorphic foliations under homotopies.

**Proposition 2.13.** *In the 4-dimensional setting of Proposition 2.12, suppose  $u_0$  and  $u_1$  are two immersed  $J$ -holomorphic curves with the same number of punctures and identical sets of positive and/or negative asymptotic orbits, and also satisfying*

$$\text{ind}(u_i) = 0, \quad c_N(u_i) = -1, \quad \text{for } i = 0, 1.$$

*Then any choice of coherent orientations provided by [BM04] assigns to  $u_0$  and  $u_1$  the same sign.*

Let us state a corresponding result for the  $\mathbb{R}$ -invariant setting  $(\mathbb{R} \times M, J)$  with  $J \in \mathcal{J}(\mathcal{H})$  before discussing the proofs of both. Since we usually want to consider  $\mathcal{M}(J)/\mathbb{R}$  rather than  $\mathcal{M}(J)$ , the important rigid objects in this space are represented by curves of index 1 that are not covers of trivial cylinders. The relation (2.12) implies that such curves can satisfy  $\text{ind}(u) > c_N(u)$  only if  $c_N(u) = 0$ , in which case (2.11) implies that the genus is zero and exactly one asymptotic orbit has even Conley-Zehnder index. Regular index 1 curves in  $(\mathbb{R} \times M, J)$  come in 1-dimensional moduli spaces of curves related to each other by  $\mathbb{R}$ -translation, and the  $\mathbb{R}$ -action thus induces a tautological orientation on these spaces. If a global orientation of  $\mathcal{M}(J)$  is given, one then associates a positive sign to  $[u] \in \mathcal{M}(J)/\mathbb{R}$  if the given orientation matches the tautological one induced by the  $\mathbb{R}$ -action, and a negative sign otherwise.

We must briefly recall some specifics about asymptotic eigenfunctions. If  $u : \dot{S} \rightarrow \widehat{W}$  has a positive/negative puncture  $z \in \Gamma^{\pm}$  asymptotic to a nondegenerate orbit  $\gamma$ , then the asymptotic formula of [HWZ96] and later refinements in [Mor03, Sie08] describe the approach of  $u$  to  $\gamma$  in terms of eigenfunctions of the **asymptotic operator**

$$\mathbf{A}_{\gamma} : \Gamma(\gamma^* \Xi_{\pm}) \rightarrow \Gamma(\gamma^* \Xi_{\pm}),$$

a symmetric first-order differential operator that depends only on  $\gamma$ , and whose eigenfunctions were mentioned already in §2.3. Parametrizing the trivial cylinder over  $\gamma$  as  $u_{\gamma} : \mathbb{R} \times S^1 \rightarrow \mathbb{R} \times M_{\pm} : (s, t) \mapsto (Ts, \gamma(t))$  and choosing a translation-invariant metric to define the exponential map on  $\mathbb{R} \times M_{\pm}$ , one can find coordinates  $(s, t) \in \mathbb{R}_+ \times S^1$  for the cylindrical end approaching  $z \in \Gamma^{\pm}$ , and a section  $h_z$  of  $u_{\gamma}^* \Xi_{\pm}$  such that

$$u(s, t) = \exp_{u_{\gamma}(s, t)} h_z(s, t) \quad \text{for } s \text{ close to } \pm\infty,$$

where

$$(2.13) \quad h_z(s, t) = e^{\lambda s} (e_z(t) + r_z(s, t)).$$

Here  $\lambda \in \mathbb{R}$  is an eigenvalue of  $\mathbf{A}_\gamma$  with  $\pm\lambda < 0$ ,  $e_z \in \Gamma(\gamma^*\Xi_\pm)$  is a nontrivial section belonging to the corresponding eigenspace, and  $r_z \in \Gamma(u_\gamma^*\Xi_\pm)$  is a remainder term satisfying  $|r_z(s, t)| \rightarrow 0$  uniformly as  $s \rightarrow \pm\infty$ . Let

$$V_\gamma^\pm \subset \Gamma(\gamma^*\Xi_\pm)$$

denote the eigenspace of  $\mathbf{A}_\gamma$  with the largest negative eigenvalue if  $z \in \Gamma^+$  or the smallest positive eigenvalue if  $z \in \Gamma^-$ . We then use (2.13) to define the **leading asymptotic eigenfunction**  $\text{ev}_z^\infty(u) \in V_\gamma^\pm$  of  $u$  at  $z$  by

$$\text{ev}_z^\infty(u) := \begin{cases} e_z & \text{if } e_z \in V_\gamma^\pm, \\ 0 & \text{otherwise.} \end{cases}$$

The case  $\text{ev}_z^\infty(u) = 0$  occurs if and only if the exponential decay rate in (2.13) is faster than the slowest rate allowed by the spectrum of  $\mathbf{A}_\gamma$ . As implied by the notation,  $\text{ev}_z^\infty$  can be thought of as an **asymptotic evaluation map** from the moduli space to a finite-dimensional space of eigenfunctions, and we will treat it as such in §6, cf. Lemma 6.9.

The following result can now be summarized by saying that for a pair of immersed and automatically regular index 1 curves with the same asymptotic orbits in the symplectization of a 3-manifold, their signs will match if and only if they each approach their unique even orbit “from the same side”.

**Proposition 2.14.** *Assume  $M$  is a 3-manifold with stable Hamiltonian structure  $\mathcal{H} = (\Omega, \Lambda)$ ,  $J \in \mathcal{J}(\mathcal{H})$ , and  $u_0$  and  $u_1$  are two immersed  $J$ -holomorphic curves that are not covers of trivial cylinders, have the same number of punctures and identical sets of positive and/or negative asymptotic orbits, and satisfy*

$$\text{ind}(u_i) = 1, \quad c_N(u_i) = 0, \quad \text{for } i = 0, 1.$$

Let  $e_i \in V_\gamma^\pm$  for  $i = 0, 1$  denote the leading asymptotic eigenfunction of  $u_i$  at its unique puncture asymptotic to an orbit  $\gamma$  with even Conley-Zehnder index. Then

$$e_1 = \kappa e_0 \quad \text{for some } \kappa \in \mathbb{R} \setminus \{0\},$$

and for any choice of coherent orientations provided by [BM04], the signs assigned to  $[u_0]$  and  $[u_1]$  as elements of  $\mathcal{M}(J)/\mathbb{R}$  match if and only if  $\kappa > 0$ .

Both propositions will be proved by similar arguments. To prepare for this, we need to recall a few details from [BM04] and [Wen10b]; we shall use notation consistent with the latter reference.

To any finite-energy  $J$ -holomorphic curve  $u : \dot{S} \rightarrow \widehat{W}$  with punctures  $\Gamma = \Gamma^+ \cup \Gamma^-$  positively/negatively asymptotic to Reeb orbits  $\{\gamma_z\}_{z \in \Gamma}$ , one can associate a Fredholm operator

$$\mathbf{D}_u : W^{1,p,\delta}(u^*T\widehat{W}) \oplus V_\Gamma \rightarrow L^{p,\delta}(\overline{\text{Hom}}_{\mathbb{C}}(T\dot{S}, u^*T\widehat{W})),$$

called the **linearized Cauchy-Riemann operator** at  $u$ . Here  $p > 2$ , and  $W^{1,p,\delta}(u^*T\widehat{W})$  denotes the Banach space of Sobolev class  $W^{1,p}$  sections  $\eta$  of  $u^*T\widehat{W}$  satisfying the exponential decay condition  $e^{\delta s}\eta \in W^{1,p}([0, \infty) \times S^1)$  in holomorphic cylindrical coordinates  $(s, t) \in [0, \infty) \times S^1$  near each puncture, where  $\delta > 0$  is a small constant. The space  $V_\Gamma \subset \Gamma(u^*T\widehat{W})$  is of

dimension  $2\#\Gamma$  and consists of smooth sections that are constant near infinity in a suitable choice of trivialization. Since  $\mathbf{D}_u$  is Fredholm, it has a determinant line

$$\det(\mathbf{D}_u) = \Lambda^{\max} \ker \mathbf{D}_u \otimes (\Lambda^{\max} \operatorname{coker} \mathbf{D}_u)^*.$$

The asymptotic form of  $\mathbf{D}_u$  near each puncture  $z \in \Gamma^\pm$  is determined by the asymptotic operator  $\mathbf{A}_{\gamma_z}$ . The procedure of [BM04] for defining orientations is then to orient the determinant line bundles over the topological spaces of isomorphism classes of Cauchy-Riemann type Fredholm operators of the above form with fixed asymptotic operators at the punctures. This is done so as to make the orientations compatible with certain linear gluing operations, so that the resulting orientations are called *coherent*. They give rise to orientations for spaces of  $J$ -holomorphic curves in the following way. If  $u : (\dot{S}, j) \rightarrow (\widehat{W}, J)$  is Fredholm regular, then the implicit function theorem gives the moduli space  $\mathcal{M}(J)$  of unparametrized  $J$ -holomorphic curves the structure of a smooth orbifold of dimension  $\operatorname{ind}(u)$  near  $u$ , with its tangent space at  $u$  identified with

$$(2.14) \quad T_u \mathcal{M}(J) = \ker D\bar{\partial}_J(j, u) / \operatorname{aut}(\dot{S}, j).$$

Here  $D\bar{\partial}_J(j, u)$  denotes the linearization of the **nonlinear Cauchy-Riemann operator**

$$\bar{\partial} : \mathcal{T} \times \mathcal{B} \rightarrow \mathcal{E} : (j, u) \mapsto Tu + J(u) \circ Tu \circ j,$$

where  $\mathcal{B}$  is a Banach manifold of  $W^{1,p}$ -smooth maps  $\dot{S} \rightarrow \widehat{W}$  whose tangent space at  $u$  is the domain of  $\mathbf{D}_u$ ,  $\mathcal{T}$  is a smooth family of complex structures on  $\dot{S}$  parametrizing a neighborhood of  $[j]$  in Teichmüller space, and  $\mathcal{E} \rightarrow \mathcal{T} \times \mathcal{B}$  is a smooth Banach space bundle whose fiber over  $(j, u)$  is the target space of  $\mathbf{D}_u$ . The space  $\operatorname{aut}(\dot{S}, j)$  is the Lie algebra of the automorphism group of  $(\dot{S}, j)$ , which embeds into  $\ker D\bar{\partial}(j, u)$  via the map taking vector fields  $X$  on  $\dot{S}$  to sections  $Tu(X)$  of  $u^*T\widehat{W}$ . Since  $\operatorname{aut}(\dot{S}, j)$  is naturally a complex vector space, any orientation of  $\ker D\bar{\partial}_J(j, u)$  gives rise to an orientation of  $T_u \mathcal{M}(J)$ , thus it suffices to orient the determinant line of  $D\bar{\partial}(j, u)$ , which is equivalent to orienting its kernel since  $D\bar{\partial}(j, u)$  is assumed surjective in the Fredholm regular case. This operator takes the form

$$\mathbf{L}_{j,u} := D\bar{\partial}(j, u) : T_j \mathcal{T} \oplus T_u \mathcal{B} \rightarrow \mathcal{E}_{(j,u)} : (y, \eta) \mapsto \mathbf{D}_u \eta + J(u) \circ Tu \circ y.$$

Any continuous family of  $J$ -holomorphic curves gives rise to a continuous family of Fredholm operators of this form, all of which can be retracted through Fredholm operators to the corresponding linearized Cauchy-Riemann operators via the homotopy

$$(2.15) \quad \mathbf{L}_{j,u}^s(y, \eta) := \mathbf{D}_u \eta + s J(u) \circ Tu \circ y, \quad s \in [0, 1].$$

Taking  $s = 0$ , we have  $\ker \mathbf{L}_{j,u}^0 = T_j \mathcal{T} \oplus \ker \mathbf{D}_u$  and  $\operatorname{coker} \mathbf{L}_{j,u}^0 = \operatorname{coker} \mathbf{D}_u$ . Since Teichmüller space is also naturally complex,  $T_j \mathcal{T}$  has a canonical orientation, so that the orientation of  $\det(\mathbf{D}_u)$  defined in [BM04] induces an orientation of  $\det(\mathbf{L}_{j,u}^0)$ , and we use the homotopy  $\{\mathbf{L}_{j,u}^s\}_{s \in [0,1]}$  to define from this an orientation of  $\det(\mathbf{L}_{j,u}^1)$ , therefore orienting  $T_u \mathcal{M}(J)$ .

Recall now from [Wen10b] that if  $u : \dot{S} \rightarrow \widehat{W}$  is immersed and  $N_u \rightarrow \dot{S}$  denotes its normal bundle, the natural complex bundle splitting  $u^*T\widehat{W} = T\dot{S} \oplus N_u$  decomposes  $\mathbf{D}_u$  in block form as

$$(2.16) \quad \mathbf{D}_u = \begin{pmatrix} \mathbf{D}_u^T & \mathbf{D}_u^{NT} \\ 0 & \mathbf{D}_u^N \end{pmatrix},$$

where  $\mathbf{D}_u^T$  and  $\mathbf{D}_u^N$  are real-linear Cauchy-Riemann type operators on  $T\dot{S}$  and  $N_u$  respectively, and the latter is called the **normal Cauchy-Riemann operator** of  $u$ . We can extend the



splitting  $u^*T\widehat{W} = T\dot{S} \oplus N_u$  over the circle compactification of the end near each puncture  $z \in \Gamma^\pm$  so that  $N_u$  at the end is identified with  $\gamma_z^*\Xi_\pm$  and  $T\dot{S}$  is identified with the trivial complex subbundle generated by  $\mathbb{R}$  and the Reeb vector field. The space  $V_\Gamma$  can then be chosen as a space of sections of  $T\dot{S}$ , and  $\mathbf{D}_u^T$  identified with the *standard* Cauchy-Riemann operator on  $\dot{S}$ ,

$$\mathbf{D}_{(\dot{S},j)} : W^{1,p,\delta}(T\dot{S}) \oplus V_\Gamma \rightarrow L^{p,\delta}(\overline{\text{End}}_{\mathbb{C}}(T\dot{S})),$$

i.e. the linearization at the identity of the nonlinear Cauchy-Riemann operator for asymptotically cylindrical holomorphic maps  $(\dot{S}, j) \rightarrow (\dot{S}, j)$ . The cokernel of this operator has a natural identification with the tangent space to Teichmüller space, so one can always assume that the map

$$(2.17) \quad \begin{aligned} T_j\mathcal{T} \oplus \left( W^{1,p,\delta}(T\dot{S}) \oplus V_\Gamma \right) &\rightarrow L^{p,\delta}(\overline{\text{End}}_{\mathbb{C}}(T\dot{S})) \\ (y, X) &\mapsto jy + \mathbf{D}_{(\dot{S},j)}X \end{aligned}$$

is surjective. Writing a section of  $u^*T\widehat{W} = T\dot{S} \oplus N_u$  as  $(X, \eta)$ , this gives a decomposition of  $\mathbf{L}_{j,u} = D\bar{\partial}_J(j, u)$  as

$$(2.18) \quad \mathbf{L}_{j,u}(y, X, \eta) = \left( jy + \mathbf{D}_{(\dot{S},j)}X + \mathbf{D}_u^{NT}\eta, \mathbf{D}_u^N\eta \right),$$

showing that  $\mathbf{L}_{j,u}$  is surjective if and only if  $\mathbf{D}_u^N$  is surjective. Note also that  $\ker \mathbf{D}_{(\dot{S},j)}$  is naturally isomorphic to  $\mathfrak{aut}(\dot{S}, j)$ , so injecting the latter into  $\ker \mathbf{L}_{j,u}$  as the subspace  $\{0\} \oplus \ker \mathbf{D}_{(\dot{S},j)} \oplus \{0\}$  and using (2.14), we obtain from this expression a natural isomorphism

$$(2.19) \quad T_u\mathcal{M}(J) = \ker \mathbf{L}_{j,u} / \ker \mathbf{D}_{(\dot{S},j)} \rightarrow \ker \mathbf{D}_u^N : [(y, X, \eta)] \mapsto \eta.$$

*Proof of Proposition 2.13.* Assume  $u_0$  and  $u_1$  are as stated in the proposition. Since (2.11) implies that both have genus zero, their domains are diffeomorphic, and  $\text{ind}(u_0) = \text{ind}(u_1) = 0$  implies that the complex line bundles  $N_{u_0}$  and  $N_{u_1}$  also admit a bundle isomorphism that is asymptotic to their canonical identification at the ends. Let us assume first for simplicity that  $u_0$  and  $u_1$  have isomorphic conformal structures on their domains, so we can represent them by the same complex structure  $j$  on  $\dot{S}$  and fix a single slice  $\mathcal{T}$  parametrizing the Teichmüller space near  $[j]$ . Then after identifying both  $N_{u_0}$  and  $N_{u_1}$  with some fixed complex line bundle  $E \rightarrow \dot{S}$ , we can assume  $\mathbf{D}_0^N := \mathbf{D}_{u_0}^N$  and  $\mathbf{D}_1^N := \mathbf{D}_{u_1}^N$  are Cauchy-Riemann type operators on the same bundle over the same domain

$$\mathbf{D}_i^N : W^{1,p,\delta}(E) \rightarrow L^{p,\delta}(\overline{\text{Hom}}_{\mathbb{C}}(T\dot{S}, E)), \quad i = 0, 1,$$

and these are related to  $\mathbf{D}_i := \mathbf{D}_{u_i}$  and  $\mathbf{L}_i := \mathbf{L}_{j,u_i}$  for  $i = 0, 1$  as in (2.16) and (2.18) respectively. Now since the space of Cauchy-Riemann type operators with fixed asymptotic orbits is affine, we can choose a homotopy  $\{\mathbf{D}_\tau^N\}_{\tau \in [0,1]}$  from  $\mathbf{D}_0^N$  to  $\mathbf{D}_1^N$ , which induces homotopies  $\{\mathbf{D}_\tau\}$  from  $\mathbf{D}_0$  to  $\mathbf{D}_1$  and  $\{\mathbf{L}_\tau\}$  from  $\mathbf{L}_0$  to  $\mathbf{L}_1$ . By [Wen10b, Proposition 2.2], the operators  $\mathbf{D}_\tau^N$  are always surjective, hence so are  $\mathbf{L}_\tau$ . Since  $\text{ind}(u_0) = \text{ind}(u_1) = 0$ , the kernel of  $\mathbf{L}_\tau$  is therefore identical to the subspace  $\mathfrak{aut}(\dot{S}, j)$  for every  $\tau \in [0, 1]$ .

Now suppose a choice of coherent orientations as constructed in [BM04] is given. This assigns a continuously varying orientation to the determinant of  $\mathbf{D}_\tau$  for each  $\tau \in [0, 1]$ . In order to determine whether  $u_0$  and  $u_1$  have the same sign, one must consider the determinant line bundle over a 1-parameter family of Fredholm operators from  $\mathbf{L}_0$  to  $\mathbf{L}_1$  constructed in three parts:

- (1) Retract  $\mathbf{L}_0$  to  $0 + \mathbf{D}_0$  as in (2.15);
- (2) Follow the homotopy  $\mathbf{D}_\tau$  from  $\mathbf{D}_0$  to  $\mathbf{D}_1$ ;
- (3) Unretract from  $0 + \mathbf{D}_1$  to  $\mathbf{L}_1$ , again as in (2.15).

The retractions for  $i = 0, 1$  transfer the given orientations of  $\det(\mathbf{D}_i)$  to orientations of  $\det \mathbf{L}_i = \Lambda^{\max} \ker \mathbf{L}_i$ , and the sign of  $u_i$  depends on whether the latter orientations match the canonical orientation of  $\mathbf{aut}(\dot{S}, j)$  as a complex vector space. (Note that if  $\mathbf{aut}(\dot{S}, j)$  is trivial, then it means the  $\mathbf{L}_i$  are isomorphisms, so that  $\det(\mathbf{L}_i)$  is tautologically equal to  $\mathbb{R}$  and the sign of  $u_i$  depends on whether the induced orientation of  $\mathbb{R}$  matches the tautological one.) Since the orientations of  $\det(\mathbf{D}_\tau)$  must be continuous in  $\tau$ , following the three-part homotopy from  $\mathbf{L}_0$  to  $\mathbf{L}_1$  therefore determines the relationship between the signs of  $u_0$  and  $u_1$ . We notice however that the retraction from  $\mathbf{L}_\tau$  to  $0 + \mathbf{D}_\tau$  can also be performed for every  $\tau \in [0, 1]$ , hence the three-part homotopy can be deformed with fixed endpoints to  $\{\mathbf{L}_\tau\}_{\tau \in [0, 1]}$ . The latter is a homotopy through surjective operators, and for any continuous family of orientations of  $\ker \mathbf{L}_\tau$ , either all or none of them match the orientation of  $\mathbf{aut}(\dot{S}, j)$ . This proves that the signs of  $u_0$  and  $u_1$  are equal as claimed.

If  $u_0$  and  $u_1$  have inequivalent conformal structures  $j_0$  and  $j_1$  on their domains, then the above argument must be supplemented by an initial step choosing a continuous deformation of Cauchy-Riemann type operators to accompany a deformation from  $j_0$  to  $j_1$  in the space of complex structures and a simultaneous deformation of the corresponding Teichmüller slices. This can always be done since the space of complex structures on  $\dot{S}$  compatible with its orientation is contractible. The key point is that [Wen10b, Prop. 2.2] always guarantees surjectivity for the restriction of the Cauchy-Riemann type operators to a line bundle isomorphic to  $N_{u_0}$  with the same asymptotic operators.  $\square$

*Proof of Proposition 2.14.* Most steps are the same as for Prop. 2.13, so let us merely clarify the differences. The normal operators  $\mathbf{D}_\tau^N$  now have index 1 and have 1-dimensional kernels since [Wen10b, Prop. 2.2] again implies that they are always surjective. The normal Chern number  $c_N(u_0) = c_N(u_1) = 0$  can in this case be interpreted as the relative first Chern number of  $E \rightarrow \dot{S}$  with respect to the asymptotic trivializations that determine the extremal winding for holomorphic sections, hence the nontrivial elements  $\eta \in \ker \mathbf{D}_\tau^N$  are guaranteed to be nowhere zero and to have extremal winding at every end (cf. [Wen10b, §2.2]). Let  $z \in \Gamma^\pm$  denote the unique puncture for both  $u_0$  and  $u_1$  at which the asymptotic orbit  $\gamma$  has even Conley-Zehnder index. The extremal eigenspace  $V_\gamma^\pm$  is then 1-dimensional as a consequence of (2.8) since by [HWZ95], exactly two eigenvalues of  $\mathbf{A}_\gamma$  counting multiplicity have eigenfunctions with any given winding. The extremal winding condition thus implies that any nontrivial  $\eta \in \ker \mathbf{D}_\tau^N$  has a nontrivial asymptotic eigenfunction in  $V_\gamma^\pm$  at the puncture  $z$ . A continuous family of such sections for  $\tau \in [0, 1]$  therefore determines a continuous path in  $V_\gamma^\pm \setminus \{0\}$ .

Since  $0 \leq \text{def}_\infty(u_i) \leq c_N(u_i) = 0$  for  $i = 0, 1$  by (2.12), the leading asymptotic eigenfunctions  $e_i \in V_\gamma^\pm$  of  $u_i$  at  $z$  are also nonzero. Let  $\eta_i \in \ker \mathbf{D}_i^N$  for  $i = 0, 1$  denote the canonical generators that are identified via (2.19) with the infinitesimal generator of the  $\mathbb{R}$ -translation action on  $u_i$ . The asymptotic formula (2.13) implies that these have asymptotic eigenfunctions at  $z$  of the form  $\kappa_i e_i \in V_\gamma^\pm$  for some constants  $\kappa_i > 0$ . Hence there exists a continuous family  $\{\eta_\tau\}_{\tau \in [0, 1]}$  of nontrivial generators of  $\ker \mathbf{D}_\tau^N$  connecting  $\eta_0$  to  $\eta_1$  if and only if  $e_0$  and  $e_1$  are positive multiples of one another.

With this understood, the signs of  $[u_i] \in \mathcal{M}(J)/\mathbb{R}$  for  $i = 0, 1$  are determined as follows. The retractions as in (2.15) from  $\mathbf{L}_i$  to  $0 + \mathbf{D}_i$  transfer the given orientation of  $\det(\mathbf{D}_i)$  to an orientation of  $\det(\mathbf{L}_i) = \Lambda^{\max} \ker \mathbf{L}_i$ , hence orienting  $\ker \mathbf{L}_i$ . Dividing the latter by the canonically oriented subspace  $\mathbf{aut}(\dot{S}, j)$  and using (2.19) then induces an orientation of the 1-dimensional space  $\ker \mathbf{D}_i^N$ , for which  $\eta_i$  is either positive or negative, so this is the sign of  $[u_i]$ . To relate these signs to each other, one follows the orientations along the “three-part homotopy” of Fredholm operators described in the proof of Prop. 2.13, which is again homotopic to a path  $\mathbf{L}_\tau$  consisting of surjective operators with kernels isomorphic to  $\mathbf{aut}(\dot{S}, j) \oplus \ker \mathbf{D}_\tau^N$ . One therefore obtains the same sign for  $[u_0]$  and  $[u_1]$  if and only if there exists a path  $\{\eta_\tau\}$  of generators of  $\ker \mathbf{D}_\tau^N$  as described in the previous paragraph, which reduces to the question of whether  $e_0$  and  $e_1$  lie in the same component of  $V_\gamma^\pm \setminus \{0\}$ .  $\square$

### 3. A SYMPLECTIC MODEL OF A CYLINDRICAL END

Throughout this section, assume  $(M, \xi)$  is a closed connected contact 3-manifold on which  $\xi$  is supported by a spinal open book

$$\pi := \left( \pi_\Sigma : M_\Sigma \rightarrow \Sigma, \pi_P : M_P \rightarrow S^1 \right).$$

The purpose of this section is to construct a symplectic and almost complex model of the half-symplectization  $[0, \infty) \times M$  of  $(M, \xi)$ , designed such that given any hypothetical symplectic filling  $(W, \omega)$  of  $(M, \xi)$ , we can define a symplectic completion of  $(W, \omega)$  that contains an abundance of pseudoholomorphic curves. The construction is an extension of the model collar neighborhood described in [LVW, §4], which views  $(M, \xi)$  as a smoothing of the boundary (with corners) of a noncompact 4-manifold  $E$  whose boundary has two smooth faces

$$\partial E = \partial_v E \cup \partial_h E,$$

interpreted as the vertical and horizontal boundaries respectively of a (locally defined) symplectic fibration. Here it is not necessary to assume  $(M, \xi)$  admits a symplectic filling, as we can instead identify it with the contact-type boundary of a collar neighborhood  $(-1, 0] \times M$  in its own symplectization. By attaching cylindrical ends to the fibers of the aforementioned fibration and also extending it over cylindrical ends attached to the base, one obtains the *double completion*  $\widehat{E}$ , which contains  $E$  as a bounded subdomain. We will endow  $\widehat{E}$  with a Liouville structure  $\lambda$  and compatible almost complex structure  $J_+$  having the following properties:

- (1)  $J_+$  admits a suitable exhausting  $J_+$ -convex function and thus defines almost Stein structures on suitable subdomains of  $\widehat{E}$ , homotopic to the Liouville structure  $\lambda$ ;
- (2) The corner in  $\partial E$  can be smoothed to produce a contact hypersurface contactomorphic to  $(M, \xi)$ ;
- (3) A neighborhood of infinity in  $\widehat{E}$  can be identified with the half-symplectization  $[0, \infty) \times M$  of a suitable stable Hamiltonian structure  $\mathcal{H}$  on  $M$ , with  $J_+ \in \mathcal{J}(\mathcal{H})$ ;
- (4) The symplectization  $\mathbb{R} \times M$  of the aforementioned stable Hamiltonian structure admits a foliation by embedded  $J_+$ -holomorphic curves that project to  $M_P$  as the pages of  $\pi$ ;
- (5)  $\widehat{E}$  also contains embedded  $J_+$ -holomorphic curves that intersect the holomorphic pages transversely and project to  $M_\Sigma$  as sections of  $\pi_\Sigma : M_\Sigma \rightarrow \Sigma$ , i.e. “holomorphic vertebrae”.

Since it is only semi-standard, we recall the following definition from [LVW, §1.1] of a geometric structure that is intermediate between Stein and Weinstein structures.

**Definition 3.1.** An **almost Stein structure**  $(J, f)$  on a smooth compact oriented manifold  $W$  with boundary and corners consists of an almost complex structure  $J : TW \rightarrow TW$  and smooth function  $f : W \rightarrow \mathbb{R}$  such that  $\lambda := -df \circ J$  is a Liouville form with  $J$  tamed by  $d\lambda$ , and  $\lambda$  restricts to a positive contact form on every smooth face of  $\partial W$ . (Note that we do not require  $f|_{\partial W}$  to be constant since  $\partial W$  may have corners, but it is automatic that the Liouville vector field dual to  $\lambda$  is gradient-like for  $f$  and outwardly transverse to every face of  $\partial W$ .)

It will be immediate that the construction outlined above can also be modified by replacing the symplectic form  $d\lambda$  with  $C d\lambda + \eta$  for any closed 2-form  $\eta$  and a sufficiently large constant  $C > 0$ ; this makes the smoothing of  $\partial E$  a *weakly* contact hypersurface, and makes it possible to attach the model on top of weak fillings of  $(M, \xi)$ . We will see that this trick only interferes with the construction of the stable Hamiltonian structure and resulting  $J_+$ -holomorphic curves if the symplectic structure is non-exact on the spine, so when this is not the case, we obtain nontrivial moduli spaces in completions of weak fillings and will use them in §6 for the proofs of Theorems 1.5, 1.10 and 1.13. After explaining the construction of the stable Hamiltonian structure and holomorphic curves in §3, it will be the purpose of §4 to extend the construction to the case  $\partial M \neq \emptyset$ , and then to show that the data on  $M$  can be perturbed to a contact structure isotopic to  $\xi$  and to explore the consequences of this. For genus zero pages, the perturbation results in a finite energy foliation just as for planar open books (cf. [Wen10d]), and this foliation will be used in §5 to prove Theorems 1.17, 1.18 and 1.19.

*Remark 3.2.* Some higher-dimensional analogues of the double completion model (inspired by an earlier draft of the present paper) appear in [Mor18, Mora, Morb].

**3.1. Collar neighborhoods and smoothed hypersurfaces.** We will need to use the following notation originating in [LVW, §2.2].

We denote collar neighborhoods of the boundaries in  $\Sigma$ ,  $M_\Sigma$  and  $M_P$  by  $\mathcal{N}(\partial\Sigma) \cong (-1, 0] \times \partial\Sigma$ ,  $\mathcal{N}(\partial M_\Sigma) \cong (-1, 0] \times \partial M_\Sigma$  and  $\mathcal{N}(\partial M_P) \cong (-1, 0] \times \partial M_P$  respectively, where it is assumed that  $\pi_\Sigma^{-1}(\mathcal{N}(\partial\Sigma)) = \mathcal{N}(\partial M_\Sigma)$ , and a trivialization of  $\pi_\Sigma : M_\Sigma \rightarrow \Sigma$  has been fixed so as to identify  $\mathcal{N}(\partial M_\Sigma)$  with  $\mathcal{N}(\partial\Sigma) \times S^1$ . Fixing an identification of each component of  $\partial\Sigma$  with  $S^1$  then determines coordinates

$$(s, \phi) \in (-1, 0] \times S^1 \subset (-1, 0] \times \partial\Sigma = \mathcal{N}(\partial\Sigma) \subset \Sigma,$$

$$(s, \phi, \theta) \in (-1, 0] \times S^1 \times S^1 \subset (-1, 0] \times \partial M_\Sigma = \mathcal{N}(\partial M_\Sigma) \subset M_\Sigma,$$

which satisfy  $\pi_\Sigma(s, \phi, \theta) = (s, \phi) \in \mathcal{N}(\partial\Sigma)$  on  $\mathcal{N}(\partial M_\Sigma)$ . Making suitable choices of collar coordinates  $(t, \theta) \in (-1, 0] \times S^1$  near the boundary of a fiber of  $\pi_P : M_P \rightarrow S^1$  and adjusting the monodromy  $\mu$  by an isotopy so that  $\mu(t, \theta) = (t, \theta)$  in these coordinates (but allowing a permutation of boundary components), we also identify each component of  $\mathcal{N}(\partial M_P)$  with  $S^1 \times (-1, 0] \times S^1$  and thus define coordinates

$$(\phi, t, \theta) \in S^1 \times (-1, 0] \times S^1 \subset \mathcal{N}(\partial M_P) \subset M_P$$

in which

$$(3.1) \quad \pi_P(\phi, t, \theta) = m\phi \in S^1 \quad \text{on} \quad S^1 \times (-1, 0] \times S^1 \subset \mathcal{N}(\partial M_P)$$

for some  $m \in \mathbb{N}$ . Here  $m$  is the *multiplicity* of  $\pi_P$  at the adjacent boundary component of the spine (see Definition 1.2), and it may have distinct values on different connected components of  $\mathcal{N}(\partial M_P)$ . The coordinates defined on  $\mathcal{N}(\partial M_\Sigma)$  and  $\mathcal{N}(\partial M_P)$  should be assumed consistent with each other in the sense that the respective  $\phi$ - and  $\theta$ -coordinates match each other on  $\partial M_\Sigma = \partial M_P$ .

The model collar neighborhood of  $M \subset (-1, 0] \times M$  was defined in [LVW, §4.1] as

$$E := ((-1, 0] \times M_\Sigma) \cup_\Phi ((-1, 0] \times M_P),$$

where  $(-1, 0] \times \mathcal{N}(\partial M_\Sigma)$  is glued to  $(-1, 0] \times \mathcal{N}(\partial M_P)$  via the diffeomorphism

$$(-1, 0] \times \overbrace{(-1, 0] \times \partial M_\Sigma}^{\mathcal{N}(\partial M_\Sigma)} \xrightarrow{\Phi} (-1, 0] \times \overbrace{(-1, 0] \times \partial M_P}^{\mathcal{N}(\partial M_P)} : (t, s, x) \mapsto (s, t, x)$$

for  $x \in \partial M_\Sigma = \partial M_P$ . This object is depicted as the more darkly shaded region in Figure 2, along with the vertical and horizontal boundaries

$$\partial_v E := \{0\} \times M_P \subset E, \quad \partial_h E := \{0\} \times M_\Sigma \subset E,$$

and their respective collar neighborhoods

$$\mathcal{N}(\partial_v E) := (-1, 0] \times M_P \subset E, \quad \mathcal{N}(\partial_h E) := (-1, 0] \times M_\Sigma \subset E,$$

whose intersection (a neighborhood of the corner  $\partial_v E \cap \partial_h E$ ) we sometimes denote by

$$\mathcal{N}(\partial_v E \cap \partial_h E) := \mathcal{N}(\partial_v E) \cap \mathcal{N}(\partial_h E) \subset E.$$

The definition of the gluing map  $\Phi$  gives rise to well-defined coordinates

$$(s, \phi, t, \theta) \in (-1, 0] \times S^1 \times (-1, 0] \times S^1 \subset \mathcal{N}(\partial_v E \cap \partial_h E)$$

on each component of  $\mathcal{N}(\partial_v E \cap \partial_h E)$ .

On the collars  $\mathcal{N}(\partial_h E)$  and  $\mathcal{N}(\partial_v E)$  there are natural fibrations

$$\begin{aligned} \mathcal{N}(\partial_h E) &= (-1, 0] \times (\Sigma \times S^1) \xrightarrow{\Pi_h} \Sigma : (t, (z, \theta)) \mapsto \pi_\Sigma(z, \theta) = z, \\ \mathcal{N}(\partial_v E) &= (-1, 0] \times M_P \xrightarrow{\Pi_v} (-1, 0] \times S^1 : (s, x) \mapsto (s, \pi_P(x)), \end{aligned}$$

which can be written in the coordinates  $(s, \phi, t, \theta)$  on  $\mathcal{N}(\partial_v E \cap \partial_h E)$  as

$$(3.2) \quad \Pi_h(s, \phi, t, \theta) = (s, \phi) \in \mathcal{N}(\partial \Sigma), \quad \Pi_v(s, \phi, t, \theta) = (s, m\phi) \in (-1, 0] \times S^1.$$

Since the fibers of these two fibrations match on the region of overlap, they give rise to a well-defined **vertical subbundle**

$$VE := \ker T\Pi_h \text{ or } \ker T\Pi_v \subset TE,$$

which on  $\mathcal{N}(\partial_h E)$  is spanned by the vector fields  $\partial_t$  and  $\partial_\theta$ . Figure 2 is drawn so that the fibers would be represented as vertical lines in the picture.

Observe that in light of the canonical identifications  $\partial_v E = M_P$  and  $\partial_h E = M_\Sigma$ , the boundary  $\partial E = \partial_v E \cup \partial_h E$  has a canonical identification with  $M = M_P \cup M_\Sigma$ , though it cannot be regarded as a smooth submanifold due to the corner at  $\partial_v E \cap \partial_h E$ . We can however smooth the corner to define a smooth hypersurface diffeomorphic to  $M$ . Specifically, choose a pair of smooth functions  $F, G : (-1, 1) \rightarrow (-1, 0]$  that satisfy the following conditions:

- $(F(\rho), G(\rho)) = (\rho, 0)$  for  $\rho \leq -1/4$ ;
- $(F(\rho), G(\rho)) = (0, -\rho)$  for  $\rho \geq 1/4$ ;
- $G'(\rho) < 0$  for  $\rho > -1/4$ ;
- $F'(\rho) > 0$  for  $\rho < 1/4$ .

Now let

$$M^0 \subset E$$

denote the smooth hypersurface obtained from  $\partial E$  by replacing  $\partial E \cap \mathcal{N}(\partial_v E \cap \partial_h E)$  in  $(s, \phi, t, \theta)$ -coordinates with

$$(3.3) \quad \left\{ (F(\rho), \phi, G(\rho), \theta) \mid \phi, \theta \in S^1, -1 < \rho < 1 \right\};$$

see Figure 2. We shall present  $M^0$  as the union of three open subsets

$$M^0 = \widetilde{M}_P^0 \cup \widetilde{M}_T^0 \cup \widetilde{M}_\Sigma^0,$$

defined as follows (see Figure 3):

- $\widetilde{M}_P^0$  is the complement of  $\{t \geq -1/2\} \subset \mathcal{N}(\partial M_P)$  in  $\partial_v E$ .
- $\widetilde{M}_\Sigma^0$  is the complement of  $\{s \geq -1/2\}$  in  $\partial_h E$ .
- $\widetilde{M}_T^0$  is the smoothing region (3.3), each of whose connected components carry a positively oriented coordinate system  $(\rho, \phi, \theta)$  identifying it with  $(-1, 1) \times S^1 \times S^1$ .

The portion of  $\widetilde{M}_P^0$  intersecting  $\widetilde{M}_T^0$  carries coordinates  $(\phi, t, \theta)$  that identify its connected components with  $S^1 \times (-1, -1/2) \times S^1$  and are related to the coordinates on  $\widetilde{M}_T^0$  by  $\rho = -t$ . Similarly, the overlap of  $\widetilde{M}_\Sigma^0$  with  $\widetilde{M}_T^0$  carries coordinates  $(s, \phi, \theta)$  that identify its components with  $(-1, -1/2) \times S^1 \times S^1$  and satisfy  $s = \rho$ .

It will also be convenient to define a second hypersurface

$$M^- \subset E$$

by translating  $M^0$  a distance of  $-3/4$  in both the  $s$ - and  $t$ -coordinates; see Figure 2. This contains portions of the two hypersurfaces  $\{-3/4\} \times M_\Sigma \subset \mathcal{N}(\partial_h E)$  and  $\{-3/4\} \times M_P \subset \mathcal{N}(\partial_v E)$  and a translated copy of (3.3) replacing the neighborhood of their intersection.

**3.2. The double completion.** The collar neighborhoods  $\mathcal{N}(\partial\Sigma) \subset \Sigma$ ,  $\mathcal{N}(\partial M_\Sigma) \subset M_\Sigma$  and  $\mathcal{N}(\partial M_P) \subset M_P$  give rise to *completions*, constructed in each case by attaching cylindrical ends and extending the coordinate  $s$  or  $t$  to take values in  $(-1, \infty)$ : we shall indicate each of these completions by placing hats over the relevant symbol, hence

$$\begin{aligned} \widehat{\Sigma} &:= \Sigma \cup_{\partial\Sigma} ([0, \infty) \times \partial\Sigma), \\ \widehat{M}_\Sigma &:= M_\Sigma \cup_{\partial M_\Sigma} ([0, \infty) \times \partial M_\Sigma), \\ \widehat{M}_P &:= M_P \cup_{\partial M_P} ([0, \infty) \times \partial M_P), \end{aligned}$$

and the collars become cylindrical ends whose components have coordinates

$$\begin{aligned} (s, \phi) &\in (-1, \infty) \times S^1 \subset (-1, \infty) \times \partial\Sigma =: \widehat{\mathcal{N}}(\partial\Sigma) \subset \widehat{\Sigma}, \\ (s, \phi, \theta) &\in (-1, \infty) \times S^1 \times S^1 \subset (-1, \infty) \times \partial M_\Sigma =: \widehat{\mathcal{N}}(\partial M_\Sigma) \subset \widehat{M}_\Sigma, \\ (\phi, t, \theta) &\in S^1 \times (-1, \infty) \times S^1 \subset (-1, \infty) \times \partial M_P =: \widehat{\mathcal{N}}(\partial M_P) \subset \widehat{M}_P. \end{aligned}$$

We will continue to denote by  $\pi_\Sigma$  and  $\pi_P$  the natural extensions of the fibrations to  $\widehat{M}_\Sigma = \widehat{\Sigma} \times S^1 \rightarrow \widehat{\Sigma}$  and  $\widehat{M}_P \rightarrow S^1$  respectively. The **double completion**  $\widehat{E}$  of  $E$  is defined as

$$\widehat{E} := ((-1, \infty) \times \widehat{M}_\Sigma) \cup_{\widehat{\mathfrak{F}}} ((-1, \infty) \times \widehat{M}_P),$$

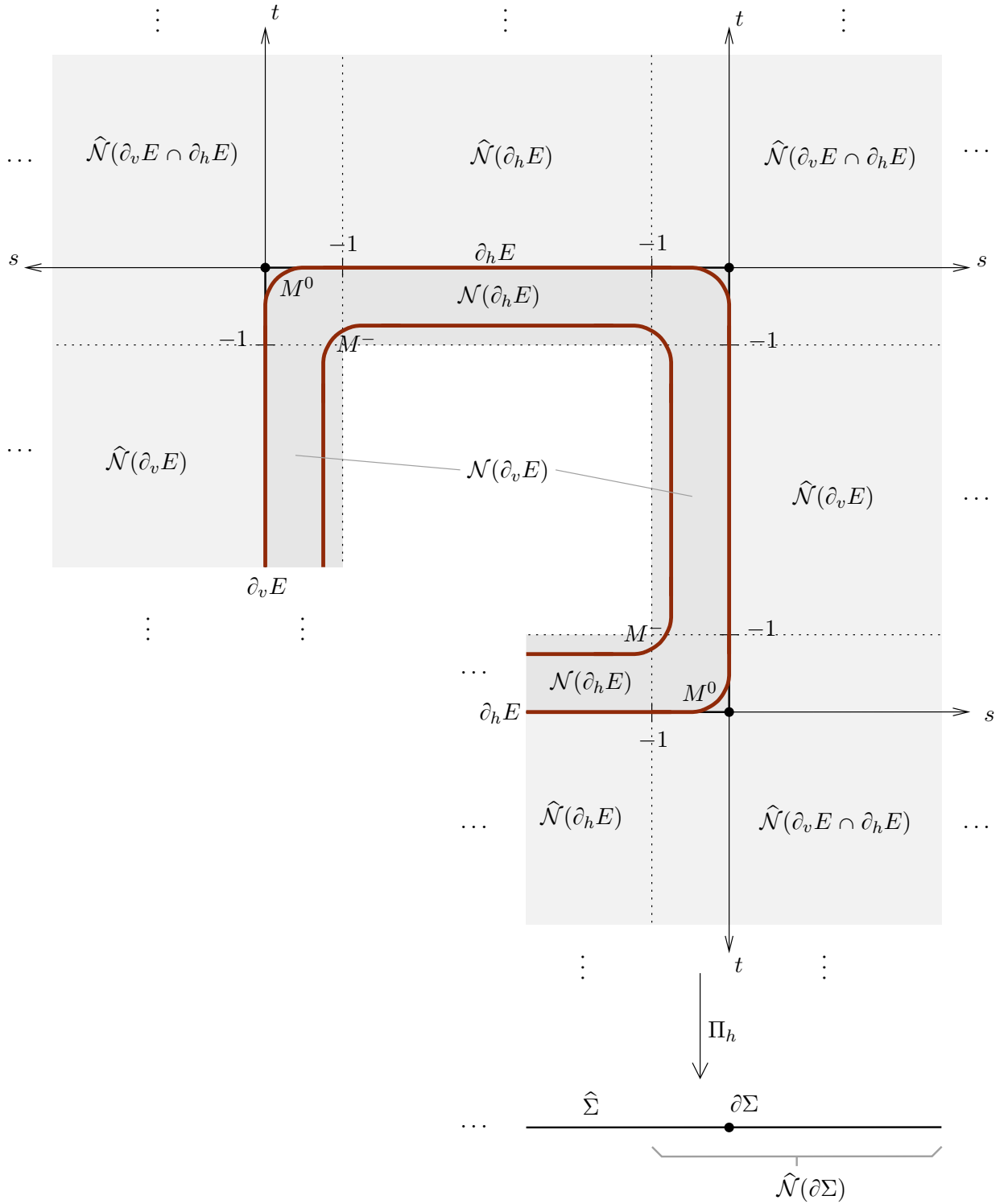

FIGURE 2. The darkly shaded region is the model collar neighborhood  $E$  (with boundary  $\partial E = \partial_v E \cup \partial_h E$  and corner  $\partial_v E \cap \partial_h E$ ), together with the smooth hypersurfaces  $M^0, M^- \subset E$  defined in §3.1. The lightly shaded region represents the rest of the double completion  $\hat{E} \supset E$  as defined in §3.2.

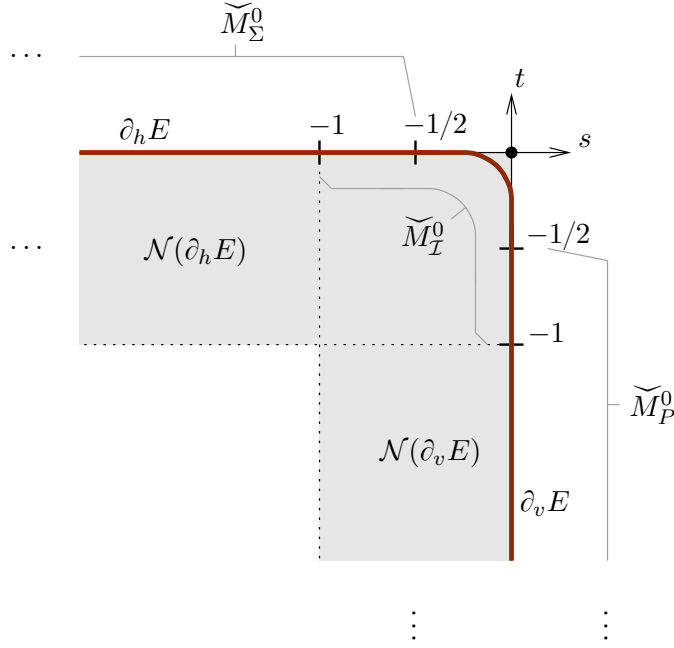

FIGURE 3. The decomposition  $M^0 = \tilde{M}_P^0 \cup \tilde{M}_I^0 \cup \tilde{M}_\Sigma^0$ .

where  $\hat{\Phi}$  is the obvious extension of the previous gluing map to a diffeomorphism

$$\begin{aligned} (-1, \infty) \times \overbrace{(-1, \infty) \times \partial M_\Sigma}^{\hat{\mathcal{N}}(\partial M_\Sigma)} &\xrightarrow{\hat{\Phi}} (-1, \infty) \times \overbrace{(-1, \infty) \times \partial M_P}^{\hat{\mathcal{N}}(\partial M_P)}, \\ (t, s, x) &\mapsto (s, t, x). \end{aligned}$$

This noncompact 4-manifold without boundary contains  $E$  as a bounded subdomain, and the collars  $\mathcal{N}(\partial_v E)$  and  $\mathcal{N}(\partial_h E)$  are then bounded subsets of the enlarged subsets

$$\hat{\mathcal{N}}(\partial_v E) := (-1, \infty) \times \hat{M}_P, \quad \hat{\mathcal{N}}(\partial_h E) := (-1, \infty) \times \hat{M}_\Sigma,$$

with the  $s$ - and  $t$ -coordinates now taking values in  $(-1, \infty)$ . Their intersection is the so-called **diagonal end**

$$\hat{\mathcal{N}}(\partial_v E \cap \partial_h E) := \hat{\mathcal{N}}(\partial_v E) \cap \hat{\mathcal{N}}(\partial_h E),$$

whose connected components carry coordinates  $(s, \phi, t, \theta)$  identifying them with  $(-1, \infty) \times S^1 \times (-1, \infty) \times S^1$ . The fibrations  $\Pi_h$  and  $\Pi_v$  have natural extensions

$$\begin{aligned} \hat{\mathcal{N}}(\partial_h E) &= (-1, \infty) \times (\hat{\Sigma} \times S^1) \xrightarrow{\Pi_h} \hat{\Sigma} : (t, (z, \theta)) \mapsto \pi_\Sigma(z, \theta) = z, \\ \hat{\mathcal{N}}(\partial_v E) &= (-1, \infty) \times \hat{M}_P \xrightarrow{\Pi_v} (-1, \infty) \times S^1 : (s, x) \mapsto (s, \pi_P(x)), \end{aligned}$$

hence  $\Pi_h(s, \phi, t, \theta) = (s, \phi)$  and  $\Pi_v(s, \phi, t, \theta) = (s, m\phi)$  on the diagonal end. We denote the resulting vertical subbundle by  $V\hat{E} \subset T\hat{E}$ . Figure 2 shows the complement of  $E$  in  $\hat{E}$  as the lightly shaded region.



**3.3. Symplectic structure.** The data on  $\widehat{E}$  defined in this section constitute an enhancement and extension of the Liouville structure already defined on  $E \subset \widehat{E}$  in [LVW, §4.1].

Fix a complex structure  $j$  on  $\Sigma$  that takes the form

$$j\partial_s = \frac{1}{m}\partial_\phi \quad \text{on } \widehat{\mathcal{N}}(\partial\Sigma),$$

where for each component of  $\widehat{\mathcal{N}}(\partial\Sigma)$ ,  $m \in \mathbb{N}$  is the multiplicity that appeared in (3.1); recall that this number may differ on distinct connected components of  $\widehat{\mathcal{N}}(\partial\Sigma)$ . Next, fix a  $j$ -convex function  $\varphi : \widehat{\Sigma} \rightarrow \mathbb{R}$  with

$$\varphi(s, \phi) = e^s \quad \text{on } \widehat{\mathcal{N}}(\partial\Sigma).$$

Such a function can always be found by starting from a Morse function on  $\Sigma$  with critical points of index 0 and 1 and then postcomposing it with a sufficiently convex function, see e.g. [LW11, Lemma 4.1]. This gives rise to a Liouville form

$$\sigma := -d\varphi \circ j$$

on  $\widehat{\Sigma}$  with

$$\sigma = me^s d\phi \quad \text{on } \widehat{\mathcal{N}}(\partial\Sigma).$$

We will also use  $\sigma$  to denote the pullback of this Liouville form under the trivial bundle projection  $\Pi_h : \widehat{\mathcal{N}}(\partial_h E) \rightarrow \widehat{\Sigma}$ , and since  $\pi_P(\phi, t, \theta) = m\phi$  on  $\widehat{\mathcal{N}}(\partial M_P)$ ,  $\sigma$  extends globally to a 1-form on  $\widehat{E}$  satisfying

$$\sigma = e^s d\pi_P \quad \text{on } \widehat{\mathcal{N}}(\partial_v E),$$

where we are abusing notation slightly by using  $\pi_P : \widehat{\mathcal{N}}(\partial_v E) \rightarrow S^1$  to denote the composition of the fibration  $\pi_P : \widehat{M}_P \rightarrow S^1$  with the obvious projection  $\widehat{\mathcal{N}}(\partial_v E) = (-1, 0] \times \widehat{M}_P \rightarrow \widehat{M}_P$ , hence defining  $d\pi_P$  as a real-valued 1-form on  $\widehat{\mathcal{N}}(\partial_v E)$ .

Next, choose a 1-form  $\lambda$  on  $\widehat{M}_P$  such that  $d\lambda$  is positive on all fibers of  $\pi_P : \widehat{M}_P \rightarrow S^1$  and

$$\lambda = e^t d\theta \quad \text{on } \widehat{\mathcal{N}}(\partial M_P).$$

Such a 1-form can easily be found by first defining it on a single fiber and then acting on it with the monodromy and interpolating (see e.g. [Etn06, Theorem 3.13]). We will use the same symbol to denote the pullback of  $\lambda$  via the projection  $\widehat{\mathcal{N}}(\partial_v E) = (-1, \infty) \times \widehat{M}_P \rightarrow \widehat{M}_P$ , and it then extends to a global 1-form on  $\widehat{E}$  such that

$$\lambda = e^t d\theta \quad \text{on } \widehat{\mathcal{N}}(\partial_h E).$$

Since  $d\lambda|_{V\widehat{W}} > 0$  by construction, one can regard  $\lambda$  as a *fiberwise Liouville form* (cf. [LVW, §2]) on  $\widehat{E}$ , and we observe also that since  $\lambda|_{T(\partial_h E)} = d\theta$ , its restriction to  $\partial E = \partial_v E \cup \partial_h E$  can also be regarded as a *fiberwise Giroux form*.

For applications in the almost Stein category, it will be convenient to add another condition on the construction of  $\lambda$ . Pick a smooth family  $J_{\text{fib}}$  of complex structures on the fibers of  $\pi_P : \widehat{M}_P \rightarrow S^1$  such that

$$J_{\text{fib}}\partial_t = \partial_\theta \quad \text{on } \widehat{\mathcal{N}}(\partial M_P).$$

On each individual fiber, the space of smooth  $J_{\text{fib}}$ -convex functions that match  $e^t$  in the collar near the boundary is convex. One can therefore use a partition of unity to construct a smooth function  $f_{\text{fib}} : \widehat{M}_P \rightarrow \mathbb{R}$  whose restriction to each fiber has this property, and we are free to assume

$$(3.4) \quad \lambda|_{V\widehat{E}} = -df_{\text{fib}} \circ J_{\text{fib}}|_{V\widehat{E}}.$$

We can now apply the Thurston trick as described in [LVW, §2.1]: for any constant  $K \geq 0$ , we define a 1-form  $\lambda_K$  by

$$\lambda_K := K\sigma + \lambda.$$

Then there exists a constant  $K_0 \geq 0$  such that  $d\lambda_K$  is symplectic everywhere on  $\widehat{E}$  for each  $K \geq K_0$ . Note that the unboundedness of  $\widehat{E}$  does not pose any problem here due to the precise formulas we have for  $\lambda$  near infinity (cf. [LVW, Remark 4.1]). In particular, we have

$$(3.5) \quad \lambda_K = K\sigma + e^t d\theta \text{ on } \widehat{\mathcal{N}}(\partial_h E), \quad \text{and} \quad \lambda_K = Ke^s d\pi_P + \lambda \text{ on } \widehat{\mathcal{N}}(\partial_v E),$$

hence

$$(3.6) \quad \lambda_K = Kme^s d\phi + e^t d\theta \quad \text{on } \widehat{\mathcal{N}}(\partial_v E \cup \partial_h E).$$

We will assume that the condition  $K \geq K_0$  holds from now on, and we will occasionally also enlarge  $K_0$  in order to satisfy extra conditions (e.g. for Lemma 3.3 below). Since  $d\lambda_K$  is now symplectic, there exists a Liouville vector field  $V_K$  on  $(\widehat{E}, d\lambda_K)$  defined via the condition

$$d\lambda_K(V_K, \cdot) \equiv \lambda_K.$$

From (3.5) we find

$$(3.7) \quad V_K = V_\sigma + \partial_t \quad \text{on } \widehat{\mathcal{N}}(\partial_h E) = (-1, \infty) \times \widehat{\Sigma} \times S^1,$$

where  $V_\sigma$  denotes the Liouville vector field on  $\widehat{\Sigma}$  dual to  $\sigma$ ; in particular,  $V_\sigma = \partial_s$  on the cylindrical end  $\widehat{\mathcal{N}}(\partial\Sigma)$ , hence

$$V_K = \partial_s + \partial_t \quad \text{on } \widehat{\mathcal{N}}(\partial_v E \cap \partial_h E).$$

**Lemma 3.3.** *If  $K_0 \geq 0$  is sufficiently large and  $K \geq K_0$ , then  $ds(V_K) > 0$  holds on  $\widehat{\mathcal{N}}(\partial_v E)$ .*

*Proof.* It suffices to show that the restriction of  $\lambda_K$  to  $\{s\} \times \widehat{M}_P$  for each  $s \in (-1, \infty)$  is a positive contact form, or equivalently,

$$ds \wedge \lambda_K \wedge d\lambda_K > 0 \quad \text{on } \widehat{\mathcal{N}}(\partial_v E).$$

Since  $\sigma = e^s d\pi_P$  on  $\widehat{\mathcal{N}}(\partial_v E)$ , we compute

$$\begin{aligned} ds \wedge \lambda_K \wedge d\lambda_K &= ds \wedge (Ke^s d\pi_P + \lambda) \wedge (Ke^s ds \wedge d\pi_P + d\lambda) \\ &= Ke^s \left( ds \wedge d\pi_P \wedge d\lambda + \frac{1}{Ke^s} ds \wedge \lambda \wedge d\lambda \right), \end{aligned}$$

and see that the first term is a positive volume form since  $d\lambda|_{V\widehat{E}} > 0$ , while the second is bounded with respect to any  $s$ -invariant metric and thus uniformly small if  $K$  is large.  $\square$

The lemma implies that for any pair of constants  $s_0, t_0 \in (-1, \infty)$ , the boundary of the region  $\{s \leq s_0, t \leq t_0\} \subset \widehat{E}$  is a contact hypersurface in  $(\widehat{E}, d\lambda_K)$  after smoothing the corner.

For applications to weak fillings, we will also need to allow certain cohomological perturbations to the model  $(\widehat{E}, d\lambda_K)$ . Fix on  $M$  a closed 2-form  $\eta$  that has support in the interior of  $M_P \setminus \mathcal{N}(\partial M_P)$ , so pulling back via the projection  $\widehat{\mathcal{N}}(\partial_v E) = (-1, \infty) \times \widehat{M}_P \rightarrow \widehat{M}_P$  defines  $\eta$  as a closed 2-form on  $\widehat{E}$  that vanishes in  $\widehat{\mathcal{N}}(\partial_h E)$  and is uniformly bounded on  $\widehat{\mathcal{N}}(\partial_v E)$  for any choice of  $s$ -invariant metric. In the following, we say that an oriented hypersurface endowed with a co-oriented contact structure in a symplectic 4-manifold is **weakly contact** if the restriction of the symplectic form to the contact structure is positive.

**Lemma 3.4.** *Given  $K \geq K_0$ , there exists a constant  $C_0 > 0$  such that for all  $C \geq C_0$ , the 2-form  $\omega'_E := C d\lambda_K + \eta$  is symplectic on  $\widehat{E}$  and for each  $s \in (-1, \infty)$ , the hypersurface*

$$\partial_v^s \widehat{E} := \{s\} \times \widehat{M}_P \subset \widehat{E}$$

*with contact structure  $\xi_v^s := \ker(\lambda_K|_{T(\partial_v^s \widehat{E})})$  is weakly contact in  $(\widehat{E}, \omega'_E)$ .*

*Proof.* This is mainly a matter of replacing  $d\lambda$  with  $d\lambda + \frac{1}{C}\eta$  and then repeating the usual calculations carefully enough to make sure that nothing goes wrong as  $s \rightarrow \infty$ . The nondegeneracy of  $\omega'_E$  on  $\widehat{N}(\partial_v E)$ , for instance, follows by computing

$$\begin{aligned} \frac{1}{C^2} \omega'_E \wedge \omega'_E &= \left( d\lambda_K + \frac{1}{C}\eta \right) \wedge \left( d\lambda_K + \frac{1}{C}\eta \right) \\ &= Ke^s \left[ 2 ds \wedge d\pi_P \wedge \left( d\lambda + \frac{1}{C}\eta \right) + \frac{1}{Ke^s} \left( d\lambda + \frac{1}{C}\eta \right) \wedge \left( d\lambda + \frac{1}{C}\eta \right) \right], \end{aligned}$$

in which the first term in the brackets is uniformly positive for sufficiently large  $C > 0$  and the second is bounded with respect to any  $s$ -invariant metric. The weak contact condition for  $(\partial_v^s \widehat{E}, \xi_v^s)$  follows by a similar modification of the proof of Lemma 3.3, showing

$$\frac{1}{C} ds \wedge \lambda_K \wedge \omega'_E = ds \wedge \lambda_K \wedge \left( d\lambda_K + \frac{1}{C}\eta \right) > 0 \quad \text{on } \widehat{N}(\partial_v E).$$

□

For the remainder of §3, we fix  $K \geq K_0$ ,  $C \geq C_0$  as in the above lemma and consider the rescaled symplectic form

$$\omega_E := \frac{1}{KC} (C d\lambda_K + \eta) = d\sigma + \frac{1}{K} d\lambda + \frac{1}{KC} \eta$$

on  $\widehat{E}$ . The scaling by  $1/KC$  has no deep significance but will be convenient for technical reasons when we talk about stable Hamiltonian structures below. Since  $\eta$  vanishes in  $\widehat{N}(\partial_h E)$ ,  $V_K$  is also a Liouville vector field for  $\omega_E$  in this region. Then the fact that  $V_K = \partial_s + \partial_t$  in the diagonal end implies that the boundary of any region of the form  $\{s \leq s_0, t \leq t_0\} \subset \widehat{E}$  can be made into a *weakly* contact hypersurface in  $(\widehat{E}, \omega_E)$  by smoothing the corner, with the contact structure defined by restricting  $\lambda_K$ . Two specific examples of smooth hypersurfaces were defined in this way at the end of §3.1: we define contact forms and contact structures on  $M^0$  and  $M^-$  respectively by

$$\begin{aligned} \alpha^0 &:= \lambda_K|_{TM^0}, & \xi_0 &:= \ker \alpha^0 \subset TM^0, \\ \alpha^- &:= \lambda_K|_{TM^-}, & \xi_- &:= \ker \alpha^- \subset TM^-. \end{aligned}$$

This makes  $(M^-, \xi_-)$  and  $(M^0, \xi_0)$  into weakly contact hypersurfaces in  $(\widehat{E}, \omega_E)$ , and the definition of  $\lambda_K$  implies that both are (after suitably identifying  $M^0$  and  $M^-$  with  $M$ ) supported by the spinal open book  $\pi$ , hence both are isotopic to  $\xi$ .

**3.4. Stable Hamiltonian structure.** We now endow the hypersurface  $M^0 \subset \widehat{E}$  with a stable Hamiltonian structure that is related to its contact structure  $\xi_0$  but will be better suited for finding holomorphic pages in its symplectization. Fix a smooth cutoff function  $\beta : (-1, \infty) \rightarrow [0, 1]$  satisfying

- $\beta \equiv 0$  on  $(-1, -1/2]$ ;

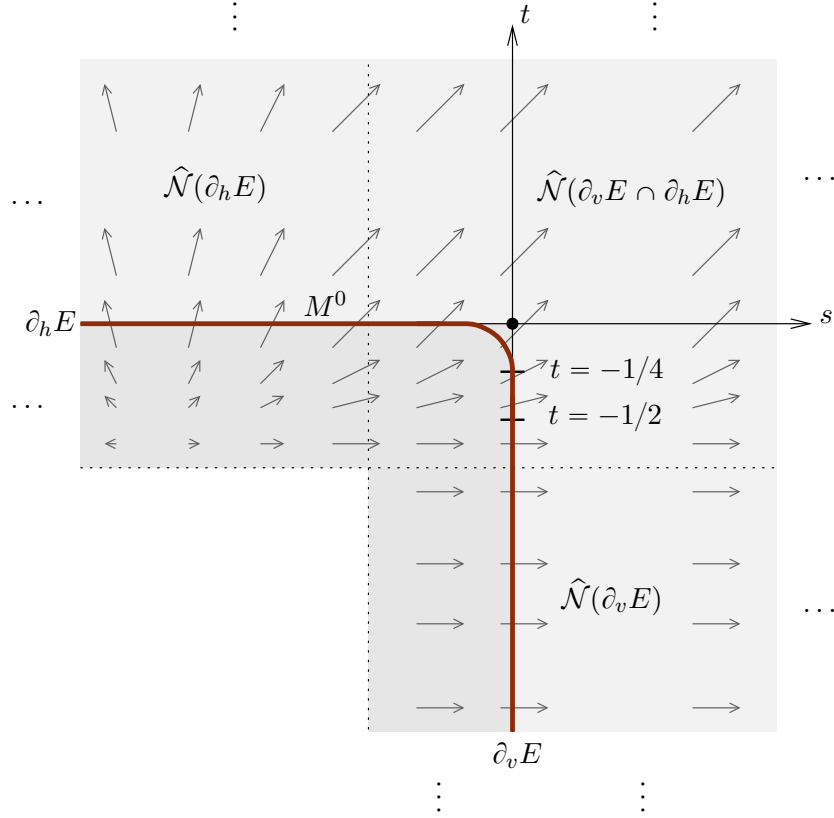

FIGURE 4. The stabilizing vector field  $Z$  transverse to  $M^0 \subset \widehat{E}$ .

- $\beta \equiv 1$  on  $[-1/4, \infty)$ ;
- $\beta' \geq 0$  and  $\text{supp}(\beta') \subset (-1/2, -1/4)$ .

Now consider the vector field on  $\widehat{E}$  defined by (see Figure 4)

$$Z := \begin{cases} V_\sigma + \beta(t)\partial_t & \text{on } \widehat{N}(\partial_h E), \\ \partial_s & \text{everywhere else.} \end{cases}$$

Here again  $V_\sigma$  denotes the Liouville vector field dual to  $\sigma$  on  $\widehat{\Sigma}$ , so we observe that  $Z \equiv V_K$  on the region  $\{t \geq -1/4\} \subset \widehat{N}(\partial_h E)$ . Everywhere else in  $\widehat{N}(\partial_v E \cap \partial_h E)$ , we can plug in  $V_\sigma = \partial_s$  and thus write  $Z = \partial_s + \beta(t)\partial_t$ . This vector field is obviously transverse to  $M^0$ ; we will now show that it is also a *stabilizing* vector field in the sense of §2.1, and thus makes  $M^0$  into a stable hypersurface.

**Lemma 3.5.** *The vector field  $Z$  is a stabilizing vector field for  $M^0$  in  $(\widehat{E}, \omega_E)$ .*

*Proof.* This is immediate in the region where  $Z = V_K$ , since  $V_K$  is Liouville for  $\omega_E$  in that region and all Liouville vector fields have the stabilizing property. It is similarly immediate in the region where  $Z = \partial_s$ , as the hypersurfaces obtained by flowing  $\partial_v E$  along  $\partial_s$  each have constant  $s$ -coordinate and  $\omega_E$  thus restricts to each of them as  $\frac{1}{K}d\lambda + \frac{1}{KC}\eta$ , defining a characteristic line field that does not depend on  $s$ . It remains to consider the region  $-1/2 \leq t \leq -1/4$  in which  $Z = \partial_s + \beta(t)\partial_t$ , and the key point here is that the characteristic

line field is exceedingly simple: we have  $\omega_E = \frac{1}{K} d\lambda_K = me^s ds \wedge d\phi + \frac{1}{K} e^t dt \wedge d\theta$  in this region, while the hypersurfaces in question still have constant  $s$ -coordinate, hence the characteristic line field on each is spanned by  $\partial_\phi$ , a vector field that is preserved by the flow of  $Z$ .  $\square$

The lemma implies that the pair  $\mathcal{H}_0 = (\Omega_0, \Lambda_0)$  defined by

$$\Omega_0 := \omega_E|_{TM^0}, \quad \Lambda_0 := \iota_Z \omega_E|_{TM^0}$$

is a stable Hamiltonian structure on  $M^0$ , cf. §2.1. We will denote the corresponding oriented hyperplane field by  $\Xi_0 := \ker \Lambda_0 \subset TM^0$  and the Reeb vector field by  $R_0$ , where by definition

$$\Omega_0(R_0, \cdot) \equiv 0, \quad \Lambda_0(R_0) \equiv 1.$$

One can compute the following explicit formulas for  $\Lambda_0$ ,  $\Omega_0$  and  $R_0$  in the regions  $\widetilde{M}_\Sigma^0, \widetilde{M}_T^0, \widetilde{M}_P^0 \subset M^0$  defined in §3.1 (cf. Figure 3).

On  $\widetilde{M}_\Sigma^0 \subset \partial_h E = \Sigma \times S^1$ ,  $Z$  matches the Liouville vector field  $V_K$ , which is  $\omega_E$ -dual to  $\frac{1}{K} \lambda_K$ , hence

$$(\Omega_0, \Lambda_0) = \left( \frac{1}{K} d\alpha^0, \frac{1}{K} \alpha^0 \right) = \left( d\sigma, \frac{1}{K} d\theta + \sigma \right) \quad \text{on } \widetilde{M}_\Sigma^0.$$

It follows that  $R_0$  is a suitably rescaled version of the Reeb vector field for  $\alpha^0$ , that is,

$$R_0 = K \partial_\theta \quad \text{on } \widetilde{M}_\Sigma^0.$$

On  $\widetilde{M}_P^0 \subset \partial_v E = M_P$ ,  $Z = \partial_s$  and thus

$$(\Omega_0, \Lambda_0) = \left( \frac{1}{K} d\lambda + \frac{1}{KC} \eta, d\pi_P \right) \quad \text{on } \widetilde{M}_P^0,$$

so  $d\Lambda_0 = 0$  on this region and thus  $\Xi_0$  is integrable; indeed, the integral submanifolds of  $\Xi_0$  are simply the fibers of  $\pi_P : M_P \rightarrow S^1$ . The Reeb vector field can be written as

$$(3.8) \quad R_0 = e_{S^1}^\# \quad \text{on } \widetilde{M}_P^0,$$

where we denote by  $e_{S^1} \in TS^1$  the canonical unit vector field on  $S^1 = \mathbb{R}/\mathbb{Z}$  and use the superscript “#” to denote its horizontal lift with respect to the connection on  $\pi_P : M_P \rightarrow S^1$  defined as the  $(C d\lambda + \eta)$ -symplectic complement of the vertical subbundle. In each collar  $S^1 \times (-1, -1/2) \times S^1 \subset \mathcal{N}(\partial M_P) \cap \widetilde{M}_P^0$ , we can write  $d\pi_P = m d\phi$  for the appropriate multiplicity  $m \in \mathbb{N}$  and use  $(\phi, t, \theta)$ -coordinates to write

$$(3.9) \quad R_0 = \frac{1}{m} \partial_\phi \quad \text{on } \widetilde{M}_P^0 \cap \mathcal{N}(\partial M_P).$$

Finally, using the coordinates  $(\rho, \phi, \theta) \in (-1, 1) \times S^1 \times S^1$  on connected components of  $\widetilde{M}_T^0$ ,  $\Omega_0$  and  $\Lambda_0$  are determined by the functions  $F$  and  $G$  that were chosen in §3.1 for smoothing the corner, as well as the cutoff function  $\beta$  in the definition of  $Z$ : we have

$$(3.10) \quad \begin{aligned} \Omega_0 &= me^{F(\rho)} F'(\rho) d\rho \wedge d\phi + \frac{1}{K} e^{G(\rho)} G'(\rho) d\rho \wedge d\theta, \\ \Lambda_0 &= me^{F(\rho)} d\phi + \frac{1}{K} e^{G(\rho)} \beta(G(\rho)) d\theta, \end{aligned}$$

which leads to

$$(3.11) \quad R_0 = \frac{1}{\beta(G(\rho))F'(\rho) - G'(\rho)} \left( -\frac{1}{m} e^{-F(\rho)} G'(\rho) \partial_\phi + K e^{-G(\rho)} F'(\rho) \partial_\theta \right).$$

**3.5. Nondegenerate perturbation.** The stable Hamiltonian structure  $\mathcal{H}_0 = (\Omega_0, \Lambda_0)$  defined above on  $M^0$  has the unfortunate property that the orbits of  $R_0$  in  $\widetilde{M}_\Sigma^0$  are degenerate. We will follow the standard procedure for perturbing to get nondegenerate orbits, which depends on a choice of Morse function on the space parametrizing the orbits, in this case  $\Sigma$ . Choose a smooth function

$$H : \Sigma \rightarrow [0, \infty)$$

such that

- (1)  $H$  is Morse outside of  $\mathcal{N}(\partial\Sigma)$ ;
- (2) On  $\mathcal{N}(\partial\Sigma)$  in coordinates  $(s, \phi)$ ,  $H$  depends only on  $s$ , and it satisfies  $\partial_s H < 0$  except on a smaller neighborhood of the boundary with closure in the region  $\{-1/4 < s \leq 0\}$ , where  $H$  vanishes.

We shall denote by

$$\text{Crit}_M(H) \subset \Sigma$$

the finite set of Morse critical points of  $H$ ; this excludes the critical points near  $\partial\Sigma$  where  $H$  vanishes. Extend  $H$  to a smooth function

$$\widehat{H} : M^0 \rightarrow [0, \infty)$$

that vanishes on  $\widetilde{M}_P^0$  and satisfies  $\widehat{H}(z, \theta) = H(z)$  on  $\widetilde{M}_\Sigma^0 \subset \Sigma \times S^1$ , and  $\widehat{H}(\rho, \phi, \theta) = H(F(\rho), \phi)$  on  $\widetilde{M}_T^0$ . Now if  $\Phi_Z^\tau$  denotes the flow of  $Z$  for time  $\tau$ , we fix a small constant  $\varepsilon > 0$  and observe that the perturbed hypersurface (see Figure 5)

$$M^+ := \left\{ \Phi_Z^{\varepsilon \widehat{H}(x)}(x) \in \widehat{E} \mid x \in M^0 \right\}$$

is still stabilized by  $Z$ ; indeed,  $M^+$  still matches  $\partial_v E$  in the region where  $Z$  is not  $V_K$ , and everywhere else  $Z$  is Liouville and manifestly transverse to  $M^+$ . The obvious diffeomorphism of  $M^0$  to  $M^+$  defined by flowing along  $Z$  induces a decomposition

$$M^+ = \widetilde{M}_\Sigma^+ \cup \widetilde{M}_T^+ \cup \widetilde{M}_P^+$$

corresponding to the decomposition  $M^0 = \widetilde{M}_\Sigma^0 \cup \widetilde{M}_T^0 \cup \widetilde{M}_P^0$  that we defined in §3.1, and we will use the same coordinate systems on these subsets that were used on  $\widetilde{M}_\Sigma^0$ ,  $\widetilde{M}_T^0$  and  $\widetilde{M}_P^0$ . Let

$$\mathcal{H}_+ := (\Omega_+, \Lambda_+)$$

denote the stable Hamiltonian structure induced by  $Z$  on  $M^+$ , with oriented hyperplane field  $\Xi_+$  and Reeb vector field  $R_+$ . Since  $\widetilde{M}_\Sigma^0$  is a contact hypersurface and  $\widetilde{M}_\Sigma^+$  is obtained from it by flowing along a Liouville vector field,  $(\Omega_+, \Lambda_+)$  on  $\widetilde{M}_\Sigma^+$  takes the form  $((1/K)d\alpha^+, (1/K)\alpha^+)$ , where  $\alpha^+$  is a contact form given by

$$(3.12) \quad \alpha^+ := \lambda_K|_{T\widetilde{M}_\Sigma^+} = e^{\varepsilon \widehat{H}} \alpha^0 = e^{\varepsilon \widehat{H}}(K\sigma + d\theta).$$

The resulting perturbed Reeb vector field takes the form

$$(3.13) \quad R_+ = e^{-\varepsilon \widehat{H}} ((1 + \varepsilon\sigma(X_H)) K \partial_\theta - \varepsilon X_H) \quad \text{on } \widetilde{M}_\Sigma^+,$$

where  $X_H$  denotes the Hamiltonian vector field of  $H$  on  $(\Sigma, d\sigma)$ , determined by

$$d\sigma(X_H, \cdot) = -dH.$$

Notice that for some large threshold  $T > 0$  that goes to  $\infty$  as  $\varepsilon \rightarrow 0$ , all periodic orbits up to period  $T$  in  $\widetilde{M}_\Sigma^+$  have image  $\{z\} \times S^1 \subset \Sigma \times S^1$  for some  $z \in \text{Crit}_M(H)$ . We will generally fix the

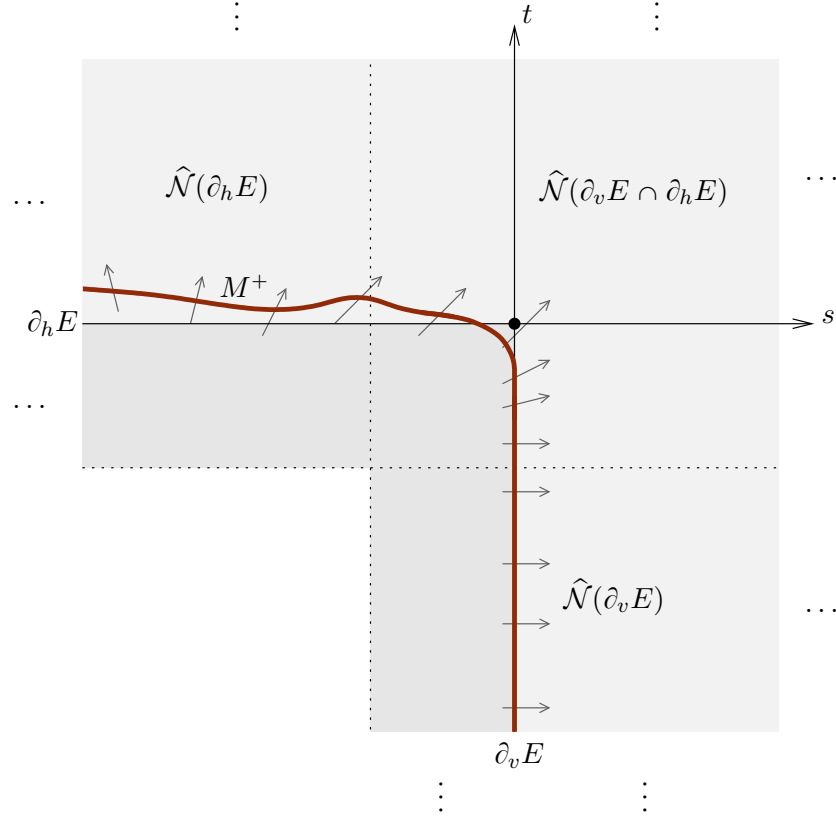
 FIGURE 5. The perturbed stable hypersurface  $M^+ \subset \widehat{E}$ .

value of  $K$  and assume  $\varepsilon > 0$  is sufficiently small to arrange this whenever convenient; we can then also assume without loss of generality that  $\partial_\theta$  and  $\Xi_+$  are transverse, so the projection  $T\pi_\Sigma : T\widetilde{M}_\Sigma^+ \rightarrow T\Sigma$  restricts to  $\Xi_+$  as a fiberwise orientation-preserving isomorphism

$$(3.14) \quad \Xi_+|_{\widetilde{M}_\Sigma^+} \xrightarrow{T\pi_\Sigma} T\Sigma.$$

On  $\widetilde{M}_\Sigma^+$ , the formulas (3.10) and (3.11) can be adapted to write  $\Omega_+$ ,  $\Lambda_+$  and  $R_+$  as

$$(3.15) \quad \begin{aligned} \Omega_+ &= m e^{F_+(\rho)} F'_+(\rho) d\rho \wedge d\phi + \frac{1}{K} e^{G_+(\rho)} G'_+(\rho) d\rho \wedge d\theta, \\ \Lambda_+ &= m e^{F_+(\rho)} d\phi + \frac{1}{K} e^{G_+(\rho)} \beta(G_+(\rho)) d\theta, \\ R_+ &= \frac{1}{\beta(G_+(\rho)) F'_+(\rho) - G'_+(\rho)} \left( -\frac{1}{m} e^{-F_+(\rho)} G'_+(\rho) \partial_\phi + K e^{-G_+(\rho)} F'_+(\rho) \partial_\theta \right), \end{aligned}$$

where the perturbed versions of the functions  $F$  and  $G$  are defined by

$$F_+(\rho) := F(\rho) + \varepsilon H(F(\rho), \cdot), \quad G_+(\rho) := G(\rho) + \varepsilon H(G(\rho), \cdot).$$

Let us file away for future use the following detail, which results from the particular conditions we have imposed on  $G$  and  $H$ .

**Lemma 3.6.** *The function  $G_+$  satisfies  $G'_+(\rho) < 0$  for all  $\rho \in (-1, 1)$ , hence by (3.15),  $d\phi(R_+) \neq 0$  on  $\widetilde{M}_T^+$ .  $\square$*

The region  $\widetilde{M}_P^+$  is identical to  $\widetilde{M}_P^0$ , and here  $(\Omega_+, \Lambda_+) = (\Omega_0, \Lambda_0)$ , with  $R_+$  also given by (3.8) and (3.9).

**3.6. The cylindrical end.** As was discussed in §2.1, one can use the Moser deformation trick to show that  $M^+$  has a collar neighborhood in  $(\widehat{E}, \omega_E)$  that can be identified symplectically with

$$(3.16) \quad ((-\delta, \delta) \times M^+, d((e^r - 1)\Lambda_+) + \Omega_+),$$

for sufficiently small  $\delta > 0$ , with  $r$  denoting the coordinate on  $(-\delta, \delta)$ . This is true for arbitrary stable Hamiltonian structures, but it will be convenient to take advantage of a few properties of our example  $\mathcal{H}_+ = (\Omega_+, \Lambda_+)$  that are nicer than the general case. To start with,  $\Xi_+ = \ker \Lambda_+$  is everywhere either a positive contact structure or a foliation, hence it is a *confoliation*; equivalently,  $\Lambda_+ \wedge d\Lambda_+ \geq 0$ . As a consequence, the collar (3.16) remains symplectic if we replace  $(-\delta, \delta) \times M^+$  by an infinite half-cylinder:

$$(3.17) \quad ([0, \infty) \times M^+, d((e^r - 1)\Lambda_+) + \Omega_+).$$

Observe that this reduces in regions where  $\Omega_+ = d\Lambda_+$  to the usual half-symplectization of a contact form,  $([0, \infty) \times M^+, d(e^r \Lambda_+))$ . As it turns out, a half-cylinder of the form (3.17) is already present in the model  $(\widehat{E}, \omega_E)$ . Denote

$$\widehat{\mathcal{N}}_+(\partial E) := \left\{ \Phi_Z^\tau(x) \in \widehat{E} \mid \tau \geq 0, x \in M^+ \right\} \subset \widehat{E},$$

with  $\Phi_Z^\tau$  again denoting the flow of  $Z$  for time  $\tau$ . This is the *unbounded* closed subset of  $\widehat{E}$  with boundary  $M^+$ ; see Figure 6.

**Lemma 3.7.** *The region  $\widehat{\mathcal{N}}_+(\partial E)$  is the image of an embedding  $\Psi : [0, \infty) \times M^+ \hookrightarrow \widehat{E}$  defined on  $[0, \infty) \times (1/4, 1/2) \times S^1 \times S^1 \subset [0, \infty) \times \widetilde{M}_T^+$  by*

$$(3.18) \quad \begin{aligned} \Psi(r, \rho, \phi, \theta) &= (r, \phi, -\rho + \log[(e^r - 1)\beta(-\rho) + 1], \theta) \\ &\in (-1, \infty) \times S^1 \times (-1, \infty) \times S^1 \subset \widehat{\mathcal{N}}(\partial_v E \cap \partial_h E), \end{aligned}$$

and everywhere else by

$$\Psi(r, x) = \Phi_Z^r(x),$$

Moreover,  $\Psi^*\omega_E = d((e^r - 1)\Lambda_+) + \Omega_+$ .

*Proof.* It is straightforward to see that  $\Psi$  is a smooth map whose image is  $\widehat{\mathcal{N}}_+(\partial E)$ ; indeed, since  $Z = \partial_s + \beta(t)\partial_t$  on the diagonal end, the definition in (3.18) matches the flow of  $Z$  for time  $r$  on regions where  $\beta(-\rho)$  is 0 or 1, which excludes only a compact subset of  $\{\rho \in (1/4, 1/2)\}$ . The main thing to verify is thus the formula for  $\Psi^*\omega_E$ . Consider first  $(r, \rho, \phi, \theta) \in [0, \infty) \times \widetilde{M}_T^+$  with  $\rho \in [1/4, 1/2]$ . Then  $F_+(\rho) = 0$  and  $G_+(\rho) = -\rho$ , so we have  $\Lambda_+ = Km d\phi + \frac{1}{K}e^{-\rho}\beta(-\rho) d\theta$  and  $\Omega_+ = -\frac{1}{K}e^{-\rho} d\rho \wedge d\theta$ . Meanwhile, since the image of  $\Psi$  on this region lies in  $\widehat{\mathcal{N}}(\partial_v E \cap \partial_h E)$ , we have  $\omega_E = \frac{1}{K} d\lambda_K$  and  $\lambda_K = Kme^s d\phi + e^t d\theta$ , hence

$$\Psi^*\lambda_K = Kme^r d\phi + e^{-\rho}[(e^r - 1)\beta(-\rho) + 1] d\theta.$$

From these formulas, a quick computation shows  $\Psi^*\omega_E = \frac{1}{K} d(\Psi^*\lambda_K) = d((e^r - 1)\Lambda_+) + \Omega_+$ .



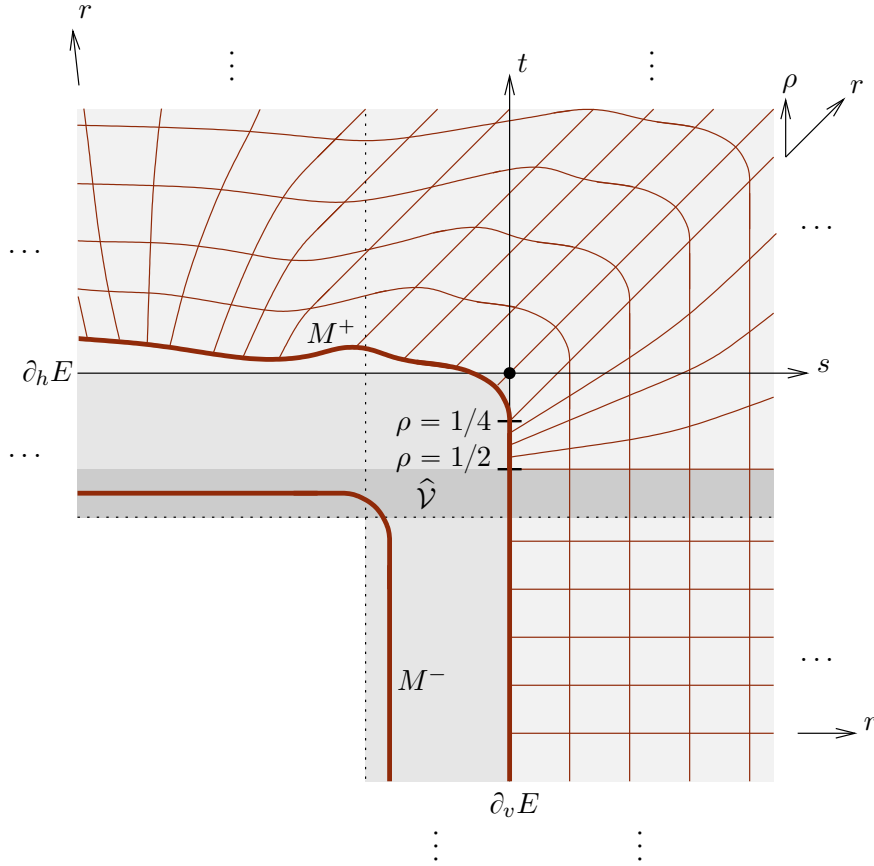

FIGURE 6. The grid represents the half-cylinder  $[0, \infty) \times M^+ \cong \widehat{\mathcal{N}}_+(\partial E) \subset \widehat{E}$ . The darkly shaded region is the set  $\widehat{V} \subset \widehat{E}$  defined in §3.7, where the holomorphic vertebrae live.

For  $x \in \widetilde{M}_P^+ \subset \partial_v E$ , we have  $Z = \partial_s$  and thus  $\Psi(r, x) = (r, x) \in \widehat{\mathcal{N}}(\partial_v E)$ , so writing  $\omega_E = \frac{1}{K} d\lambda_K + \frac{1}{KC} \eta$  with  $\lambda_K = Ke^s d\pi_P + \lambda$  gives

$$\begin{aligned} \Psi^* \omega_E &= \frac{1}{K} d(\Psi^* \lambda_K) + \frac{1}{KC} \Psi^* \eta = d \left( e^r d\pi_P + \frac{1}{K} \lambda \right) + \frac{1}{KC} \eta \\ &= d(e^r - 1) \wedge d\pi_P + \frac{1}{K} d\lambda + \frac{1}{KC} \eta. \end{aligned}$$

This also reproduces  $d((e^r - 1)\Lambda_+) + \Omega_+$  when we plug in  $\Lambda_+ = \Lambda_0 = d\pi_P$  and  $\Omega_+ = \Omega_0 = \frac{1}{K} d\lambda + \frac{1}{KC} \eta$ .

On the remaining regions,  $Z$  is the Liouville vector field  $V_K$ , and  $\Lambda_+$  and  $\Omega_+$  match the restrictions of  $\frac{1}{K} \lambda_K$  and  $\omega_E = \frac{1}{K} d\lambda_K$  respectively to  $TM^+$ , thus

$$\Psi^* \left( \frac{1}{K} \lambda_K \right) = e^r \Lambda_+,$$

implying  $\Psi^* \omega_E = d(e^r \Lambda_+) = d((e^r - 1)\Lambda_+) + d\Lambda_+$ . The desired formula follows since  $\Omega_+ = d\Lambda_+$  on this region.  $\square$

Throughout the following, we will omit the embedding  $\Psi$  from the notation and simply identify  $[0, \infty) \times M^+$  with the subdomain  $\widehat{\mathcal{N}}_+(\partial E) \subset \widehat{E}$ .

**3.7. Almost complex and almost Stein structures.** We shall now choose an almost complex structure from the space  $\mathcal{J}(\mathcal{H}_+)$  of  $\mathbb{R}$ -invariant structures compatible with  $\mathcal{H}_+$  (see §2.2). Any  $J_+ \in \mathcal{J}(\mathcal{H}_+)$  determines an  $\omega_E$ -compatible almost complex structure on  $[0, \infty) \times M^+ = \widehat{\mathcal{N}}_+(\partial E)$ , and we will choose  $J_+ \in \mathcal{J}(\mathcal{H}_+)$  to satisfy some additional conditions that will be convenient for our main applications. It suffices to specify an orientation-preserving complex structure on the subbundle

$$J_+ : \Xi_+ \rightarrow \Xi_+$$

over each of the regions  $\widetilde{M}_\Sigma^+$ ,  $\widetilde{M}_T^+$  and  $\widetilde{M}_P^+$ , as the translation-invariance condition and  $J_+(\partial_r) = R_+$  then determine  $J_+ \in \mathcal{J}(\mathcal{H}_+)$  uniquely.

Recall that in §3.3 we endowed  $\widetilde{\Sigma}$  with a complex structure  $j$  satisfying

$$(3.19) \quad j\partial_s = \frac{1}{m}\partial_\phi$$

on its cylindrical ends, where the multiplicity  $m \in \mathbb{N}$  may be different on distinct ends. Over  $\widetilde{M}_\Sigma^+ \subset \Sigma \times S^1$ , define  $J_+ : \Xi_+ \rightarrow \Xi_+$  as the pullback of  $j$  under the fiberwise isomorphism  $\Xi_+ \rightarrow T\Sigma$  defined via  $T\pi_\Sigma$  (see (3.14)). This makes  $J_+$  invariant under the  $S^1$ -action defined by translating the  $\theta$ -coordinate.

On  $\widetilde{M}_P^+$ , which is canonically identified with an open subset of  $M_P \subset M = \partial E$ , choosing  $J_+ \in \mathcal{J}(\mathcal{H}_+)$  is equivalent to choosing smoothly varying complex structures on the fibers of  $\pi_P : M_P \rightarrow S^1$ . We already made such a choice when  $\lambda$  was defined in §3.3: set

$$J_+|_{\Xi_+} := J_{\text{fib}} \quad \text{on } \widetilde{M}_P^+,$$

which has the property that

$$(3.20) \quad J_+\partial_t = \partial_\theta \quad \text{on } \mathcal{N}(\partial M_P) \cap \widetilde{M}_P^+.$$

Now using the coordinates  $(\rho, \phi, \theta) \in (-1, 1) \times S^1 \times S^1$  on each component of  $\widetilde{M}_T^+$ , the formulas (3.15) imply that  $\Xi_+$  is spanned by vector fields of the form

$$v_1 := \partial_\rho, \quad v_2 := a(\rho)\partial_\phi + b(\rho)\partial_\theta$$

for a unique choice of smooth functions  $a, b : (-1, 1) \rightarrow \mathbb{R}$  such that  $\Lambda_+(v_2) \equiv 0$  and  $\Omega_+(v_1, v_2) \equiv 1$ . In  $\widetilde{M}_T^+ \cap \widetilde{M}_\Sigma^+$ , we write  $s = F_+(\rho) = \rho + \varepsilon H(\rho, \cdot)$ ,  $t = G_+(\rho) = \varepsilon H(\rho, \cdot) \geq 0$  and  $\beta(G_+(\rho)) = 1$ , so the fiberwise isomorphism  $\Xi_+ \rightarrow T\Sigma$  takes  $v_1$  and  $v_2$  to positive multiples of  $\partial_s$  and  $\partial_\phi$  respectively, hence by (3.19), we have

$$(3.21) \quad J_+v_1 = h(\rho)v_2$$

on  $\widetilde{M}_T^+ \cap \widetilde{M}_\Sigma^+$  for a suitable choice of smooth positive function  $h$ . Likewise, on  $\widetilde{M}_T^+ \cap \widetilde{M}_P^+$ , writing  $s = F_+(\rho) = 0$ ,  $t = G_+(\rho) = -\rho$  and  $\beta(G_+(\rho)) = 0$  gives  $\Lambda_+ = m d\phi$  and  $\Omega_+ = -\frac{1}{K}e^{-\rho}d\rho \wedge d\theta$ , so  $v_2$  reduces to the form  $b(\rho)\partial_\theta$  with  $b(\rho) < 0$ . It follows that  $v_1$  and  $v_2$  are negative multiples of  $\partial_t$  and  $\partial_\theta$  respectively, implying via (3.20) that (3.21) is again valid for a suitable choice of positive function  $h(\rho)$ . We can thus use (3.21) to extend  $J_+ : \Xi_+ \rightarrow \Xi_+$  over the rest of  $\widetilde{M}_T^+$  by extending  $h$  arbitrarily to a smooth positive function on  $(-1, 1)$ . For certain computations we will find it convenient to impose one further condition on the function  $h(\rho)$  for  $\rho \in (1/4, 1)$ , in particular on the ‘‘interpolation’’ region  $\{1/4 < \rho < 1/2\}$ . Here we have  $\Lambda_+ = m d\phi + \frac{1}{K}e^{-\rho}\beta(-\rho) d\theta$  and thus  $\Lambda_+(v_2) = ma(\rho) + \frac{1}{K}e^{-\rho}\beta(-\rho)b(\rho) = 0$ ,

implying  $b(\rho) \neq 0$ , or in other words,  $v_2$  must always have a nontrivial  $\partial_\theta$ -component. We are therefore free to choose  $h(\rho)$  to produce the obvious extension of (3.20) into this region; since  $\partial_\rho = -\partial_t$ , (3.21) then becomes

$$(3.22) \quad J_+ \partial_\rho = -\partial_\theta + \frac{1}{Km} e^{-\rho} \beta(-\rho) \partial_\phi \quad \text{on } \{1/4 < \rho < 1\} \subset \widetilde{M}_T^+.$$

With the choices above in place,  $J_+ \in \mathcal{J}(\mathcal{H}_+)$  now determines an  $\omega_E$ -compatible almost complex structure on  $\widehat{N}_+(\partial E) \subset \widehat{E}$ , which will next be extended to the rest of  $\widehat{E}$ . In order to obtain holomorphic vertebrae, we start by making a careful choice of  $J_+$  on the open subset (see Figure 6)

$$\widehat{V} := (-1, -1/2) \times \widehat{\Sigma} \times S^1 \subset \widehat{N}(\partial_h E) \subset \widehat{E}.$$

Writing tangent spaces at points  $(t, z, \theta) \in \widehat{V}$  as  $T_{(t,z,\theta)} \widehat{E} = T_z \widehat{\Sigma} \oplus \text{Span}(\partial_t, \partial_\theta)$  we set

$$J_+(t, z, \theta)|_{T_z \widehat{\Sigma}} := j(z), \quad J_+(t, z, \theta) \partial_t = \partial_\theta.$$

Note that since  $\partial_r = \partial_s$  and  $R_+ = R_0 = \frac{1}{m} \partial_\phi^\# = \frac{1}{m} \partial_\phi$  on  $\widehat{V} \cap \widehat{N}_+(\partial E)$ , this is consistent with the existing definition of  $J_+$  on  $\widehat{N}_+(\partial E)$ . The following observation is immediate.

**Proposition 3.8.** *For each connected component  $\dot{\Sigma}_0 \subset \widehat{\Sigma}$  and each  $(t, \theta) \in (-1, -1/2) \times S^1$ , the surface*

$$\{t\} \times \dot{\Sigma}_0 \times \{\theta\} \subset \widehat{V} \subset \widehat{E}$$

*is the image of a properly embedded  $J_+$ -holomorphic curve whose intersection with the cylindrical end  $\widehat{N}_+(\partial E)$  is a union of positive trivial half-cylinders over simply covered closed orbits of  $R_+$ .  $\square$*

The  $J_+$ -holomorphic curves in the above proposition will be referred to henceforward as **holomorphic vertebrae**.

A natural extension of  $J_+$  into the region

$$(-1, 0] \times \widetilde{M}_P^+ \subset \mathcal{N}(\partial_v E)$$

is defined by requiring  $J_+$  to be invariant under the flow of  $\partial_s$  on  $(-1, \infty) \times \widetilde{M}_P^+ \subset \widehat{N}(\partial_v E)$ . Note that this is also compatible with previous choices on the intersection of this region with  $\widehat{V}$ .

At this point, we have defined  $J_+$  everywhere on  $\widehat{E}$  except in the region of  $\widehat{N}(\partial_h E)$  bounded between  $\{t = -1/2\}$  and  $M^+$ ; this is roughly the region between the dark and light shading in Figure 6. The purpose of the next two lemmas is to find an extension of  $J_+$  to this region that will also fit into an almost Stein structure.

**Lemma 3.9.** *On the region where  $J_+$  has been defined so far, it satisfies*

$$-df_+ \circ J_+ = \lambda_+$$

*for a suitable smooth function  $f_+ : \widehat{E} \rightarrow \mathbb{R}$  and 1-form  $\lambda_+$  on  $\widehat{E}$  such that:*

- (1)  $d\lambda_+$  is symplectic and compatible with the orientation of  $\widehat{E}$ ;
- (2)  $df_+(V') > 0$  everywhere, where  $V'$  denotes the vector field dual to  $\lambda_+$ , i.e. defined by  $d\lambda_+(V', \cdot) \equiv \lambda_+$ ;
- (3)  $\lambda_+ = \frac{1}{K} \lambda_K$  on  $\widehat{N}(\partial_h E)$ , and the restrictions of  $\lambda_+$  and  $\frac{1}{K} \lambda_K$  to the vertical subbundle  $V\widehat{E}$  match everywhere;
- (4)  $\lambda_+$  restricts to  $M^-$  as a contact form inducing a contact structure isotopic to  $\xi_-$ .

*Proof.* We begin by finding a function  $f_+$  that satisfies  $-df_+ \circ J_+ = \frac{1}{K}\lambda_K$ , or equivalently  $\frac{1}{K}\lambda_K \circ J_+ = df_+$ , on the regions where  $J_+$  has been defined so far.

On  $[0, \infty) \times \widetilde{M}_\Sigma^+ \subset \widehat{\mathcal{N}}_+(\partial E)$  this is easy because, as we saw in the proof of Lemma 3.7,  $\frac{1}{K}\lambda_K = e^r \Lambda_+$ . Since any  $J_+ \in \mathcal{J}(\mathcal{H}_+)$  automatically satisfies

$$(e^r \Lambda_+) \circ J_+ = d(e^r),$$

we are free to fix  $f_+ := e^r$  on this region.

On  $[0, \infty) \times \widetilde{M}_\Sigma^+ \subset \widehat{\mathcal{N}}_+(\partial E)$  the same computation is valid and produces  $f_+ = e^r$  wherever  $\frac{1}{K}\lambda_K = e^r \Lambda_+$ , which is still true for  $\rho \leq 1/4$  but ceases to be true in  $\{1/4 < \rho < 1\}$ , so here a more careful computation is required. Since  $F_+(\rho) = 0$  and  $G_+(\rho) = -\rho$  in this region, we have  $\Omega_+ = -\frac{1}{K}e^{-\rho} d\rho \wedge d\theta$  and  $\Lambda_+ = m d\phi + \frac{1}{K}e^{-\rho}\beta(-\rho) d\theta$ , hence  $R_+ = \frac{1}{m}\partial_\phi$ , and  $J_+$  is determined by (3.22). In the mean time  $\frac{1}{K}\lambda_K = me^s d\phi + \frac{1}{K}e^t d\theta$ , with the  $s$  and  $t$  coordinates related to  $r$  and  $\rho$  via the embedding defined in Lemma 3.7, namely

$$s = r, \quad t = -\rho + \log[(e^r - 1)\beta(-\rho) + 1].$$

Evaluating  $\frac{1}{K}\lambda_K \circ J_+$  on the unit vectors in  $(r, \rho, \phi, \theta)$ -coordinates then leads to the formula

$$\frac{1}{K}\lambda_K \circ J_+ = e^r dr - \frac{1}{K}e^{-\rho} [1 - \beta(-\rho)] d\rho = df_+,$$

where  $f_+ := e^r - \frac{1}{K}g(\rho)$ , with

$$g(\rho) := \int_0^\rho e^{-x} [1 - \beta(-x)] dx.$$

The details of  $g(\rho)$  are unimportant beyond the following two observations: first, it is non-negative, and strictly positive for all  $\rho \geq 1/2$ ; second, its derivative for  $\rho \geq 1/2$  is  $e^{-\rho}$ , so using the alternative coordinates  $s = r$  and  $t = -\rho$  on this region, we can rewrite  $f_+$  as

$$f_+ = e^s + \frac{1}{K}(e^t - c)$$

for some constant  $c \in \mathbb{R}$  such that  $e^t - c < 0$  for all  $t \in (-1, -1/2]$ .

The above function can now be extended over  $\widehat{\mathcal{V}}$  using the  $j$ -convex function  $\varphi : \widehat{\Sigma} \rightarrow \mathbb{R}$ , which we recall satisfies  $-d\varphi \circ j = \sigma$  and  $\varphi(s, \phi) = e^s$  on  $\widehat{\mathcal{N}}(\partial\Sigma)$ . Indeed, the function

$$f_+ := \varphi + \frac{1}{K}(e^t - c)$$

on  $\widehat{\mathcal{V}}$  has the property  $-df_+ \circ J_+ = \sigma + \frac{1}{K}e^t d\theta = \frac{1}{K}\lambda_K$ . Moreover, since  $\varphi$  is subharmonic and equals 1 on  $\partial\Sigma$ , it is strictly less than 1 on the interior of  $\Sigma$ , implying that  $f_+ < 1$  on the portion of  $\widehat{\mathcal{V}}$  disjoint from  $\widehat{\mathcal{N}}_+(\partial E)$ . Since  $V_K = V_\sigma + \partial_t$ , it follows that  $f_+$  can be extended over the rest of  $\widehat{\mathcal{N}}(\partial_h E)$  satisfying  $df_+(V_K) > 0$ .

We will next extend  $f_+$  as a  $J_+$ -convex function to  $\widehat{\mathcal{N}}(\partial_v E) \setminus \widehat{\mathcal{N}}(\partial_v E \cap \partial_h E)$ , which includes the rest of  $\widehat{\mathcal{N}}_+(\partial E)$ . For this we can use the Thurston trick for almost Stein structures, as in [LVW, §2.4] or the appendix of [BV15]. Recall that in §3.3 we chose a function  $f_{\text{fib}} : M_P \rightarrow \mathbb{R}$  that matches  $e^t$  in  $\mathcal{N}(\partial M_P)$  and is fiberwise  $J_+$ -convex; composing this function with the projection  $\widehat{\mathcal{N}}(\partial_v E) \supset (-1, \infty) \times M_P \rightarrow M_P$  gives a function

$$f_{\text{fib}} : (-1, \infty) \times M_P \rightarrow \mathbb{R}$$

such that  $\partial_s f_{\text{fib}} \equiv 0$ ,  $f_{\text{fib}}(s, \phi, t, \theta) = e^t$  for  $t \in (-1, -1/2]$  and the 1-form

$$\lambda_{\text{fib}} := -df_{\text{fib}} \circ J_+$$

is fiberwise Liouville (outside the region  $\{t > -1/2\}$ , which we are free to ignore for this discussion). Moreover, the restriction of  $\lambda_{\text{fib}}$  to the vertical subspaces matches our construction of  $\lambda$  from §3.3. Now observe that since  $\partial_r = \partial_s$  and  $J_+ \partial_r = R_+$  is a horizontal lift of the unit vector field in  $S^1$ , the projection  $\Pi_v$  maps the region in question *holomorphically* to  $(-1, \infty) \times S^1$  with its standard complex structure  $i$ , thus

$$-d(e^s \circ \Pi_v) \circ J_+ = \Pi_v^*(-d(e^s) \circ i) = e^s d\Pi_v = \sigma.$$

Extending  $f_+$  by  $f_+ = e^s + \frac{1}{K} f_{\text{fib}}$ , it follows that

$$\lambda_+ := -df_+ \circ J_+ = \sigma + \frac{1}{K} \lambda_{\text{fib}},$$

and by the usual application of the Thurston trick as in [LVW, BV15],  $d\lambda_+$  is symplectic if  $K > 0$  is sufficiently large. We are free to assume this, since none of the other data on the region in question depends on the value of  $K$ . Note that by the same argument that was used previously for  $V_K$  (see Lemma 3.3), we can also assume after increasing  $K > 0$  that the dual Liouville vector field  $V'$  satisfies  $ds(V') > 0$  everywhere on  $\widehat{\mathcal{N}}(\partial_v E)$ . Since  $\lambda_+ = \frac{1}{K} \lambda_K$  in  $\widehat{\mathcal{N}}(\partial_h E)$  by construction, we also have  $V' = V_K$  in this region, so that  $V'$  is manifestly transverse to  $M^-$ , implying that  $\lambda_+|_{TM^-}$  is contact. Moreover, this contact form on  $M^-$  has been constructed in the same manner as a Giroux form for the spinal open book, implying that the induced contact structure is isotopic to  $\xi_-$ .  $\square$

The next result is of a much more general nature.

**Lemma 3.10.** *Assume  $(W, \omega)$  is a smooth symplectic manifold with a Liouville vector field  $V_\lambda$  that is nowhere zero, and denote the dual Liouville form by  $\lambda$  (i.e.  $d\lambda = \omega$  and  $\omega(V_\lambda, \cdot) = \lambda$ ). Suppose  $f : W \rightarrow \mathbb{R}$  is a smooth function satisfying  $df(V_\lambda) > 0$ . Then*

$$\xi := \ker df \cap \ker \lambda \subset TW$$

*is a smooth symplectic subbundle of codimension 2, and there is a natural homeomorphism*

$$\mathcal{J}(\lambda, f) \rightarrow \mathcal{J}(\xi, \omega) : J \mapsto J|_\xi,$$

*where  $\mathcal{J}(\lambda, f)$  denotes the space of  $\omega$ -compatible almost complex structures  $J$  on  $W$  satisfying  $\lambda = -df \circ J$ , and  $\mathcal{J}(\xi, \omega)$  is the space of compatible complex structures on the symplectic vector bundle  $(\xi, \omega)$ . In particular, it follows that  $\mathcal{J}(\lambda, f)$  is nonempty and contractible.*

*Proof.* The fact that  $\lambda$  is Liouville and  $df(V_\lambda) > 0$  implies that  $\lambda$  restricts as a contact form to each level set of  $f$ ; the subbundle  $\xi$  is then the union of all the resulting contact structures in the level sets. We claim first that any  $J \in \mathcal{J}(\lambda, f)$  preserves  $\xi$  and thus has a restriction  $J|_\xi$  in  $\mathcal{J}(\xi, \omega)$ . Indeed, if  $\lambda = -df \circ J$  then  $v \in \ker \lambda$  implies  $Jv \in \ker df$  and  $v \in \ker df$  implies  $Jv \in \ker \lambda$ , so this proves the claim. Now let  $R_\lambda$  denote the unique vector field on  $W$  satisfying

$$df(R_\lambda) \equiv 0, \quad \lambda(R_\lambda) \equiv 1, \quad d\lambda(R_\lambda, \cdot)|_\xi \equiv 0,$$

i.e.  $R_\lambda$  restricts to each level set of  $f$  as the Reeb vector field determined by  $\lambda$ . Then the relation  $\lambda = -df \circ J$  and the fact that  $\omega$  is  $J$ -invariant (since  $J$  is  $\omega$ -compatible) imply that the vector field  $\frac{1}{df(V_\lambda)} JV_\lambda$  satisfies the same conditions that define  $R_\lambda$ , hence

$$JV_\lambda = df(V_\lambda)R_\lambda.$$

This relation defines the inverse of the map  $\mathcal{J}(\lambda, f) \rightarrow \mathcal{J}(\xi, \omega) : J \mapsto J|_\xi$ .  $\square$

Using the Liouville form  $\lambda_+$  and Lyapunov function  $f_+$  on  $\widehat{E}$  supplied by Lemma 3.9, we can now use Lemma 3.10 to extend  $J_+$  over the rest of  $\widehat{E}$  such that  $\lambda_+ = -df_+ \circ J_+$  and  $J_+$  is  $d\lambda_+$ -compatible, hence  $f_+$  is  $J_+$ -convex. Note that Lemma 3.10 allows for considerable freedom in the choice of this extension, and we shall only need to impose one further condition:

$$J_+ \text{ is } S^1\text{-invariant on } \widehat{\mathcal{N}}(\partial_h E) = (-1, \infty) \times \widehat{\Sigma} \times S^1.$$

Here  $S^1$ -invariance means invariance with respect to the coordinate  $\theta \in S^1$ ; the assumption is already satisfied on the portions of  $\widehat{\mathcal{N}}(\partial_h E)$  where  $J_+$  has been defined so far, and it is possible on the rest because  $\lambda_K$ ,  $\widehat{\mathcal{V}}$  and  $M^+$  are all  $S^1$ -invariant objects, and so is  $f_+$  without loss of generality.

For applications to almost Stein fillings, we will take  $\eta = 0$  and our symplectic form on  $\widehat{E}$  is thus the exterior derivative of the Liouville form  $\frac{1}{K}\lambda_K$ . We now have a minor headache however because the model almost Stein structure  $(J_+, f_+)$  arising from the above construction produces another Liouville structure  $\lambda_+ = -df_+ \circ J_+$ , which is in general different from  $\frac{1}{K}\lambda_K$ , in particular they differ on  $\widehat{\mathcal{N}}(\partial_v E)$ . In order to define a useful notion of energy for holomorphic curves in this setting, we will need the following interpolation.

**Lemma 3.11.** *There exists a Liouville form  $\Theta$  on  $\widehat{E}$  with the following properties:*

- (1)  $\Theta = \lambda_+$  on  $E$ ;
- (2)  $\Theta = \frac{1}{K}\lambda_K$  on  $[T, \infty) \times M^+ \subset \widehat{\mathcal{N}}_+(\partial E)$  for  $T > 0$  sufficiently large;
- (3)  $d\Theta$  tames  $J_+$ .

*Proof.* We set  $\Theta = \lambda_+$  on  $\widehat{\mathcal{N}}(\partial_h E)$  since  $\lambda_+$  and  $\frac{1}{K}\lambda_K$  already match on this region. On  $\widehat{\mathcal{N}}(\partial_v E)$ , choose  $\Theta$  to be of the form

$$\Theta = [1 - g(s)] \frac{1}{K}\lambda_K + g(s)\lambda_+$$

for some smooth function  $g : (-1, \infty) \rightarrow [0, 1]$  with  $g(s) = 1$  for  $s \leq 0$  and  $g(s) = 0$  for  $s$  sufficiently large. We then have

$$(3.23) \quad d\Theta = [1 - g(s)] \frac{1}{K} d\lambda_K + g(s)d\lambda_+ + g'(s) ds \wedge \left( \lambda_+ - \frac{1}{K}\lambda_K \right).$$

Recall that  $J_+$  is tamed by both  $\frac{1}{K}d\lambda_K$  and  $d\lambda_+$ ; it is compatible with the former by construction, and it is tamed by the latter because  $\lambda_+ = -df_+ \circ J_+$  where  $f_+$  is  $J_+$ -convex. It follows that the interpolation forming the first two terms in (3.23) is also a nondegenerate 2-form taming  $J_+$ ; moreover, the construction of  $\lambda_+$  and  $\lambda_K$  guarantees that it tames  $J_+$  in a uniform way as  $s \rightarrow \infty$ . It therefore suffices to choose  $g$  changing slowly enough so that the  $g'(s)$  term in (3.23) does not ruin nondegeneracy, and this can be done at the cost of achieving the condition  $g(s) = 0$  only for  $s \geq T$  with  $T$  sufficiently large.  $\square$

**3.8. Holomorphic pages.** The main advantage of choosing  $J_+$  compatible with the stable Hamiltonian structure  $\mathcal{H}_+ = (\Omega_+, \Lambda_+)$  instead of contact data is that the pages of  $\pi$  can be lifted to properly embedded  $J_+$ -holomorphic curves in  $\widehat{\mathcal{N}}_+(\partial E)$ . Since  $J_+$  on  $\widehat{\mathcal{N}}_+(\partial E) = [0, \infty) \times M^+$  belongs to  $\mathcal{J}(\mathcal{H}_+)$ , we can equally well regard  $J_+$  as an  $\mathbb{R}$ -invariant almost complex structure on  $\mathbb{R} \times M^+$ , and we will now use it to construct a  $J_+$ -holomorphic foliation on  $\mathbb{R} \times M^+$ .

Denote by  $T\mathcal{F}_+$  the 2-dimensional distribution on  $\mathbb{R} \times M^+$  defined by

$$(T\mathcal{F}_+)_{(r,x)} = \begin{cases} \Xi_+ & \text{for } x \in \widetilde{M}_P^+, \\ \text{Span}\{\partial_\theta, J_+\partial_\theta\} & \text{for } x \in \widetilde{M}_T^+ \cup \widetilde{M}_\Sigma^+. \end{cases}$$

This distribution is smooth and  $J_+$ -invariant; indeed,  $\Xi_+$  is necessarily  $J_+$ -invariant since  $J_+ \in \mathcal{J}(\mathcal{H}_+)$ , and since  $\Xi_+$  matches the vertical subbundle of  $\pi_P : M_P \rightarrow S^1$  on  $\widetilde{M}_P^+$ , it also is spanned by  $\partial_\theta$  and  $J_+\partial_\theta$  in the collar where the  $\theta$ -coordinate is defined. It is also easy to see that  $T\mathcal{F}_+$  is  $\mathbb{R}$ -invariant, and it is *integrable*: the latter is obvious in  $\mathbb{R} \times \widetilde{M}_P^+$ , and everywhere else it follows from the fact that  $J_+$  is  $S^1$ -invariant, as this implies

$$(3.24) \quad [\partial_\theta, J_+\partial_\theta] \equiv 0.$$

Denote by  $\mathcal{F}_+$  the set of leaves of the foliation on  $\mathbb{R} \times M^+$  tangent to  $T\mathcal{F}_+$ . The next result shows that each of these leaves is the image of an embedded asymptotically cylindrical  $J_+$ -holomorphic curve as defined in §2.2, hence  $\mathcal{F}_+$  is a *finite energy foliation* in the sense of Hofer-Wysocki-Zehnder [HWZ03]. In the following, we use the Riemannian metric

$$\langle \cdot, \cdot \rangle := d\sigma(\cdot, j\cdot)$$

on  $\Sigma$  in order to define the gradient vector field  $\nabla H$  of  $H : \Sigma \rightarrow [0, \infty)$ . Observe that on the collar  $\mathcal{N}(\partial\Sigma)$ , since  $\sigma = me^s d\phi$  and  $j\partial_s = \frac{1}{m}\partial_\phi$  for the appropriate multiplicity  $m \in \mathbb{N}$ , we have  $d\sigma(\cdot, j\cdot) = e^s (ds \otimes ds + m^2 d\phi \otimes d\phi)$ , while  $H(s, \phi)$  depends only on the  $s$ -coordinate, thus  $\nabla H$  points in the  $s$  direction, orthogonal to  $\partial\Sigma$ . The Hamiltonian vector field  $X_H$  determined on  $(\Sigma, d\sigma)$  by  $H$  can now be written as

$$(3.25) \quad X_H = j\nabla H.$$

**Proposition 3.12.** *The leaves of the  $\mathbb{R}$ -invariant foliation  $\mathcal{F}_+$  are the images of asymptotically cylindrical  $J_+$ -holomorphic curves. In fact, each leaf of this foliation is one of the following:*

- (1) A **trivial cylinder**  $\mathbb{R} \times \gamma$ , where  $\gamma \subset M^+$  is a closed Reeb orbit of the form  $\gamma = \{z\} \times S^1 \subset \widetilde{M}_\Sigma^+ \subset \Sigma \times S^1$  for some  $z \in \text{Crit}_M(H)$ .
- (2) A **holomorphic gradient flow cylinder**, admitting a (not necessarily holomorphic) parametrization  $u : \mathbb{R} \times S^1 \hookrightarrow \mathbb{R} \times M^+$  of the form

$$u(s, t) = (a(s), \ell(s), t) \in \mathbb{R} \times \widetilde{M}_\Sigma^+ \subset \mathbb{R} \times \Sigma \times S^1,$$

where  $a : \mathbb{R} \rightarrow \mathbb{R}$  is a strictly increasing proper function and  $\ell : \mathbb{R} \rightarrow \Sigma$  is a solution of the gradient flow equation  $\dot{\ell} = \nabla H(\ell)$  approaching two distinct critical points of  $H$  as  $s \rightarrow \pm\infty$ .

- (3) A **holomorphic page**, which is a connected and properly embedded submanifold formed as a union of subsets of the following type:
  - $\{s\} \times P \subset \mathbb{R} \times \widetilde{M}_P^+$ , where  $s \in \mathbb{R}$  is a constant and  $P \subset \widetilde{M}_P^+$  is the portion of a page of  $\pi_P : M_P \rightarrow S^1$  lying in  $\widetilde{M}_P^+$ ;
  - Annuli admitting (not necessarily holomorphic) parametrizations  $u : (-1, 1) \times S^1 \hookrightarrow \mathbb{R} \times M^+$  of the form

$$u(s, t) = (a(s), s, \phi, t) \in \mathbb{R} \times (-1, 1) \times S^1 \times S^1 \subset \mathbb{R} \times \widetilde{M}_T^+$$

for some bounded functions  $a : (-1, 1) \rightarrow \mathbb{R}$  and constants  $\phi \in S^1$ ;

- *Half-cylinders admitting (not necessarily holomorphic) parametrizations  $u : [0, \infty) \times S^1 \hookrightarrow \mathbb{R} \times M^+$  of the form*

$$u(s, t) = (a(s), \ell(s), t) \in \mathbb{R} \times \widetilde{M}_\Sigma^+ \subset \mathbb{R} \times \Sigma \times S^1,$$

where  $a : [0, \infty) \rightarrow \mathbb{R}$  is a strictly increasing proper function and  $\ell : [0, \infty) \rightarrow \Sigma$  is a solution of the gradient flow equation  $\dot{\ell} = \nabla H(\ell)$  that begins at time  $s = 0$  as a trajectory in  $\mathcal{N}(\partial\Sigma)$  orthogonal to  $\partial\Sigma$  and approaches a critical point of  $H$  as  $s \rightarrow \infty$ .

In particular, each of the holomorphic gradient flow cylinders and pages projects through  $\mathbb{R} \times M^+ \rightarrow M^+$  to an embedded surface in  $M^+$  whose closure is a compact embedded surface bounded by Reeb orbits in  $\text{Crit}_M(H) \times S^1 \subset \widetilde{M}_\Sigma^+$ .

*Proof.* At any point  $(z, \theta) \in \text{Crit}_M(H) \times S^1$ ,  $\partial_\theta$  is proportional to  $R_+$ , hence  $J_+ \partial_\theta$  is proportional to  $\partial_r$  and the trivial cylinder  $\mathbb{R} \times \gamma \subset \mathbb{R} \times M^+$  over the periodic orbit  $\gamma$  through  $(z, \theta)$  therefore forms an integral submanifold of the distribution. Similarly, each integral submanifold in  $\mathbb{R} \times \widetilde{M}_P^+$  is contained in a set of the form  $\{s\} \times P \subset \mathbb{R} \times M_P$ , with  $s \in \mathbb{R}$  a constant and  $P \subset M_P$  a page of  $\pi$ . To complete the proof, we mainly need to justify the following two claims:

- At any point  $(z, \theta) \in \widetilde{M}_\Sigma^+ \subset \Sigma \times S^1$ , there exist  $a, b, c \in \mathbb{R}$  with  $c \neq 0$  such that

$$(3.26) \quad J_+ \partial_\theta = a \partial_\theta + b \partial_r + c \nabla H.$$

- At any point  $(\rho, \phi, \theta) \in \widetilde{M}_T^+$ , there exist  $b, c \in \mathbb{R}$  with  $c \neq 0$  such that

$$(3.27) \quad J_+ \partial_\theta = b \partial_r + c \partial_\rho.$$

To verify (3.26), we first observe that since  $\partial_\theta$  is transverse to  $\Xi_+$  on  $\widetilde{M}_\Sigma^+ \subset \Sigma \times S^1$ , there exist unique functions  $P, Q : \Sigma \rightarrow \mathbb{R}$  such that

$$\nabla H + P \partial_\theta \in \Xi_+ \quad \text{and} \quad j \nabla H + Q \partial_\theta \in \Xi_+,$$

and the definition of  $J_+$  in terms of  $j$  via the natural fiberwise isomorphism  $\Xi_+ \rightarrow T\Sigma$  then implies  $J_+(\nabla H + P \partial_\theta) = j \nabla H + Q \partial_\theta$ . By (3.13) and (3.25), we then have

$$J_+(\nabla H + P \partial_\theta) = -\frac{1}{\varepsilon} e^{\varepsilon H} R_+ + \left( Q + \frac{1 + \varepsilon \sigma(X_H)}{\varepsilon} K \right) \partial_\theta,$$

and applying  $-J_+$  to both sides yields

$$\nabla H + P \partial_\theta = -\frac{1}{\varepsilon} e^{\varepsilon H} \partial_r - \left( Q + \frac{1 + \varepsilon \sigma(X_H)}{\varepsilon} K \right) J_+ \partial_\theta.$$

The coefficient in front of  $J_+ \partial_\theta$  cannot be zero since  $\nabla H$ ,  $\partial_\theta$  and  $\partial_r$  are not linearly dependent, so this allows us to write  $J_+ \partial_\theta$  in the form (3.26) as claimed. In fact, we obtain the following precise formula for  $T\mathcal{F}_+$  in this region,

$$(3.28) \quad T\mathcal{F}_+ = \text{Span} \left\{ \partial_\theta, \nabla H + \frac{1}{\varepsilon} e^{\varepsilon H} \partial_r \right\} \quad \text{on } \mathbb{R} \times \widetilde{M}_\Sigma^+,$$

which shows that the functions  $a(s)$  appearing in parametrizations of leaves in  $\mathbb{R} \times \widetilde{M}_\Sigma^+$  are strictly increasing.



The proof of (3.27) follows similarly from our definition of  $J_+$  in  $\widetilde{M}_T^+$ . Here we have  $\partial_\rho \in \Xi_+$ , with  $R_+$  given by (3.15), and Lemma 3.6 implies that  $R_+$  and  $\partial_\theta$  are always linearly independent, so they span the same subbundle as  $\partial_\phi$  and  $\partial_\theta$ . This implies

$$J_+ \partial_\rho \in \text{Span}(\partial_\theta, \partial_\phi) = \text{Span}(\partial_\theta, R_+),$$

and thus  $J_+ \partial_\rho = a \partial_\theta + b R_+$  for some  $a, b \in \mathbb{R}$  with  $a \neq 0$ . Applying  $J_+$  to both sides of this gives the desired result.  $\square$

In the following, we shall often blur the distinction between leaves of  $\mathcal{F}_+$  and the corresponding unparametrized holomorphic curves, referring to both via parametrizations  $u : \dot{S} \rightarrow \mathbb{R} \times M^+$ . We will examine the analytical properties of the curves in  $\mathcal{F}_+$  more closely in §4.

Identifying  $[0, \infty) \times M^+ \subset \mathbb{R} \times M^+$  in the usual way with  $\widehat{N}_+(\partial E) \subset \widehat{E}$ ,  $\mathcal{F}_+$  also determines a foliation on  $\widehat{N}_+(\partial E)$ , which we shall extend into  $\widehat{E}$  by setting

$$T\mathcal{F}_+ := \begin{cases} \text{Span}\{\partial_\theta, J_+ \partial_\theta\} & \text{in } \widehat{N}(\partial_h E), \\ V\widehat{E} & \text{everywhere else.} \end{cases}$$

Indeed:

**Proposition 3.13.** *The distribution  $T\mathcal{F}_+$  on  $\widehat{E}$  is  $J_+$ -invariant and integrable, and matches the vertical subbundle  $VE$  on a neighborhood of  $M^-$ . Moreover,  $T\mathcal{F}_+$  is transverse to the hypersurfaces  $\{t = \text{const}\}$  in  $\widehat{N}(\partial_h E)$ .*

*Proof.* Integrability follows from (3.24) since  $J_+$  is  $S^1$ -invariant in  $\widehat{N}(\partial_h E)$ , and  $J_+$ -invariance is also immediate because  $J_+$  was defined to preserve the vertical subbundle outside of  $\widehat{N}(\partial_h E)$ . The transversality claim follows from the fact that  $J_+$  is  $\omega_E$ -tame and  $\omega_E = d\sigma + \frac{1}{K} e^t dt \wedge d\theta$  in  $\widehat{N}(\partial_h E)$ , thus

$$0 < \omega_E(\partial_\theta, J_+ \partial_\theta) = -\frac{1}{K} e^t dt(J_+ \partial_\theta).$$

$\square$

Figure 7 shows a picture of the foliation on  $\widehat{E}$ , plus a single holomorphic vertebra (see Prop. 3.8) that intersects every leaf positively.

**3.9. Large subdomains with weakly contact boundary.** The construction in the present subsection will be needed in the final step of the proofs of Theorems 1.5 and 1.10, in order to show that our  $J$ -holomorphic foliation obtained by analytical methods gives rise to a bordered Lefschetz fibration with supported symplectic structure in the sense of [LVW, §2.3]. The goal is to exhaust  $\widehat{E}$  by bounded subdomains

$$\widehat{E}_R \subset \widehat{E}, \quad \widehat{E} = \bigcup_{R>0} \widehat{E}_R$$

such that each  $\partial \widehat{E}_R$  is a weakly contact hypersurface (with corner) deformation equivalent to  $(M^-, \xi_-)$  and a neighborhood of  $\partial \widehat{E}_R$  in  $\widehat{E}_R$  looks like the neighborhood of the boundary in a bordered Lefschetz fibration with fibers given by leaves of  $\mathcal{F}_+$ .

Fix a pair of numbers  $c > 0$  and  $\delta \in (1/4, 1/2)$ , and define a smooth hypersurface  $M^c \subset \widehat{N}_+(\partial E)$  with nonempty boundary via the following conditions (see Figure 8):

- (1)  $M^c$  contains  $\{c\} \times \widetilde{M}_P^+ \subset [0, \infty) \times M^+ = \widehat{N}_+(\partial E)$ ;
- (2)  $M^c$  is a union of subsets of leaves of  $\mathcal{F}_+$ ;

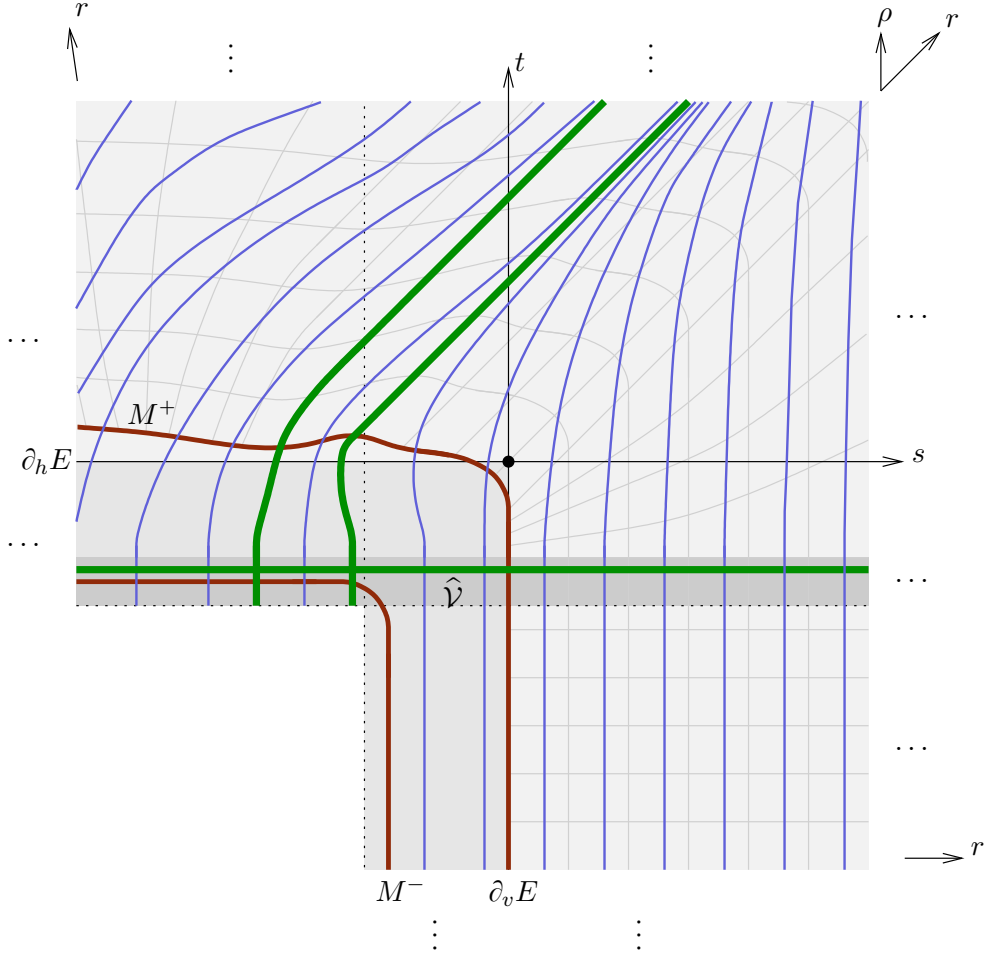

FIGURE 7. The  $J_+$ -holomorphic foliation  $\mathcal{F}_+$  in  $\widehat{E}$ . The picture includes two special leaves whose intersections with the cylindrical end  $\widehat{\mathcal{N}}_+(\partial E) = [0, \infty) \times M^+$  are trivial cylinders over Reeb orbits corresponding to critical points of  $H : \Sigma \rightarrow \mathbb{R}$ , and all other leaves approach these cylinders asymptotically at infinity. All leaves are also intersected transversely by a holomorphic vertebra in the region  $\widehat{\mathcal{V}}$ .

$$(3) \partial M^c \subset \{\rho = \delta\} \subset [0, \infty) \times \widetilde{M}_T^+.$$

It will be useful to note that  $M^c$  is  $\theta$ -invariant in the region near its boundary where the  $\theta$ -coordinate is defined. By adjusting  $\delta$  appropriately, one can also assume that  $\beta(-\delta) > 0$  and that  $M^c$  is everywhere transverse to the Liouville vector field  $V_K$ ; the latter follows from the formula  $V_K = \partial_s + \partial_t$  in the diagonal end, as we are free to assume by moving  $\delta$  closer to the region where  $\beta(-\rho) = 0$  that the tangent spaces to  $M^c$  are always  $C^0$ -close to those of the “vertical” hypersurfaces  $\{c\} \times \widehat{M}_P$ . The key consequence of the condition  $\beta(-\delta) > 0$  is the following: by (3.18), we have

$$\partial_r = \partial_s + \frac{e^r \beta(-\rho)}{(e^r - 1)\beta(-\rho) + 1} \partial_t$$

in the region  $1/4 < \rho < 1/2$ , so  $\beta(-\rho) > 0$  implies that the flow of  $\partial_r$  moves positively in the  $t$ -coordinate. In particular, given  $R > 0$ , we can find a number  $r_1 > 0$  such that if  $\Phi_{\partial_r}^t$  denotes the time  $t$  flow of  $\partial_r$ ,

$$\partial(\Phi_{\partial_r}^{r_1}(M^c)) \subset \{R\} \times \widehat{M}_\Sigma \subset \widehat{\mathcal{N}}(\partial_h E).$$

With this understood, define  $\widehat{E}_R \subset \widehat{E}$  to be the region in  $\widehat{E}$  bounded by  $\Phi_{\partial_r}^{r_1}(M^c) \subset \widehat{\mathcal{N}}(\partial_v E)$  and  $\{R\} \times \widehat{M}_\Sigma \subset \widehat{\mathcal{N}}(\partial_h E)$ . Its boundary has two smooth faces  $\partial \widehat{E}_R = \partial_v \widehat{E}_R \cup \partial_h \widehat{E}_R$ , where

$$\partial_v \widehat{E}_R = \Phi_{\partial_r}^{r_1}(M^c) \subset \widehat{\mathcal{N}}(\partial_v E),$$

and

$$\partial_h \widehat{E}_R \subset \{R\} \times \widehat{M}_\Sigma \subset \widehat{\mathcal{N}}(\partial_h E).$$

The  $\mathbb{R}$ -invariance of the foliation  $\mathcal{F}_+$  implies that  $\partial_v \widehat{E}_R$  is a union of 1-parameter families of compact subsets of leaves of  $\mathcal{F}_+$ .

**Lemma 3.14.** *For each  $R > 0$ , there exists a smooth isotopy of  $\widehat{E}_R$  to  $E$  through domains with the property that both smooth faces of their boundaries are weakly contact hypersurfaces in  $(E, \omega_E)$  with the contact structure induced by  $\lambda_K$ , and the corner of each is contained in  $\widehat{\mathcal{N}}(\partial_v E \cap \partial_h E)$ .*

*Proof.* Since  $\omega_E$  is exact in  $\widehat{\mathcal{N}}(\partial_h E)$  with Liouville vector field  $V_K = V_\sigma + \partial_t$ , the contact-type property for  $\partial_h \widehat{E}_R$  is immediate. The weakly contact property for  $\partial_v \widehat{E}_R$  follows mostly from Lemma 3.4; we only need to examine the ‘‘bent’’ region near the boundary of  $\partial_v \widehat{E}_R$  slightly more closely. Since this region also lies in  $\widehat{\mathcal{N}}(\partial_h E)$ , it suffices to check that  $\partial_v \widehat{E}_R$  is transverse to  $V_K = \partial_s + \partial_t$ . We have explicitly assumed this to be true for  $M^c$ , so we need to show that it remains true after flowing  $M^c$  by  $\partial_r$ , particularly in the region  $\{1/4 < \rho < 1/2\}$ , where the flow is given by (3.18). We can assume each tangent space to  $M^c$  in the relevant region is spanned by  $\partial_\phi$ ,  $\partial_\theta$  and  $\partial_t + a\partial_s$  for some  $a \in \mathbb{R}$  with  $|a|$  small. The flow of  $\partial_r$  does not change the first two vectors in this frame, and its change to the third one stretches the  $t$ -direction but not the  $s$ -direction. Thus as long as  $\delta$  has been chosen to make  $|a|$  sufficiently small, flowing by  $\partial_r$  cannot make these tangent spaces tangent to  $\partial_s + \partial_t$ ; moreover, one sees from this discussion that  $\partial_v \widehat{E}_R$  is isotopic to a subset of  $\{s_0\} \times \widehat{M}_P \subset \widehat{\mathcal{N}}(\partial_v E)$  for some constant  $s_0 > 0$ , through a family of weakly contact hypersurfaces that are all transverse to  $V_K$  and have fixed boundary. One can then define a suitable isotopy to  $E$  through domains bounded by hypersurfaces of the form  $\{\text{const}\} \times \widehat{M}_\Sigma \subset \widehat{\mathcal{N}}(\partial_h E)$  and  $\{\text{const}\} \times \widehat{M}_P \subset \widehat{\mathcal{N}}(\partial_v E)$ .  $\square$

Figure 8 depicts the boundary faces of  $\partial \widehat{E}_R$  on the backdrop of the cylindrical end and holomorphic foliation from Figures 6 and 7 respectively. It also shows the collar neighborhoods  $\mathcal{N}(\partial_v \widehat{E}_R)$  and  $\mathcal{N}(\partial_h \widehat{E}_R)$  as described in the following lemma, carrying fibrations whose fibers are leaves of the foliation.

**Lemma 3.15.** *For each  $R > 0$ , the boundary faces of  $\widehat{E}_R$  admit collar neighborhoods*

$$\begin{aligned} \partial_v \widehat{E}_R &\subset \mathcal{N}(\partial_v \widehat{E}_R) \cong (-1, 0] \times \partial_v \widehat{E}_R \subset \widehat{E}_R, \\ \partial_h \widehat{E}_R &\subset \mathcal{N}(\partial_h \widehat{E}_R) \cong (-1, 0] \times \partial_h \widehat{E}_R \subset \widehat{E}_R, \end{aligned}$$

with fibrations

$$\Pi_v^R : \mathcal{N}(\partial_v \widehat{E}_R) \rightarrow (-1, 0] \times S^1, \quad \Pi_h^R : \mathcal{N}(\partial_h \widehat{E}_R) \rightarrow \Sigma$$

that satisfy the following conditions:

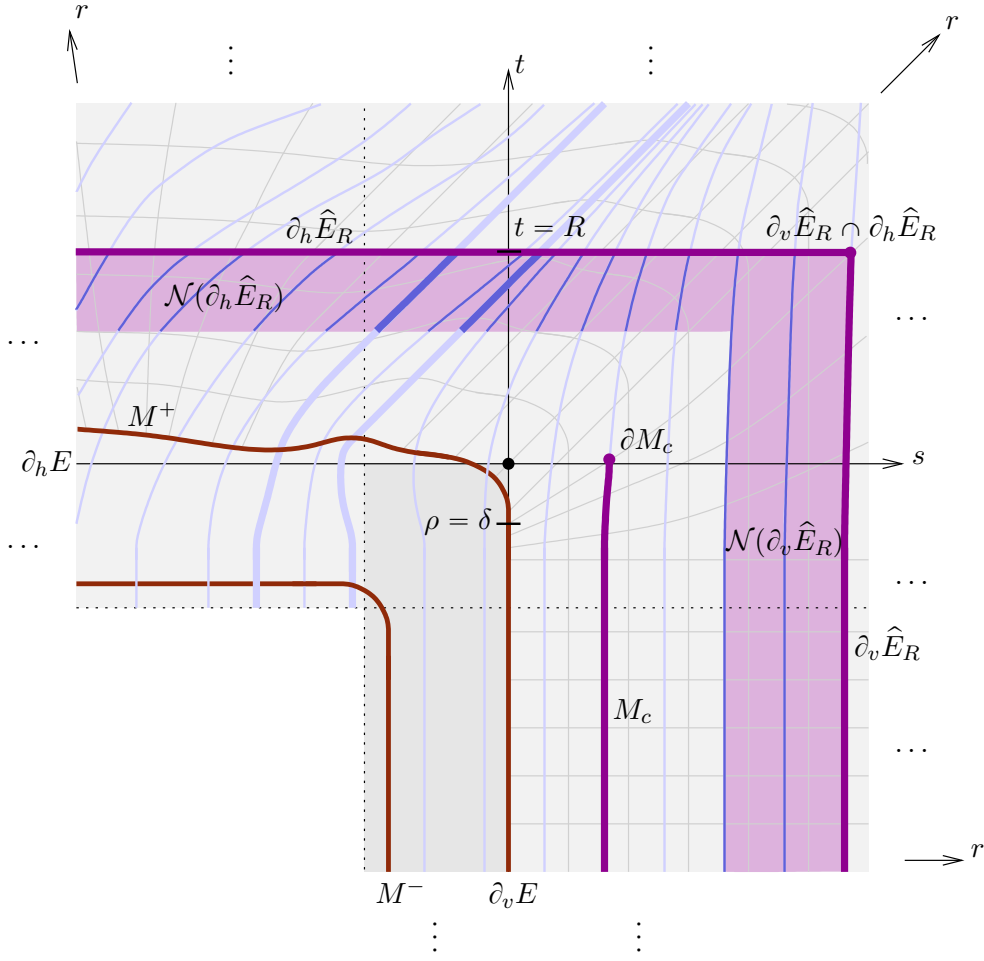

FIGURE 8. The construction of the region  $\hat{E}_R$  with boundary  $\partial \hat{E}_R = \partial_v \hat{E}_R \cup \partial_h \hat{E}_R$  and corner  $\partial_v \hat{E}_R \cap \partial_h \hat{E}_R$ , together with the collar neighborhoods  $\mathcal{N}(\partial_v \hat{E}_R)$ ,  $\mathcal{N}(\partial_h \hat{E}_R) \subset \hat{E}_R$ , which carry fibrations whose fibers are leaves of the holomorphic foliation from Figure 7.

- (1) The vertical subbundle for both fibrations is defined by the integrable distribution  $T\mathcal{F}_+$ .
- (2)  $\Pi_v^R$  is pseudoholomorphic near  $\partial_v \hat{E}_R$  with respect to  $J_+$  on  $\hat{E}$  and the standard complex structure on  $(-1, 0] \times S^1$ .
- (3) On  $\mathcal{N}(\partial_h \hat{E}_R)$ ,  $\omega_E$  has a primitive that restricts to a contact form on  $\partial_h \hat{E}_R$  for which the boundaries of the fibers of  $\Pi_h^R$  are closed Reeb orbits.

*Proof.* This is based essentially on four observations. First, the characteristic line field of  $\partial_h \hat{E}_R$  as a hypersurface in  $(\hat{E}, \omega_E)$  is spanned by  $\partial_\theta$ . Since  $J_+$  is  $\omega_E$ -compatible, it follows that  $J_+ \partial_\theta \in T\mathcal{F}_+$  is transverse to  $\partial_h \hat{E}_R$ , hence the leaves of  $\mathcal{F}_+$  intersect  $\partial_h \hat{E}_R$  transversely in loops tangent to  $\partial_\theta$ , and these are Reeb orbits for any contact form given by a primitive of  $\omega_E$ .

The second observation, which is clear already from the construction of  $\widehat{E}_R$ , is that  $\partial_v \widehat{E}_R$  is a union of (compact subsets of) leaves of  $\mathcal{F}_+$ , in particular it is a disjoint union of  $S^1$ -parametrized families of leaves. The collar  $\mathcal{N}(\partial_v \widehat{E}_R)$  with its fibration can therefore be obtained by extending these  $S^1$ -families to families parametrized by annuli.

Third, the foliation  $\mathcal{F}_+$  is invariant under flows in the  $r$ -direction, and in a neighborhood of  $\partial_v \widehat{E}_R$ , we have  $ds(\partial_r) = 1$ .

Finally,  $J_+$  satisfies  $J_+ \partial_r = R_+$  throughout  $\widehat{\mathcal{N}}_+(\partial E)$ , and in a neighborhood of  $\partial_v \widehat{E}_R$ , we can assume every point belongs to either  $[0, \infty) \times \widetilde{M}_P^+ \subset \widehat{\mathcal{N}}_+(\partial E)$  or the portion of  $[0, \infty) \times \widetilde{M}_T^+ \subset \widehat{\mathcal{N}}_+(\partial E)$  with  $\rho > 1/4$ , so that (3.8) and (3.15) give  $R_+ = e_{S^1}^\#$ , a horizontal lift of the canonical unit vector on  $S^1$  under the fibration  $\pi_P : M_P \rightarrow S^1$ . By the third observation above, it follows that  $\Pi_v^R : \mathcal{N}(\partial_v \widehat{E}_R) \rightarrow (-1, 0] \times S^1$  can be arranged such that near the boundary,  $\partial_r$  and  $J_+ \partial_r$  are horizontal lifts of the two canonical basis vector fields on  $(-1, 0] \times S^1$ , meaning  $\Pi_v^R$  is pseudoholomorphic.  $\square$

#### 4. HOLOMORPHIC CURVES IN SPINAL OPEN BOOKS

In this section we study  $J$ -holomorphic curves in the symplectization of a contact 3-manifold carrying a spinal open book. As we saw in §3, every spinal open book on a closed 3-manifold gives rise to a stable Hamiltonian structure and a compatible almost complex structure on its symplectization, for which the pages lift to a foliation by embedded  $J$ -holomorphic curves with positive ends approaching nondegenerate Reeb orbits in the spine. Our first task in this section will be write down the easy extension of this construction to the case of manifolds with boundary, and then to show that the stable Hamiltonian structure can be perturbed to a contact structure supported by the spinal open book. We then examine the analytical properties of the curves in the foliation, and show in particular that the *planar* curves among them are stable and will survive the perturbation from stable Hamiltonian to contact data; moreover, these will in fact be the *only* holomorphic curves with certain asymptotic behavior that exist after the perturbation. The most important results are Propositions 4.4 (existence), 4.10 and 4.11 (stability under perturbation), and 4.20 (uniqueness). These generalize results that were proved for open books in [Wen10d] and blown up summed open books in [Wen13], and will serve as crucial ingredients for the computations of contact invariants in §5 and compactness arguments in §6.

Throughout this section,  $(M', \xi)$  is a closed contact 3-manifold, and  $M = M_P \cup M_\Sigma \subset M'$  is a compact connected submanifold (possibly with boundary) carrying a spinal open book

$$\pi = \left( \pi_\Sigma : M_\Sigma \rightarrow \Sigma, \pi_P : M_P \rightarrow S^1, \{m_T\}_{T \subset \partial M} \right).$$

that admits a smooth overlap and supports  $\xi|_M$ .

**4.1. A family of stable Hamiltonian structures.** This subsection and the next will consist mostly of repackaged notation and results from §3. We shall use the notation from Section 3.1 for collar neighborhoods, and we also need to recall from [LVW, §2.2] the open covering

$$M = \widetilde{M}_\Sigma \cup \widetilde{M}_T \cup \widetilde{M}_P \cup \widetilde{M}_\partial$$

defined whenever  $M$  carries a spinal open book with smooth overlap. Here  $\widetilde{M}_P$  denotes the complement of the region  $\{t \geq -1/2\} \subset \mathcal{N}(\partial M_P)$  in  $M_P$ ,  $\widetilde{M}_\Sigma$  is the complement of  $\{s \geq -1/2\} \subset \mathcal{N}(\partial M_\Sigma)$  in  $M_\Sigma$ ,  $\widetilde{M}_T$  is the union of  $\mathcal{N}(\partial M_\Sigma)$  with the adjacent components of

$\mathcal{N}(\partial M_P)$ , and  $\widetilde{M}_\partial$  is the union of all components of  $\mathcal{N}(\partial M_P)$  that touch  $\partial M$ . The components of  $\widetilde{M}_\mathcal{I}$  carry coordinates

$$(\rho, \phi, \theta) \in (-1, 1) \times S^1 \times S^1 \subset \widetilde{M}_\mathcal{I}$$

which are related to the collar coordinates from §3.1 by  $\rho = s$  and  $\rho = -t$  on the regions of overlap, and components of  $\widetilde{M}_\partial$  similarly carry coordinates

$$(\rho, \phi, \theta) \in [0, 1) \times S^1 \times S^1 \subset \widetilde{M}_\partial$$

with  $\rho = -t$ . Since  $\mathcal{N}(\partial M_P)$  is contained in  $\widetilde{M}_\mathcal{I} \cup \widetilde{M}_\partial$ , we can use the coordinate  $\rho = -t$  as an alternative to  $t$  on  $\mathcal{N}(\partial M_P)$ .

Recall that in §3.1, the hypersurface  $M^0 \subset E$  was endowed with a similar open covering  $M^0 = \widetilde{M}_\Sigma^0 \cup \widetilde{M}_\mathcal{I}^0 \cup \widetilde{M}_P^0$ ; in the case  $\partial M = \emptyset$ , these three regions have obvious canonical identifications with  $\widetilde{M}_\Sigma$ ,  $\widetilde{M}_\mathcal{I}$  and  $\widetilde{M}_P$  respectively, thus defining a diffeomorphism  $M \cong M^0$ . This gives rise to a diffeomorphism of  $M$  with the hypersurface  $M^+ \subset \widehat{E}$  from §3.5 after flowing from  $M^0$  to  $M^+$  along the stabilizing vector field  $Z$ . The idea behind most of the definitions in this section is to use this identification of  $M$  with  $M^+$  in order to endow  $M$  with the same stable Hamiltonian structure that was defined in §3.5, and its symplectization likewise with the same almost complex structure as in §3.7. Only minor modifications will be needed for the case  $\partial M \neq \emptyset$ .

The following contact form on  $M$  takes on the role that was previously played by the restriction of  $\frac{1}{K}\lambda_K$  to  $M^+$ : define

$$\alpha := \begin{cases} e^{\varepsilon \widehat{H}} \left( \sigma + \frac{1}{K} d\theta \right) & \text{on } \widetilde{M}_\Sigma, \\ m e^{F_+(\rho)} d\phi + \frac{1}{K} e^{G_+(\rho)} d\theta & \text{on } \widetilde{M}_\mathcal{I}, \\ d\pi_P + \frac{1}{K} \lambda & \text{on } \widetilde{M}_P, \\ f_K(\rho) d\theta + m g(\rho) d\phi & \text{on } \widetilde{M}_\partial, \end{cases}$$

where the various symbols have the following meanings. The multiplicity  $m \in \mathbb{N}$  is a number that may vary among different connected components of  $\widetilde{M}_\mathcal{I} \cup \widetilde{M}_\partial$  (see §3.1), while  $\sigma$  is the pullback via  $\pi_\Sigma : M \rightarrow \Sigma$  of the Liouville form on  $\Sigma$  defined in §3.3,  $\lambda$  is the fiberwise Liouville form on  $M_P$  defined in the same subsection, and  $K > 0$  is the (arbitrarily) large constant that was used for building a Liouville form out of these ingredients via the Thurston trick. The functions  $\widehat{H} : \Sigma \times S^1 \rightarrow [0, \infty)$  and  $F_+, G_+ : (-1, 1) \rightarrow \mathbb{R}$  were defined for the perturbation of  $M^0$  to  $M^+$  in §3.5, which also depended on a constant  $\varepsilon > 0$  that may be assumed arbitrarily small. The only new pieces of data in our definition of  $\alpha$  are the functions  $f_K$  and  $g$  required for the collar near  $\partial M$ : to define these, we first choose smooth functions  $f, g : [0, 1) \rightarrow [0, 1]$  such that:

- $(f(\rho), g(\rho)) = (e^{-\rho}, 1)$  for  $\rho \geq 1/4$ ;
- $f g' - f' g > 0$ ;
- $f'(\rho) < 0$  for  $\rho > 0$ ;
- $(f(0), g(0)) = (1, 0)$ ,  $(f'(0), g'(0)) = (0, 1)$ , and  $f''(0) < 0$ .

The function  $f_K : [0, 1) \rightarrow [0, 1]$  is then defined by

$$f_K(\rho) := \left[ \beta(-\rho) \left( 1 - \frac{1}{K} \right) + \frac{1}{K} \right] f(\rho),$$

where  $\beta : (-1, 0] \rightarrow [0, 1]$  is the same cutoff function that was used in §3.4 to define a stabilizing vector field. It follows that  $f_K(\rho) = \frac{1}{K} f(\rho)$  for  $\rho \geq 1/2$ ,  $f_K(\rho) = f(\rho)$  for  $\rho \leq 1/4$ ,

and

$$f_K(\rho) = \left[ \beta(-\rho) \left( 1 - \frac{1}{K} \right) + \frac{1}{K} \right] e^{-\rho} \quad \text{for } \rho \geq 1/4,$$

hence  $f'_K(\rho) < 0$  for  $\rho \geq 1/4$ , so that  $f_K g' - f'_K g > 0$  everywhere.

For  $K > 0$  sufficiently large and  $\varepsilon > 0$  sufficiently small,  $\alpha$  is a Giroux form for  $\pi$ , so we can assume after adjusting  $\xi$  by an isotopy that  $\alpha$  extends to a contact form on  $M'$  with

$$\xi = \ker \alpha.$$

The Reeb vector field for  $\alpha$  will be denoted by  $R_\alpha$  and can be written as

$$(4.1) \quad R_\alpha = e^{-\varepsilon \hat{H}} ([1 + \varepsilon \sigma(X_H)] K \partial_\theta - \varepsilon X_H) \quad \text{on } \widetilde{M}_\Sigma,$$

where the Hamiltonian vector field  $X_H$  on  $\Sigma$  is defined by  $d\sigma(X_H, \cdot) = -dH$ . On the interface,  $R_\alpha$  satisfies

$$(4.2) \quad R_\alpha = \frac{1}{F'_+(\rho) - G'_+(\rho)} \left( -\frac{1}{m} e^{-F_+(\rho)} G'_+(\rho) \partial_\phi + K e^{-G_+(\rho)} F'_+(\rho) \partial_\theta \right) \quad \text{on } \widetilde{M}_\mathcal{I},$$

while near  $\partial M$ ,

$$(4.3) \quad R_\alpha = \frac{1}{f_K(\rho)g'(\rho) - f'_K(\rho)g(\rho)} \left( g'(\rho) \partial_\theta - \frac{f'_K(\rho)}{m} \partial_\phi \right) \quad \text{on } \widetilde{M}_\partial.$$

This last formula implies since  $f'(0) = 0$  that  $\partial M$  is foliated by closed Reeb orbits in the  $\theta$ -direction, and these orbits form Morse-Bott families due to the condition  $f''(0) < 0$ . Similarly, the assumption that  $H$  is Morse away from  $\partial\Sigma$  implies that Reeb orbits of the form  $\{z\} \times S^1$  for  $z \in \text{Crit}_M(H)$  are nondegenerate. Here we again denote by

$$\text{Crit}_M(H) \subset \Sigma$$

the finite set of Morse critical points of  $H$ , thus excluding the critical points in the region near  $\partial\Sigma$  where  $H$  vanishes.

The stable Hamiltonian structure from §3.5 can be written in the present context as  $\mathcal{H} = (\Omega, \Lambda)$ , where

$$\Omega := d\alpha + \frac{1}{KC} \eta$$

for some large constant  $C > 0$  and a closed 2-form  $\eta$  that is assumed to vanish outside of  $\widetilde{M}_P$ . The stabilizing 1-form is

$$\Lambda := \begin{cases} \alpha & \text{on } \widetilde{M}_\Sigma, \\ m e^{F_+(\rho)} d\phi + \frac{1}{K} e^{G_+(\rho)} \beta(G_+(\rho)) d\theta & \text{on } \widetilde{M}_\mathcal{I}, \\ d\pi_P & \text{on } \widetilde{M}_P, \\ \beta(-\rho) f(\rho) d\theta + m g(\rho) d\phi & \text{on } \widetilde{M}_\partial, \\ \alpha & \text{on } M \setminus M. \end{cases}$$

The only feature of this discussion that did not already appear in §3 is the definition of  $\mathcal{H}$  in  $\widetilde{M}_\partial$ , since we are now allowing  $\partial M \neq \emptyset$ . To see that  $(\Omega, \Lambda)$  satisfies the conditions of a stable Hamiltonian structure in this region, we need to check that  $\ker \Omega \subset \ker d\Lambda$ : this is

obvious whenever either  $\Lambda = d\pi_P$  or  $(\Omega, \Lambda) = (d\alpha, \alpha)$ , so we only still need to inspect the region where  $0 < \beta(-\rho) < 1$ , which means  $\rho \in (1/4, 1/2)$ . Here  $g(\rho) = 1$ , so

$$(4.4) \quad \begin{aligned} \Lambda &= \beta(-\rho)f(\rho) d\theta + m d\phi, \\ \Omega &= d(f_K(\rho) d\theta + m d\phi) = f'_K(\rho) d\rho \wedge d\theta \end{aligned}$$

in  $\{1/4 \leq \rho \leq 1/2\} \subset \widetilde{M}_\partial$ , implying that  $\ker d\Lambda$  and  $\ker \Omega$  are both generated by  $\partial_\phi$ . This shows that on the region in question,  $(\Omega, \Lambda)$  is indeed a stable Hamiltonian structure and its induced Reeb vector field is simply  $\frac{1}{m}\partial_\phi$ , which is the same as  $R_\alpha$ . For future reference it will be useful to note that the same result holds in the region  $\{1/4 \leq \rho \leq 1/2\} \subset \widetilde{M}_T$ , as here  $F_+(\rho) = 0$  and  $G_+(\rho) = -\rho$ , so that (4.4) is valid with  $f(\rho)$  replaced by  $e^{-\rho}$  and  $f_K(\rho)$  replaced by  $\frac{1}{K}e^{-\rho}$ . One can also see from this formula and the conditions imposed on  $\beta$  that  $\Lambda$  satisfies the contact condition as soon as  $\beta(-\rho) > 0$ , so in particular,  $\Lambda \wedge d\Lambda \geq 0$  and the induced hyperplane distribution

$$\Xi_0 := \ker \Lambda$$

is therefore a confoliation.

To summarize the discussion so far:

**Proposition 4.1.** *The pair  $\mathcal{H} = (\Omega, \Lambda)$  is a confoliation-type stable Hamiltonian structure on  $M'$ . Its induced Reeb vector field  $R_{\mathcal{H}}$  matches  $R_\alpha$  outside of  $\widetilde{M}_P$ , and is colinear with  $R_\alpha$  if  $\eta \equiv 0$ .  $\square$*

The possibly non-exact 2-form  $\eta$  is a harmless but necessary piece of the setup for applications to weak fillability, though in the present section we will be interested primarily in the case  $\eta \equiv 0$ . Our stable Hamiltonian structure then has some convenient extra properties arising from the fact that  $R_{\mathcal{H}}$  and  $R_\alpha$  are in this case colinear. This implies in the first place that in addition to the confoliation condition  $\Lambda \wedge d\Lambda \geq 0$ , we have

$$\Lambda \wedge d\alpha > 0 \quad \text{and} \quad \alpha \wedge d\Lambda \geq 0,$$

and therefore:

**Proposition 4.2.** *For every constant  $\tau \in [0, 1]$ , the pair*

$$\mathcal{H}_\tau := (\Omega_\tau, \Lambda_\tau) := (d\alpha, (1 - \tau)\Lambda + \tau\alpha)$$

*is a stable Hamiltonian structure on  $M'$  whose induced Reeb vector field is colinear with  $R_\alpha$ . Moreover,  $\mathcal{H}_0 = \mathcal{H}$  if  $\eta \equiv 0$ , while  $\Lambda_\tau = \alpha$  on  $\widetilde{M}_\Sigma$  for all  $\tau$ , and  $\Lambda_\tau$  is a contact form everywhere for  $\tau > 0$ , with an induced contact structure isotopic to  $\xi$ .  $\square$*

*Remark 4.3.* The reader should be cautioned that while the notation  $\mathcal{H}_\tau$  makes sense for  $\tau = 0$ ,  $\mathcal{H}_0$  under this definition is not the same SHS that was denoted this way in §3; it corresponds rather to what was previously denoted by  $\mathcal{H}_+$  in the case  $\eta \equiv 0$  and  $\partial M = \emptyset$ .

For each  $\tau \geq 0$ , we shall denote the induced hyperplane distribution and Reeb vector field for  $\mathcal{H}_\tau$  by  $\Xi_\tau$  and  $R_\tau$  respectively. Note that if  $\eta \neq 0$ , then  $R_0 \neq R_{\mathcal{H}}$  on  $\widetilde{M}_P$ , though  $\mathcal{H}$  does induce the same hyperplane distribution  $\Xi_0$  as  $\mathcal{H}_0$ . The scaling of  $R_\tau$  changes in general with the value of  $\tau$ , but its direction does not. Since  $\Lambda_\tau$  is contact for  $\tau > 0$ , Proposition 2.1 implies

$$\mathcal{J}(\mathcal{H}_\tau) = \mathcal{J}(\Lambda_\tau).$$



**4.2. The unperturbed finite energy foliation.** In this subsection we consider the unperturbed stable Hamiltonian structure  $\mathcal{H} = (\Omega, \Lambda)$  with  $\Omega = d\alpha + \frac{1}{K\mathcal{C}}\eta$ , where  $\eta$  is allowed to be nonzero in  $\widetilde{M}_P$ . Let us now rewrite the construction of the holomorphic foliation from §3.8 in the present context. Choose  $J_0 \in \mathcal{J}(\mathcal{H})$  to satisfy the same conditions as  $J_+ \in \mathcal{J}(\mathcal{H}_+)$  in §3.7 on the region  $\widetilde{M}_\Sigma \cup \widetilde{M}_\mathcal{I} \cup \widetilde{M}_P$ , while on  $\widetilde{M}_\partial$  it is determined by the same condition as on  $\widetilde{M}_\mathcal{I}$ , namely

$$J_0 v_1 = h(\rho) v_2$$

for some smooth function  $h(\rho) > 0$ , with  $v_1 := \partial_\rho$  and  $v_2$  denoting the unique linear combination of  $\partial_\phi$  and  $\partial_\theta$  that lies in  $\Xi_0$  and satisfies  $\Omega(v_1, v_2) = 1$ .

We can then define a smooth  $J_0$ -invariant and translation-invariant distribution  $T\mathcal{F}$  on  $\mathbb{R} \times M$  by

$$T\mathcal{F}_{(r,x)} := \begin{cases} \Xi_0 & \text{for } x \in \widetilde{M}_P, \\ \text{Span}(\partial_\theta, J_0 \partial_\theta) & \text{for } x \in \widetilde{M}_\Sigma \cup \widetilde{M}_\mathcal{I} \cup \widetilde{M}_\partial. \end{cases}$$

Using the metric  $\langle \cdot, \cdot \rangle := d\sigma(\cdot, j\cdot)$  on  $\Sigma$  to define the gradient  $\nabla H$  of  $H$ , Proposition 3.12 now adapts to the present setting as follows:

**Proposition 4.4.** *The distribution  $T\mathcal{F}$  is integrable, and thus defines an  $\mathbb{R}$ -invariant foliation  $\mathcal{F}$  on  $\mathbb{R} \times M$  whose leaves are the images of embedded and asymptotically cylindrical  $J_0$ -holomorphic curves. Each leaf of this foliation is one of the following:*

- (1) A **trivial cylinder**  $\mathbb{R} \times \gamma$ , where  $\gamma \subset M$  is either a nondegenerate Reeb orbit of the form  $\gamma = \{z\} \times S^1 \subset \widetilde{M}_\Sigma \subset \Sigma \times S^1$  for some  $z \in \text{Crit}_M(H)$ , or part of a Morse-Bott 2-torus of Reeb orbits in the  $\theta$ -direction foliating  $\partial M$ .
- (2) A **holomorphic gradient flow cylinder**, admitting a smooth (but not necessarily holomorphic) parametrization  $u : \mathbb{R} \times S^1 \hookrightarrow \mathbb{R} \times M$  of the form

$$u(s, t) = (a(s), \ell(s), t) \in \mathbb{R} \times \widetilde{M}_\Sigma \subset \mathbb{R} \times \Sigma \times S^1,$$

where  $a : \mathbb{R} \rightarrow \mathbb{R}$  is a strictly increasing proper function and  $\ell : \mathbb{R} \rightarrow \Sigma$  is a solution of the gradient flow equation  $\dot{\ell} = \nabla H(\ell)$  approaching two distinct critical points of  $H$  as  $s \rightarrow \pm\infty$ .

- (3) A **holomorphic page**, which is a connected and properly embedded submanifold formed as a union of subsets of the following type:

- $\{s\} \times P \subset \mathbb{R} \times \widetilde{M}_P$ , where  $s \in \mathbb{R}$  is a constant and  $P \subset \widetilde{M}_P$  is the portion of a page of  $\pi_P : M_P \rightarrow S^1$  lying in  $\widetilde{M}_P$ ;
- Annuli admitting smooth (but not necessarily holomorphic) parametrizations  $u : (-1, 1) \times S^1 \hookrightarrow \mathbb{R} \times M$  of the form

$$u(s, t) = (a(s), s, \phi, t) \in \mathbb{R} \times (-1, 1) \times S^1 \times S^1 \subset \mathbb{R} \times \widetilde{M}_\mathcal{I}$$

for some bounded function  $a : (-1, 1) \rightarrow \mathbb{R}$  and constant  $\phi \in S^1$ ;

- Half-cylinders admitting smooth (but not necessarily holomorphic) parametrizations  $u : [0, \infty) \times S^1 \hookrightarrow \mathbb{R} \times M$  of the form

$$u(s, t) = (a(s), \ell(s), t) \in \mathbb{R} \times \widetilde{M}_\Sigma \subset \mathbb{R} \times \Sigma \times S^1,$$

where  $a : [0, \infty) \rightarrow \mathbb{R}$  is a strictly increasing proper function and  $\ell : [0, \infty) \rightarrow \Sigma$  is a solution of the gradient flow equation  $\dot{\ell} = \nabla H(\ell)$  that begins at time  $s = 0$  as a trajectory in  $\mathcal{N}(\partial\Sigma)$  orthogonal to  $\partial\Sigma$  and approaches a critical point of  $H$  as  $s \rightarrow \infty$ ;

- *Half-cylinders admitting smooth (but not necessarily holomorphic) parametrizations  $u : [0, \infty) \times S^1 \hookrightarrow \mathbb{R} \times M$  of the form*

$$u(s, t) = (a(s), b(s), \phi, t) \in \mathbb{R} \times [0, 1) \times S^1 \times S^1 \subset \mathbb{R} \times \widetilde{M}_\partial$$

where  $a : [0, \infty) \rightarrow \mathbb{R}$  is a function with  $\lim_{s \rightarrow \infty} a(s) = +\infty$  and  $b : [0, \infty) \rightarrow (0, 1)$  is a strictly decreasing function with  $\lim_{s \rightarrow \infty} b(s) = 0$ .

In particular, each of the holomorphic gradient flow cylinders and pages projects through  $\mathbb{R} \times M \rightarrow M$  to an embedded surface in  $M$  whose closure is a compact embedded surface bounded by Reeb orbits in  $(\text{Crit}_M(H) \times S^1) \cup \partial M$ .

*Proof.* The only detail that has not been covered already by Proposition 3.12 is the behavior of the holomorphic pages as they approach  $\partial M$ . The relevant calculation here is the same as for  $\widetilde{M}_T$ , but carried out in  $\widetilde{M}_\partial$  instead, the key point being that everywhere in the interior of  $\widetilde{M}_\partial$ ,  $\text{Span}(\partial_\phi, \partial_\theta) = \text{Span}(\partial_\theta, R_{\mathcal{H}})$ , hence  $J_0 \partial_\theta$  is a linear combination of  $\partial_r$  and  $\partial_\rho$ . At  $\partial M$  this ceases to be true because  $R_{\mathcal{H}}$  is proportional to  $\partial_\theta$ , which implies that the trivial cylinders over orbits in  $\partial M$  are tangent to  $T\mathcal{F}$  and the interior leaves that approach  $\partial M$  are therefore properly embedded. Orientation considerations imply that the ends of those leaves are positive, as their projections to  $M$  are embedded surfaces with closures bounded by *positively* oriented Reeb orbits on  $\partial M$ .  $\square$

The foliation  $\mathcal{F}$  defines a finite energy foliation as in [HWZ03], but it is not generally a *stable* finite energy foliation, because the  $J_0$ -holomorphic curves forming its leaves may in general have negative Fredholm index and will thus die under small perturbations of the data. We will be examining issues of this type for the remainder of §4.

Each Morse critical point  $z \in \text{Crit}_M(H)$  gives rise to an embedded periodic Reeb orbit parametrized by

$$\gamma_z : S^1 \rightarrow M : t \mapsto (z, t) \in \widetilde{M}_\Sigma \subset \Sigma \times S^1.$$

This is also a periodic orbit of  $R_\tau$  for  $\tau > 0$  since  $\mathcal{H}_\tau = \mathcal{H}$  on  $\widetilde{M}_\Sigma$  for all  $\tau$ . We will denote the  $k$ -fold cover of this orbit for any  $k \in \mathbb{N}$  by

$$\gamma_z^k : S^1 \rightarrow M : t \mapsto \gamma_z(kt).$$

Observe that the natural  $S^1$ -action on  $\Sigma \times S^1$  induces a preferred trivialization of the contact bundle along  $\gamma_z$ . We shall denote the Conley-Zehnder index of  $\gamma_z^k$  with respect to this trivialization by

$$\mu_{\text{CZ}}(\gamma_z^k) \in \mathbb{Z},$$

and let  $\text{Morse}(z) \in \{0, 1, 2\}$  denote the Morse index of  $z \in \text{Crit}_M(H)$ .

**Lemma 4.5.** *There exists a number  $T_1 > 0$  such that for any  $T_0 > 0$ , the above construction can be arranged by choosing  $K > 0$  and  $\varepsilon > 0$  sufficiently large and small respectively so that the dynamics of  $R_{\mathcal{H}}$  have the following properties:*

- (1) *For each Morse critical point  $z \in \text{Crit}_M(H)$ , all orbits in a neighborhood of  $\gamma_z : S^1 \rightarrow \widetilde{M}_\Sigma$  are nondegenerate.*
- (2) *Every closed orbit with period less than  $T_1$  is of the form  $\gamma_z^k$  for some Morse critical point  $z \in \text{Crit}_M(H)$  and  $k \in \mathbb{N}$ , and all such orbits satisfy*

$$\mu_{\text{CZ}}(\gamma_z^k) = \text{Morse}(z) - 1.$$

- (3) *The orbits  $\gamma_z$  for  $z \in \text{Crit}_M(H)$  have period less than  $T_0$ .*
- (4) *The families of orbits that foliate  $\partial M$  are Morse-Bott.*

Moreover, we can also assume that the dynamics of  $R_\tau$  have these same properties for all  $\tau \geq 0$  sufficiently small.

*Proof.* Consider first the dynamics of  $R_{\mathcal{H}}$ . On  $\widetilde{M}_\Sigma$  we have  $R_{\mathcal{H}} = R_\alpha$ , so we see from (4.1) that periodic orbits in  $\widetilde{M}_\Sigma \setminus (\text{Crit}_M(H) \times S^1)$  correspond to nonconstant periodic orbits of the Hamiltonian vector field  $X_H$  on  $\Sigma$ , where  $X_H$  is scaled by  $\varepsilon$  and the periods of its orbits are therefore scaled by  $1/\varepsilon$ . (We can assume the additional scaling factor of  $e^{-\varepsilon \widehat{H}}$  is arbitrarily close to 1.) Since the periods of nonconstant orbits of  $X_H$  have positive infimum, we can make the scaled periods larger than any given  $T_1$  by choosing  $\varepsilon$  small. In  $\widetilde{M}_P$ , we have  $\Lambda = d\pi_P$  and thus all closed orbits of  $R_{\mathcal{H}}$  have period at least 1. In  $\widetilde{M}_I$ ,  $R_{\mathcal{H}}$  matches  $R_\alpha$  and is thus given by (4.2), so the condition  $G'_+ < 0$  from Lemma 3.6 implies that  $R_{\mathcal{H}}$  has a nonzero  $\partial_\phi$  component whose size does not depend on  $K$ ; one can therefore find a lower bound independent of  $K$  on the periods in  $\widetilde{M}_I$  and choose  $T_1 > 0$  smaller than this bound. A similar computation works in  $\widetilde{M}_\partial$  using (4.3), since  $f'_K(\rho) < 0$  for  $\rho > 0$  implies that  $R_\alpha$  has a positive  $\partial_\phi$ -component in the interior, and the dependence of the contact form on  $K$  is limited to the region  $\{\rho \geq 1/4\}$ , where the Reeb vector field is simply  $\frac{1}{m}\partial_\phi$ . The orbits that foliate  $\partial M$  have period 1 since  $f_K(0) = f(0) = g'(0) = 1$ . With this understood, let us assume henceforward that  $T_1$  is smaller than the periods of all orbits other than the  $\gamma_z$  for  $z \in \text{Crit}_M(H)$ . The periods of the latter can however be made arbitrarily small by increasing  $K$ .

The computation of the Conley-Zehnder index is a standard result from Floer theory, see for example [SZ92] or [Wenb, §10.3.2]. Similarly, the Morse-Bott condition at  $\partial M$  follows from the condition  $f''(0) < 0$ .

All of the above applies immediately to  $R_0$ , since this is the special case of  $R_{\mathcal{H}}$  with  $\eta \equiv 0$ . Considering the perturbations  $\mathcal{H}_\tau$  for  $\tau > 0$ , the same conclusions remain valid for  $R_\tau$  if  $\tau$  is sufficiently small: this is because the perturbation does not change the direction of the Reeb vector field, so the only change to the dynamics is a very slight change in the periods of closed orbits.  $\square$

From now on we will assume the data to be chosen so that Lemma 4.5 is satisfied for some constants  $T_0, T_1 > 0$ , for which we may assume  $T_1/T_0$  is as large as needed.

Lemma 4.5 provides enough information to compute the Fredholm indices of the leaves of  $\mathcal{F}$  by applying the Riemann-Roch formula to the normal bundles of the curves. This computation was carried out for the ordinary open book case in [Wen10d], and the result in our setting is:

**Proposition 4.6.** *Suppose  $u : \dot{S} \rightarrow \mathbb{R} \times M$  represents a holomorphic page in  $\mathcal{F}$  that has genus  $g \geq 0$  and  $k + n$  punctures, where  $k \geq 0$  of them are asymptotic to orbits  $\gamma_{z_1}, \dots, \gamma_{z_k}$  in  $\widetilde{M}_\Sigma$  for Morse critical points  $z_1, \dots, z_k \in \text{Crit}_M(H)$ , and the rest are asymptotic to Morse-Bott orbits in  $\partial M$ . Then*

$$(4.5) \quad \text{ind}(u) = 2 - 2g - \sum_{i=1}^k [2 - \text{Morse}(z_i)].$$

*If  $u : \mathbb{R} \times S^1 \rightarrow \mathbb{R} \times M$  represents a holomorphic gradient flow cylinder with positive end at  $\gamma_{z_+}$  and negative end at  $\gamma_{z_-}$  for  $z_\pm \in \text{Crit}_M(H)$ , then*

$$\text{ind}(u) = \text{Morse}(z_+) - \text{Morse}(z_-).$$

$\square$

We shall say that a leaf  $u \in \mathcal{F}$  is an **interior leaf** if all its asymptotic orbits are in  $\widetilde{M}_\Sigma$ , none in  $\partial M$ . This includes all the trivial cylinders over orbits in  $\text{Crit}_M(H) \times S^1$ , all gradient flow cylinders and all holomorphic pages that are modelled on pages with boundary contained in  $M_\Sigma$ .

Observe that if one starts from any point  $z \in \partial\Sigma$  and traces an inward curve in  $\mathcal{N}(\partial\Sigma)$ , orthogonal to the boundary, it soon becomes a gradient flow line that ends at a critical point of index either 1 or 2, and the former is the case only for finitely many starting points in  $\partial\Sigma$ . This implies that  $\mathcal{F}$  contains at most finitely many leaves (up to  $\mathbb{R}$ -translation) whose asymptotic orbits include index 1 critical points. The *generic* leaf is therefore either a holomorphic page with positive ends approaching orbits in  $\partial M$  and index 2 critical points, or a gradient flow cylinder connecting a critical point of index 0 to one of index 2. Since every component of  $\Sigma$  has nonempty boundary,  $H$  can always be chosen such that

$$\text{Morse}(z) \in \{1, 2\} \quad \text{for all } z \in \text{Crit}_M(H),$$

and we shall assume this from now on so that *all* generic leaves are holomorphic pages rather than gradient flow cylinders. The index formula (4.5) shows that only the *planar* holomorphic pages in  $\mathcal{F}$  can have positive index, and in general some of these may even have  $\text{ind}(u) \leq 0$  if they have multiple ends approaching index 1 critical points. This can be avoided by a generic perturbation of  $H$  and  $j$  away from the boundary to arrange the following conditions:

- (i)  $\nabla H$  is Morse-Smale,
- (ii) No two gradient flow lines approaching index 1 critical points enter  $\partial\Sigma$  at points with the same value of  $m\phi$ , where  $\phi$  denotes the usual collar coordinate at  $\partial\Sigma$  and  $m$  is the relevant multiplicity determined by the adjacent component of  $\pi_P : M_P \rightarrow S^1$  as in (3.1).

**Definition 4.7.** We will say that the pair  $(H, j)$  are in **general position** whenever  $H$  has no index 0 Morse critical points and both of the above conditions are satisfied.

Plugging in the index formulas above and applying the automatic transversality criterion from [Wen10b], we find:

**Lemma 4.8.** *If  $(H, j)$  are in general position, then every gradient flow cylinder and every holomorphic page with genus zero has index 1 or 2 and is Fredholm regular. Moreover, these are the only leaves of  $\mathcal{F}$  with positive index.*  $\square$

For later arguments in §5 and §6, we will also need some control over the indices of multiple covers of curves in  $\mathcal{F}$ , especially the trivial cylinders and gradient flow cylinders.

**Lemma 4.9.** *Suppose  $(H, j)$  are in general position, and  $u$  is a connected stable holomorphic building in  $\mathbb{R} \times M'$  with no nodes, with arithmetic genus  $g \geq 0$ , and whose connected components are all covers of leaves of  $\mathcal{F}$  contained in  $\mathbb{R} \times \widetilde{M}_\Sigma$ . Assume moreover that the sum of the periods of the positive asymptotic orbits of  $u$  is less than  $T_1$ . Then*

$$\text{ind}(u) = 2g - 2 + \#\Gamma_0^+ + 2\#\Gamma_1^+ + \#\Gamma_0^- ,$$

where  $\Gamma_0^\pm$  and  $\Gamma_1^\pm$  denote the sets of positive/negative punctures of  $u$  at which the asymptotic orbit has even or odd Conley-Zehnder index respectively. In particular:

- (1) *The index is nonnegative, with equality if and only if  $u$  is either a trivial cylinder or a building composed entirely of branched covers of trivial cylinders over an orbit  $\{z\} \times S^1$  with  $\text{Morse}(z) = 2$ , each connected component having exactly one positive puncture.*

- (2) If  $u$  is a cover of a gradient flow cylinder, then  $\text{ind}(u) \geq 1$ , with equality if and only if  $u$  itself is a cylinder and the cover is unbranched, in which case  $u$  is also Fredholm regular.

*Proof.* By Proposition 2.4, all the negative asymptotic orbits of  $u$  also have periods less than  $T_1$ , so fixing the  $S^1$ -invariant trivialization, the Conley-Zehnder indices of all asymptotic orbits are given by Lemma 4.5, i.e. they are 1 for punctures in  $\Gamma_1$  and 0 for the others. The index computation then follows easily from the standard formula (2.7) after observing that the relative first Chern number vanishes, as the  $S^1$ -invariant trivialization extends globally over  $\widetilde{M}_\Sigma$ : writing the Euler characteristic as  $2 - 2g - \#\Gamma$ , we thus obtain

$$\text{ind}(u) = -(2 - 2g - \#\Gamma) + \#\Gamma_1^+ - \#\Gamma_1^-,$$

which reduces to the stated formula.

To understand the consequences of this formula, observe first that we always have

$$(4.6) \quad \begin{aligned} \Gamma^+ \neq \emptyset \text{ and } \Gamma^- \neq \emptyset, \\ \#\Gamma_1^+ = 0 \quad \text{implies} \quad \#\Gamma_1^- = 0. \end{aligned}$$

Indeed, these statements follow from the fact that they manifestly hold for all of the trivial cylinders and gradient flow cylinders that constitute the somewhere injective curves covered by components of  $u$  (the second statement depends on the fact that  $\nabla H$  is Morse-Smale). Thus if  $\text{ind}(u) < 0$ , we necessarily have  $g = 0$  and  $\#\Gamma_1^+ = 0$ , implying  $\#\Gamma_1^- = 0$ , but then  $\#\Gamma_0^+$  and  $\#\Gamma_0^-$  must both be positive and we have a contradiction. The index must also be strictly positive if  $g \geq 1$  since  $\#\Gamma_0^+$  and  $\#\Gamma_1^+$  will never both be zero. Now suppose  $g = 0$  and  $\text{ind}(u) = 0$ . We have the following possibilities:

- (1) If  $\#\Gamma_0^+ = 2$ , then  $\#\Gamma_1^+ = \#\Gamma_0^- = 0$ , but the implication in (4.6) then gives  $\#\Gamma_1^- = 0$  and thus contradicts the fact that  $\Gamma^- \neq \emptyset$ .
- (2) If  $\#\Gamma_0^- = 2$ , then  $\#\Gamma_0^+ = \#\Gamma_1^+ = 0$ , which is impossible since  $\Gamma^+ \neq \emptyset$ .
- (3) If  $\#\Gamma_0^+ = \#\Gamma_0^- = 1$  and  $\#\Gamma_1^+ = 0$ , then (4.6) implies  $\#\Gamma_1^- = 0$ , so  $u$  is a trivial cylinder over an even orbit, meaning a cover of some  $\gamma_z$  with  $\text{Morse}(z) = 1$ .
- (4) If  $\#\Gamma_0^+ = \#\Gamma_0^- = 0$  and  $\#\Gamma_1^+ = 1$ , then no components of  $u$  can be covers of gradient flow cylinders since these always have even negative punctures, thus we have a building whose components are all covers of trivial cylinders over an odd orbit (hence  $\gamma_z$  with  $\text{Morse}(z) = 2$ ), and the building has exactly one positive puncture. Since  $g = 0$ , the latter implies that each of its components also has exactly one positive puncture.

Finally, applying the index formula to the case where  $u : \dot{S} \rightarrow \mathbb{R} \times \widetilde{M}_\Sigma$  is a cover of a gradient flow cylinder, we have  $\#\Gamma_0^+ = \#\Gamma_1^- = 0$  and thus

$$\begin{aligned} \text{ind}(u) &= 2g - 2 + 2\#\Gamma^+ + \#\Gamma^- = 2g - 2 + \#\Gamma + \#\Gamma^+ \\ &= -\chi(\dot{S}) + \#\Gamma^+, \end{aligned}$$

which equals at least 1 since  $\chi(\dot{S}) \leq 0$  and  $\#\Gamma^+ \geq 1$ . Equality then holds if and only if  $\dot{S}$  is a cylinder, and the Riemann-Hurwitz formula then implies that the cover is unbranched. Since  $u$  is immersed in this case, Fredholm regularity follows from the main result of [Wen10b].  $\square$

**4.3. Perturbation of stable leaves.** For the SFT and ECH computations in §5, we will need to perturb the planar holomorphic curves in  $\mathcal{F}$  as the confoliation  $\Xi_0$  changes to the

contact structure  $\Xi_\tau$  for  $\tau > 0$ . To this end, assume  $(H, j)$  are in general position, and denote

$$\mathcal{J}(M'; H) := \bigcup_{\mathcal{H}'} \mathcal{J}(\mathcal{H}'),$$

where the union is over all confoliation-type stable Hamiltonian structures  $\mathcal{H}'$  on  $M'$  that match  $\mathcal{H}$  on a neighborhood of  $\text{Crit}_M(H) \times S^1 \subset \widetilde{M}_\Sigma$ ; note that this is true in particular for all  $\mathcal{H}_\tau$  with  $\tau \geq 0$ . We assign to  $\mathcal{J}(M'; H)$  the natural  $C^\infty$ -topology as a subset of the space of all smooth translation-invariant almost complex structures on  $\mathbb{R} \times M'$ . Then for  $J \in \mathcal{J}(M'; H)$ , denote by

$$\mathcal{M}(J; H)$$

the moduli space of  $\mathbb{R}$ -equivalence classes of nonconstant, connected, unparametrized finite-energy  $J$ -holomorphic curves whose asymptotic orbits are all contained in  $\text{Crit}_M(H) \times S^1$ .<sup>5</sup> This moduli space is naturally contained in the corresponding space of stable  $J$ -holomorphic buildings as defined in [BEH<sup>+</sup>03],

$$\mathcal{M}(J; H) \subset \overline{\mathcal{M}}(J; H).$$

We shall consider the resulting *universal* moduli spaces

$$\begin{aligned} \mathcal{M}(\mathcal{J}(M'; H)) &:= \{(J, u) \mid J \in \mathcal{J}(M'; H), u \in \mathcal{M}(J; H)\}, \\ \overline{\mathcal{M}}(\mathcal{J}(M'; H)) &:= \{(J, u) \mid J \in \mathcal{J}(M'; H), u \in \overline{\mathcal{M}}(J; H)\}, \end{aligned}$$

which inherit natural topologies. Let

$$\mathcal{M}^{\mathcal{F}}(J_0) \subset \mathcal{M}(J_0; H)$$

denote the subset consisting of  $\mathbb{R}$ -equivalence classes of embedded curves whose images are leaves of the foliation  $\mathcal{F}$ . Its closure  $\overline{\mathcal{M}}^{\mathcal{F}}(J_0) \subset \overline{\mathcal{M}}(J_0; H)$  in the compactified moduli space consists of stable holomorphic buildings whose levels are likewise disjoint unions of leaves of  $\mathcal{F}$ . We will see in Lemma 4.17 that  $\overline{\mathcal{M}}^{\mathcal{F}}(J_0)$  is an open and closed subset of  $\overline{\mathcal{M}}(J_0; H)$ ; note that this is clear already for the components with arithmetic genus zero, due to Fredholm regularity (Lemma 4.8). Choose an open neighborhood

$$\overline{\mathcal{M}}^{\mathcal{F}}(\mathcal{J}(M'; H)) \subset \overline{\mathcal{M}}(\mathcal{J}(M'; H))$$

of  $\{J_0\} \times \overline{\mathcal{M}}^{\mathcal{F}}(J_0)$ , let  $\mathcal{M}^{\mathcal{F}}(\mathcal{J}(M'; H)) \subset \overline{\mathcal{M}}^{\mathcal{F}}(\mathcal{J}(M'; H))$  denote the open subset consisting of smooth 1-level curves with no nodes, and for each  $J \in \mathcal{J}(M'; H)$ , denote<sup>6</sup>

$$\begin{aligned} \mathcal{M}^{\mathcal{F}}(J) &:= \{u \in \mathcal{M}(J; H) \mid (J, u) \in \mathcal{M}^{\mathcal{F}}(\mathcal{J}(M'; H))\}, \\ \overline{\mathcal{M}}^{\mathcal{F}}(J) &:= \left\{ u \in \overline{\mathcal{M}}(J; H) \mid (J, u) \in \overline{\mathcal{M}}^{\mathcal{F}}(\mathcal{J}(M'; H)) \right\}. \end{aligned}$$

The components of each of these spaces consisting of curves or buildings with a prescribed index  $i \in \mathbb{Z}$  will be written as

$$\mathcal{M}_i^{\mathcal{F}}(J), \quad \overline{\mathcal{M}}_i^{\mathcal{F}}(J), \quad \mathcal{M}_i^{\mathcal{F}}(\mathcal{J}(M'; H)), \quad \overline{\mathcal{M}}_i^{\mathcal{F}}(\mathcal{J}(M'; H)).$$

After shrinking the neighborhood  $\overline{\mathcal{M}}^{\mathcal{F}}(\mathcal{J}(M'; H))$  if necessary, we shall assume without loss of generality that the following conditions hold for all  $u \in \overline{\mathcal{M}}^{\mathcal{F}}(J)$ :

<sup>5</sup>See §2.2 for some clarifying remarks on moduli spaces of unparametrized finite-energy  $J$ -holomorphic curves and their topologies.

<sup>6</sup>To clarify: depending on the size of the neighborhood  $\overline{\mathcal{M}}^{\mathcal{F}}(\mathcal{J}(M'; H))$ , one should expect  $\mathcal{M}^{\mathcal{F}}(J)$  and  $\overline{\mathcal{M}}^{\mathcal{F}}(J)$  to be empty unless  $J$  is close to  $J_0$ . (The latter will of course be the main case of interest.)

- All components of levels in  $u$  are somewhere injective;
- If  $u$  has arithmetic genus zero, then all components of levels in  $u$  are Fredholm regular.

Both conditions follow from the fact that they are already known to hold for  $\overline{\mathcal{M}}^{\mathcal{F}}(J_0)$ . If additionally  $J \in \mathcal{J}(M'; H)$  is generic, then it now follows that  $\mathcal{M}_i^{\mathcal{F}}(J)$  is empty for all  $i \leq 0$ . With or without genericity, we can also conclude that  $\mathcal{M}_1^{\mathcal{F}}(J)$  and  $\mathcal{M}_2^{\mathcal{F}}(J)$  are smooth manifolds of dimensions 0 and 1 respectively (recall that we divided out the  $\mathbb{R}$ -action in defining these spaces). By inspection of the foliation  $\mathcal{F}$ , we see that  $\mathcal{M}_1^{\mathcal{F}}(J_0) = \overline{\mathcal{M}}_1^{\mathcal{F}}(J_0)$  has finitely many elements, and  $\overline{\mathcal{M}}_2^{\mathcal{F}}(J_0)$  is homeomorphic to a disjoint union of finitely many circles and compact intervals whose endpoints are 2-level buildings, both levels being unions of trivial cylinders with curves in  $\mathcal{M}_1^{\mathcal{F}}(J_0)$ . The implicit function theorem now implies that this description also holds for  $\overline{\mathcal{M}}_i^{\mathcal{F}}(J)$  whenever  $J$  is sufficiently close to  $J_0$ :

**Proposition 4.10.** *For all  $J \in \mathcal{J}(M'; H)$  sufficiently close to  $J_0$ , there exist families of homeomorphisms*

$$\Psi_J : \mathcal{M}_1^{\mathcal{F}}(J_0) \rightarrow \mathcal{M}_1^{\mathcal{F}}(J), \quad \Psi_J : \overline{\mathcal{M}}_2^{\mathcal{F}}(J_0) \rightarrow \overline{\mathcal{M}}_2^{\mathcal{F}}(J)$$

that depend continuously on  $J \in \mathcal{J}(M'; H)$  and satisfy  $\Psi_{J_0} = \text{Id}$ . In particular,  $\mathcal{M}_1^{\mathcal{F}}(J)$  contains finitely many elements, and  $\overline{\mathcal{M}}_2^{\mathcal{F}}(J)$  is homeomorphic to a disjoint union of finitely many circles and compact intervals whose endpoints consist of 2-level holomorphic buildings in which each level is a union of trivial cylinders with a curve in  $\mathcal{M}_1^{\mathcal{F}}(J)$ .

Moreover, if  $J$  is also generic, then  $\mathcal{M}_i^{\mathcal{F}}(J) = \emptyset$  for all  $i \leq 0$ .  $\square$

We obtain a stronger result in the special case where all pages are both interior and planar. The proof of the following will be postponed until the end of §4.4, since it requires a bit of intersection theory.

**Proposition 4.11.** *Assume  $\partial M = \emptyset$  and every page in  $M_P$  has genus zero. Then for  $J \in \mathcal{J}(M'; H)$  sufficiently close to  $J_0$ , the trivial cylinders over orbits in  $\text{Crit}_M(H) \times S^1$ , together with the curves in  $\mathcal{M}_1^{\mathcal{F}}(J) \cup \mathcal{M}_2^{\mathcal{F}}(J)$  foliate  $\mathbb{R} \times M$ , and thus form a stable finite energy foliation of  $(\mathbb{R} \times M, J)$ .*

**4.4. Intersection-theoretic properties.** We now examine the properties of the foliation  $\mathcal{F}$  and perturbed moduli spaces  $\mathcal{M}^{\mathcal{F}}(J)$  in terms of Siefring's intersection theory of punctured holomorphic curves (see §2.3). We shall assume throughout the following that the period bounds and index formula of Lemma 4.5 hold for some constants  $T_1 > T_0 > 0$ . We first observe the following immediate consequence of Lemma 4.5 and (2.8). Note that whenever  $\gamma$  is a nondegenerate Reeb orbit with  $\mu_{\text{CZ}}(\gamma) = 0$ , the same holds for all covers of  $\gamma$ .

**Lemma 4.12.** *For any  $z \in \text{Crit}_M(H)$  with Morse index 0 or 2 and  $k \in \mathbb{N}$  such that  $\gamma_z^k$  has period less than  $T_1$ , the extremal winding numbers  $\alpha_{\pm}(\gamma_z^k)$  behave as follows:*

- If  $\text{Morse}(z) = 2$ , then  $\alpha_{-}(\gamma_z^k) = 0$  and  $\alpha_{+}(\gamma_z^k) = 1$ .
- If  $\text{Morse}(z) = 0$ , then  $\alpha_{-}(\gamma_z^k) = -1$  and  $\alpha_{+}(\gamma_z^k) = 0$ .

Moreover if  $\text{Morse}(z) = 1$ , then  $\alpha_{-}(\gamma_z^k) = \alpha_{+}(\gamma_z^k) = 0$  for all  $k \in \mathbb{N}$ .  $\square$

**Lemma 4.13.** *For every  $J \in \mathcal{J}(M'; H)$  and  $u \in \mathcal{M}^{\mathcal{F}}(J)$ , if  $u$  is not a trivial cylinder, then  $c_N(u) = 0$  and  $u$  has zero asymptotic winding (in the  $S^1$ -invariant trivialization) at each puncture.*

*Proof.* For any leaf  $u \in \mathcal{F}$  which is not a trivial cylinder, the projection of  $u$  to  $M'$  is embedded and thus  $\text{wind}_\pi(u) = 0$ . Since each end of  $u$  is an  $S^1$ -invariant cover of a gradient flow line and thus has asymptotic winding zero, this winding is extremal by Lemma 4.12 and we have  $\text{def}_\infty(u) = 0$ . Then (2.12) implies  $c_N(u) = 0$ . Since  $c_N(u)$  depends only on the asymptotic orbits and relative homology class, it remains zero for any  $u \in \mathcal{M}^{\mathcal{F}}(J)$  which is not a trivial cylinder, so (2.12) then implies  $\text{def}_\infty(u) = 0$  and the result on asymptotic winding follows.  $\square$

**Lemma 4.14.** *Suppose  $k, m \in \mathbb{N}$ ,  $J \in \mathcal{J}(M'; H)$ ,  $u \in \mathcal{M}^{\mathcal{F}}(J)$  is not a trivial cylinder and  $u^k$  denotes any  $J$ -holomorphic  $k$ -fold cover of  $u$ . Then for any  $z \in \text{Crit}_M(H)$  and  $m \in \mathbb{N}$  such that  $\gamma_z^{km}$  has period less than  $T_1$ ,*

$$u^k * (\mathbb{R} \times \gamma_z^m) = 0.$$

*If  $\text{Morse}(z) = 1$ , then this also holds without any restriction on  $k, m \in \mathbb{N}$ .*

*Proof.* By homotopy invariance, it suffices to show that this holds for  $J = J_0$  and any leaf  $u \in \mathcal{F}$  which is not a trivial cylinder. The image of  $u^k$  then covers a gradient flow line wherever it intersects  $M_\Sigma$ , so  $u^k$  has no actual intersections with  $\mathbb{R} \times \gamma_z^m$ , and it remains to rule out asymptotic contributions. By the definition in [Sie11], these can exist only if  $u$  has an end approaching  $\gamma_z$ , in which case  $u^k$  has an end approaching  $\gamma_z^n$  for some  $n \leq k$ . Moreover, the asymptotic contribution is then zero if and only if the asymptotic winding of the  $m$ -fold cover of this end differs from the a priori bound set by  $\alpha_\pm(\gamma_z^{mn})$ . In the  $S^1$ -invariant trivialization, this asymptotic winding is manifestly zero, so in the case  $\text{Morse}(z) \in \{0, 2\}$ ,  $nm \leq km$  implies that  $\gamma_z^{mn}$  has period less than  $T_1$ , and Lemma 4.12 then gives  $\alpha_\pm(\gamma_z^{mn}) = 0$  for the appropriate choice of sign. For  $\text{Morse}(z) = 1$ , the same holds with no restrictions on multiplicities since  $\alpha_\pm(\gamma^k) = 0$  for all  $k \in \mathbb{N}$ .  $\square$

**Proposition 4.15.** *For any  $J \in \mathcal{J}(M'; H)$ , every curve  $u \in \mathcal{M}^{\mathcal{F}}(J)$  is embedded, and any two such curves  $u, v$  satisfy  $u * v = 0$  unless both are trivial cylinders.*

*Proof.* The proof of  $u * v = 0$  is immediate from Lemmas 2.10 and 4.14. If  $u$  is not a trivial cylinder, then this also implies  $u * u = 0$ , and since  $u$  is somewhere injective by the definition of  $\overline{\mathcal{M}}^{\mathcal{F}}(\mathcal{J}(M'; H))$ , it now follows from the adjunction formula (2.10) that  $u$  is nicely embedded, hence also embedded.  $\square$

**Lemma 4.16.** *Assume  $J \in \mathcal{J}(M'; H)$ , and  $v \in \overline{\mathcal{M}}(J; H)$  is a  $J$ -holomorphic curve whose positive ends are all asymptotic to orbits of the form  $\gamma_z^k$  with  $z \in \text{Crit}_M(H)$  and  $k \in \mathbb{N}$  having period less than  $T_1$ . Then for any curve  $u \in \mathcal{M}^{\mathcal{F}}(J)$  with no negative ends,  $v * u = 0$ .*

*Proof.* After an  $\mathbb{R}$ -translation we can assume the image of  $u$  is contained in  $[0, \infty) \times M$ . Likewise, we can homotop  $v$  through asymptotically cylindrical maps to a (non-holomorphic) map  $v'$  which looks the same near its negative ends but whose intersection with  $[0, \infty) \times M$  consists only of the trivial cylinders over its positive asymptotic orbits. Thus by the homotopy invariance of the intersection number,

$$v * u = v' * u = \sum_i (\mathbb{R} \times \gamma_{z_i}^{k_i}) * u,$$

for some finite set of critical points  $z_i \in \text{Crit}_M(H)$  and natural numbers  $k_i$  such that  $\gamma_{z_i}^{k_i}$  has period less than  $T_1$ . This is zero by Lemma 4.14.  $\square$

We are now in a position to prove Proposition 4.11.



*Proof of Proposition 4.11.* By Prop. 4.15, every curve in  $\mathcal{M}_1^{\mathcal{F}}(J) \cup \mathcal{M}_2^{\mathcal{F}}(J)$  is nicely embedded and disjoint from its own asymptotic orbits, and any two such curves are either identical (up to  $\mathbb{R}$ -translation) or disjoint; in fact the latter is also true for arbitrary  $\mathbb{R}$ -translations, implying that their projections to  $M$  are either identical or disjoint. It remains to show that these curves fill the entirety of  $M$ . Let  $\Delta \subset M$  denote the compact set consisting of all points that lie either in  $\text{Crit}_M(H) \times S^1$  or in the projection of any curve in  $\mathcal{M}_1^{\mathcal{F}}(J)$ . Also, let  $\mathcal{O} \subset M \setminus \Delta$  denote the set of points that lie in the projection of any curve in  $\mathcal{M}_2^{\mathcal{F}}(J)$ . Applying the implicit function theorem to finitely many index 2 leaves of  $\mathcal{F}$ , we find that for  $J$  sufficiently close to  $J_0$ , every connected component of  $M \setminus \Delta$  contains points in  $\mathcal{O}$ .

To finish, we claim that  $\mathcal{O}$  is an open and closed subset of  $M \setminus \Delta$ . To see that it is closed, suppose  $x_k \in \mathcal{O}$  converges to  $x \in M \setminus \Delta$ . Then the points  $x_k$  are contained in the projections of curves  $u_k \in \mathcal{M}_2^{\mathcal{F}}(J)$ , and these have a subsequence converging to either another curve  $u \in \mathcal{M}_2^{\mathcal{F}}(J)$  or a building  $u \in \overline{\mathcal{M}}_2^{\mathcal{F}}(J)$ . In the former case we conclude  $x \in \mathcal{O}$ , and in the latter case,  $u$  has two levels which are each unions of trivial cylinders with curves in  $\mathcal{M}_1^{\mathcal{F}}(J)$ , so  $x \in \Delta$  and we have a contradiction. That  $\mathcal{O}$  is open follows from an implicit function theorem for nicely embedded index 2 curves, cf. [Wen05, Theorem 4.5.44]. The main point is that since any  $u \in \mathcal{M}_2^{\mathcal{F}}(J)$  is embedded, the nearby curves in  $\mathcal{M}_2^{\mathcal{F}}(J)$  can all be identified with sections of the normal bundle of  $u$ , and the condition  $c_N(u) = 0$  from Lemma 4.13 implies that these sections must be nowhere zero, cf. [Wen10b, Equation (2.7)].  $\square$

**4.5. Uniqueness.** For any  $J \in \mathcal{J}(M'; H)$ , define the spaces

$$\mathcal{M}(J; H, T_1), \quad \overline{\mathcal{M}}(J; H, T_1)$$

to consist of all connected  $\mathbb{R}$ -equivalence classes of unparametrized finite energy  $J$ -holomorphic curves or buildings respectively in  $\mathbb{R} \times M'$  whose positive asymptotic orbits are in  $\text{Crit}_M(H) \times S^1$  and have periods adding up to less than  $T_1$ . Proposition 2.4 then implies that the same condition holds at the negative ends, thus all negative asymptotic orbits of curves in  $\mathcal{M}(J; H, T_1)$  or  $\overline{\mathcal{M}}(J; H, T_1)$  are also in  $\text{Crit}_M(H) \times S^1$  due to Lemma 4.5. We denote by

$$\mathcal{M}^*(J; H, T_1) \subset \mathcal{M}(J; H, T_1)$$

the set of somewhere injective curves in  $\mathcal{M}(J; H, T_1)$ . The following is now an easy consequence of the intersection theory from §4.4.

**Lemma 4.17.** *Every curve in  $\mathcal{M}^*(J_0; H, T_1)$  is an interior leaf of  $\mathcal{F}$ .*

*Proof.* Suppose  $u \in \mathcal{M}^*(J_0; H, T_1)$  is not a leaf of  $\mathcal{F}$ . By Prop. 2.4 it must have at least one positive puncture, which by assumption is asymptotic to an orbit of the form  $\gamma_z^k$  for  $z \in \text{Crit}_M(H)$  and  $k \in \mathbb{N}$ , with period less than  $T_1$ . All trivial cylinders over orbits in  $\text{Crit}_M(H) \times S^1$  are leaves of  $\mathcal{F}$ , so we may assume  $u$  is not a trivial cylinder. Then as  $u$  approaches  $\gamma_z^k$ , it has isolated intersections with infinitely many leaves of  $\mathcal{F}$ . In particular, we can find a *generic* leaf  $v \in \mathcal{F}$  with  $u * v > 0$ , i.e.  $v$  has no ends asymptotic to orbits  $\gamma_\zeta$  with  $\text{Morse}(\zeta) = 1$ . Since there are no index 0 critical points, this implies every end of  $v$  is positive. Then Lemma 4.16 implies  $u * v = 0$ , so we have a contradiction.  $\square$

To generalize the above lemma to the perturbation of  $J_0$ , we will need to specialize to the case where  $(M, \xi)$  is a partially planar domain, i.e. we assume there exists a connected component  $M_P^{\text{pln}} \subset M_P$  which has genus zero pages and does not touch  $\partial M$ .

*Remark 4.18.* If  $M_P^{\text{pln}} \subset M \setminus \partial M$  is a connected component of  $M_P$ , then we can always shrink  $M$  to a smaller subdomain on which  $\xi$  is still supported by a spinal open book containing the pages of  $M_P^{\text{pln}}$  in the interior, but with the additional property that every spinal component intersects  $M_P^{\text{pln}}$ . Indeed, if  $\Sigma_1 \times S^1 \subset M_\Sigma$  is any spinal component disjoint from  $M_P^{\text{pln}}$ , then since  $\xi$  is transverse to the  $S^1$ -direction at  $\partial(\Sigma_1 \times S^1)$ , we can replace  $M$  with a smaller domain whose boundary includes all components of  $\partial M_P$  that touch  $\Sigma_1 \times S^1$ , and assume after an isotopy of  $\xi$  that it is supported by a spinal open book on the shrunken domain (cf. [LVW, Example 1.11]).

By the above remark, we lose no generality by imposing the following conditions on our partially planar domain and the chosen geometric data:

**Assumptions 4.19.** *Suppose the spinal open book on  $(M, \xi)$ , the data  $H$  and  $j$  and constants  $K, \varepsilon > 0$  (cf. Lemma 4.5) satisfy the following conditions:*

- (1)  $M_P \subset M$  contains a connected component  $M_P^{\text{pln}}$  which has genus zero pages and  $\partial M_P^{\text{pln}} \subset M_\Sigma$ ;
- (2) Every page in the interior of  $M$  has fewer than  $T_1/T_0$  boundary components;
- (3) Every component of  $M_\Sigma$  intersects  $M_P^{\text{pln}}$ ;
- (4)  $H : \Sigma \rightarrow [0, \infty)$  has exactly one index 2 critical point on every connected component of  $\Sigma$ .

For the main result of this section, we consider sequences  $\tau_\nu > 0$  and  $J_\nu \in \mathcal{J}(\mathcal{H}_{\tau_\nu}) \subset \mathcal{J}(M'; H)$  such that

$$\tau_\nu \rightarrow 0 \quad \text{and} \quad J_\nu \rightarrow J_0.$$

**Proposition 4.20.** *If Assumptions 4.19 hold, then for  $\nu$  sufficiently large,  $\mathcal{M}^*(J_\nu; H, T_1) = \mathcal{M}^\mathcal{F}(J_\nu)$ .*

*Proof.* The claim that  $\mathcal{M}^\mathcal{F}(J_\nu) \subset \mathcal{M}^*(J_\nu; H, T_1)$  follows immediately from Assumptions 4.19 since every curve in  $\mathcal{M}^\mathcal{F}(J_\nu)$  has fewer than  $T_1/T_0$  ends, all approaching simply covered orbits in  $\text{Crit}_M(H) \times S^1$  with period less than  $T_0$ . We will prove the converse by showing that for  $\nu$  sufficiently large, the presence of the embedded planar curves in  $\mathcal{M}_2^\mathcal{F}(J_\nu)$  forces all other curves in  $\mathcal{M}^*(J_\nu; H, T_1)$  to be nicely embedded. Then the compactness theorem in [Wen10a] implies essentially that if  $\nu$  is large enough, then every such curve in  $\mathcal{M}^*(J_\nu; H, T_1)$  is a perturbation of a nicely embedded  $J_0$ -holomorphic building, whose components must be leaves of  $\mathcal{F}$  due to Lemma 4.17. Here are the details.

Arguing by contradiction, assume there is a sequence of  $J_\nu$ -holomorphic curves

$$u_\nu : \dot{S}_\nu \rightarrow \mathbb{R} \times M'$$

which define elements in  $\mathcal{M}^*(J_\nu; H, T_1) \setminus \mathcal{M}^\mathcal{F}(J_\nu)$  as  $\nu \rightarrow \infty$ . Since the trivial cylinders over orbits in  $\text{Crit}_M(H) \times S^1$  are all leaves of  $\mathcal{F}$ , we may assume  $u_\nu$  is never a trivial cylinder. After taking a subsequence, we may also assume that  $u_\nu$  has fixed numbers of positive and negative ends, always approaching the same collection of orbits; this follows from the period bound at the positive ends since there are finitely many combinations of orbits in  $\text{Crit}_M(H) \times S^1$  for which the required bound is satisfied.

*Step 1: Compactness.* We claim that a subsequence of  $u_\nu$  converges to a  $J_0$ -holomorphic building  $u_\infty$  whose connected components are all covers of interior leaves in  $\mathcal{F}$ . The convergence does not immediately follow from [BEH<sup>+</sup>03], for three reasons:

- (1) We must check that  $u_\nu$  satisfy a suitable energy bound as the contact structures  $\Xi_{\tau_\nu}$  degenerate to the confoliation  $\Xi_0$ .
- (2) We have not assumed any bound on the genus of  $\dot{S}_\nu$ .
- (3) The dynamics of  $R_0$  are degenerate.

The first issue is the main reason we have introduced the stable Hamiltonian structures  $\mathcal{H}_\tau = (\Omega_\tau, \Lambda_\tau)$ . A reasonable notion of energy can be defined by

$$E_\nu(u_\nu) := \sup_{\varphi \in \mathcal{T}} \int_{\dot{S}_\nu} u_\nu^* (d(\varphi(r)\Lambda_{\tau_\nu}) + \Omega_{\tau_\nu}),$$

where  $\mathcal{T}$  denotes the space of smooth strictly increasing functions  $\varphi : \mathbb{R} \rightarrow (-\delta, \delta)$  for some constant  $\delta > 0$  chosen sufficiently small to make sure that the integrand is nonnegative. This notion is equivalent to the energy defined in [BEH<sup>+</sup>03], in the sense that either satisfies uniform bounds if and only if the other does. Since  $\Omega_{\tau_\nu} = d\alpha$ , we can write

$$E_\nu(u_\nu) = \sup_{\varphi \in \mathcal{T}} \int_{\dot{S}_\nu} u_\nu^* d(\varphi(r)\Lambda_{\tau_\nu} + \alpha)$$

and thus conclude from Stokes' theorem and the bound on the periods at the positive ends (cf. Prop. 2.4) that  $E_\nu(u_\nu)$  is uniformly bounded.

The second issue is a larger danger. In order to bound the genus of  $\dot{S}_\nu$ , we use the following argument, originally suggested by Michael Hutchings and used already in [Wen13]. Since  $E_\nu(u_\nu)$  is bounded and we have convergence of the data  $\mathcal{H}_{\tau_\nu} \rightarrow \mathcal{H}_0$  and  $J_\nu \rightarrow J_0$ , a compactness theorem of Taubes [Tau98, Prop. 3.3] (see also [Hut02, Lemma 9.9]) implies that the sequence of currents represented by  $u_\nu$  has a convergent subsequence. This implies in particular that the relative homology classes of  $u_\nu$  have a convergent subsequence, so taking advantage of the assumption that  $u_\nu$  is somewhere injective, we can write down the adjunction inequality (2.10),

$$u_\nu * u_\nu \geq 2[\delta(u_\nu) + \delta_\infty(u_\nu)] + c_N(u_\nu) \geq c_N(u_\nu)$$

and observe that the left hand side is bounded. Now plugging in the definition of the normal Chern number from [Wen10a], we have

$$c_N(u_\nu) = c_1(u^*\Xi_{\tau_\nu}) - \chi(\dot{S}_\nu) + C$$

where the constant  $C \in \mathbb{Z}$  depends only on the extremal winding numbers at the asymptotic orbits and is thus fixed, and  $c_1(u^*\Xi_{\tau_\nu})$  is the relative first Chern number of the bundle  $u^*\Xi_{\tau_\nu} \rightarrow \dot{S}_\nu$  with respect to the  $S^1$ -invariant trivializations at the asymptotic orbits. The latter also depends only on the relative homology class of  $u_\nu$ , so we conclude that  $\chi(\dot{S}_\nu)$  is bounded from below, giving a bound on the genus of  $\dot{S}_\nu$  from above. Passing again to a subsequence, we may now assume all the surfaces  $\dot{S}_\nu$  are diffeomorphic.

To conclude, we observe that the dynamics of  $R_0$  are indeed nondegenerate up to period  $T_1$ . By Prop. 2.4 and the period bound imposed on the positive asymptotic orbits of  $u_\nu$ , every orbit that can appear in bubbling or breaking is therefore nondegenerate, in which case the proof of the main compactness theorem in [BEH<sup>+</sup>03] goes through and gives a subsequence convergent in the usual sense to a  $J_0$ -holomorphic building  $u_\infty$ .

The fact that all components of  $u_\infty$  are covers of interior leaves in  $\mathcal{F}$  follows now from Lemma 4.17.

*Step 2: Intersection theory.* The goal of this step is to show that  $u_\nu * u_\nu = 0$  for all  $\nu$  sufficiently large. Since  $H$  has no Morse critical points of Morse index 0, every curve in

$\mathcal{M}_2^{\mathcal{F}}(J_\nu)$  has all its ends at critical points of Morse index 2, thus they are all positive. Then Lemma 4.16 implies that for any  $v \in \mathcal{M}_2^{\mathcal{F}}(J_\nu)$ ,

$$(4.7) \quad u_\nu * v = 0.$$

We claim next that no negative end of  $u_\nu$  approaches any orbit of the form  $\gamma_z^k$  with  $\text{Morse}(z) = 2$ , and any positive end that approaches such an orbit has asymptotic winding zero. Here we use the assumption that every connected component of  $M_\Sigma$  intersects the planar piece  $M_P^{\text{plan}}$  and has a unique index 2 critical point: it follows via Proposition 4.10 that whenever  $\text{Morse}(z) = 2$ , for sufficiently large  $\nu$  there exists a curve  $v \in \mathcal{M}_2^{\mathcal{F}}(J_\nu)$  whose asymptotic orbits include  $\gamma_z$ . By Lemma 4.13,  $v$  approaches  $\gamma_z$  with zero asymptotic winding, so if the asymptotic winding of  $u_\nu$  approaching  $\gamma_z^k$  is nonzero, then the projections of  $u_\nu$  and  $v$  to  $M'$  intersect, implying  $u_\nu * v > 0$  and thus contradicting (4.7). Moreover, the end approaching  $\gamma_z^k$  cannot be negative, as its asymptotic winding would then be bounded from below by  $\alpha_+(\gamma^k)$ , which is 1 by Lemma 4.12.

Finally, we claim that for every orbit  $\gamma$  which occurs as an asymptotic orbit of  $u_\nu$ ,

$$(4.8) \quad u_\nu * (\mathbb{R} \times \gamma) = 0.$$

The orbit  $\gamma$  is necessarily of the form  $\gamma_z^k$  for  $z \in \text{Crit}_M(H)$  and  $k \in \mathbb{N}$  and has period less than  $T_1$ . If  $\text{Morse}(z) = 2$  then we may again assume due to Proposition 4.10 that  $\gamma_z$  is an asymptotic orbit for some  $v \in \mathcal{M}_2^{\mathcal{F}}(J_\nu)$ . Then any intersection of  $u_\nu$  with  $\mathbb{R} \times \gamma_z$  is necessarily positive and thus causes an intersection of  $u_\nu$  with an end of  $v$  approaching  $\gamma_z$ , again contradicting (4.7). Asymptotic contributions to  $u_\nu * (\mathbb{R} \times \gamma_z^k)$  are also ruled out since, as was just shown, any end of  $u_\nu$  approaching a cover of  $\gamma_z$  has asymptotic winding zero, and this matches  $\alpha_-(\gamma_z^k)$  by Lemma 4.12.

For the case  $\text{Morse}(z) = 1$  we argue slightly differently: we pass to the limit and show that  $u_\infty * (\mathbb{R} \times \gamma_z^k) = 0$ , which implies (4.8) for sufficiently large  $\nu$ . Recall that every connected component  $w$  of the building  $u_\infty$  is a cover of some leaf of  $\mathcal{F}$ . If this leaf is a trivial cylinder, then  $w * (\mathbb{R} \times \gamma_z^k) = 0$  by Lemma 2.11 since  $\mu_{\text{CZ}}(\gamma_z)$  is even. If it is not a trivial cylinder, then we instead obtain the same result from Lemma 4.14. There are also no breaking contributions to  $u_\infty * (\mathbb{R} \times \gamma_z^k)$  since there are no common breaking orbits with odd Conley-Zehnder index.

We have now established all the conditions to apply Lemma 2.10 and conclude

$$u_\nu * u_\nu = 0.$$

*Step 3: Nicely embedded curves degenerate nicely.* By the main result of [Wen10a], the limit building  $u_\infty$  must also be nicely embedded, in the sense that all of its levels are unions of trivial cylinders with nicely embedded curves: in particular, this means every component of  $u_\infty$  is an interior leaf of  $\mathcal{F}$ . By inspection of  $\mathcal{F}$ , the only connected multi-level buildings one can construct out of leaves have exactly two levels: the top consists of a disjoint union of trivial cylinders with gradient flow cylinders, and the bottom is a single holomorphic page. Any such building is a limit of a sequence of holomorphic pages in  $\mathcal{F}$ , and thus belongs to  $\overline{\mathcal{M}}^{\mathcal{F}}(J_0)$ , so we conclude that  $u_\nu \in \mathcal{M}^{\mathcal{F}}(J_\nu)$  for sufficiently large  $\nu$ .  $\square$

*Remark 4.21.* Proposition 4.20 also holds for any sufficiently small perturbations  $\Lambda'_\nu$  of  $\Lambda_{\tau_\nu}$  (fixed in a neighborhood of  $\text{Crit}_M(H) \times S^1$ ) and  $J'_\nu \in \mathcal{J}(d\Lambda'_\nu, \Lambda'_\nu)$  of  $J_\nu$ . In particular we can arrange in this way for  $\Lambda'_\nu$  to be a sequence of nondegenerate contact forms. The uniqueness result is proved by repeating the above argument for sequences  $\Lambda'_\nu \rightarrow \Lambda_{\tau_\nu}$  and  $J'_\nu \in \mathcal{J}(d\Lambda'_\nu, \Lambda'_\nu)$ ,  $J'_\nu \rightarrow J_\nu$  as  $\nu \rightarrow \infty$ . The only reason we did not state Prop. 4.20 to allow

this perturbation in the first place is that there is no obvious way to perturb the stable Hamiltonian structure  $\mathcal{H}_{\tau_\nu}$  together with  $\Lambda_{\tau_\nu}$ —instead, the compactness argument in the proof as  $\Lambda_{\tau_\nu}^\mu \rightarrow \Lambda_{\tau_\nu}$  requires the usual notion of energy for almost complex structures compatible with contact forms as in [Hof93], taking advantage of Proposition 2.1.

## 5. COMPUTATIONS IN ECH AND SFT

We now apply the holomorphic curve construction of the previous section to prove Theorems 1.17, 1.18 and 1.19.

Adopting the notation of §4, assume  $M$  is a compact 3-manifold contained in a closed and connected contact 3-manifold  $(M', \xi)$ ,  $\Omega$  is a closed 2-form on  $M'$  and  $\xi|_M$  is supported by an  $\Omega$ -separating partially planar spinal open book  $\pi$ . Fix all data necessary for defining the exact stable Hamiltonian structures  $\mathcal{H}_\tau = (d\alpha, \Lambda_\tau)$ , along with  $J_0 \in \mathcal{J}(\mathcal{H}_0)$  admitting the  $J_0$ -holomorphic finite energy foliation  $\mathcal{F}$  on  $\mathbb{R} \times M$  and the perturbed moduli spaces defined in §4.3 and §4.5. After possibly shrinking  $M$  to a smaller domain, we can and shall take Assumptions 4.19 as given. The assumptions also imply that  $\Omega$  is exact on  $M_\Sigma$ .

Denote the connected components of  $\Sigma$  by

$$\Sigma = \Sigma_1 \cup \dots \cup \Sigma_r$$

and for each  $i = 1, \dots, r$ , let  $z_i \in \text{Crit}_M(H)$  denote the unique index 2 critical point in  $\Sigma_i$ . Suppose the pages in  $M_P^{\text{pln}} \subset M_P$  have  $k + 1 \geq 1$  boundary components. Without loss of generality, we may assume that  $k$  is *minimal* in the sense that for any other connected component  $M_P^{\text{oth}} \subset M_P$  with planar pages and  $\partial M_P^{\text{oth}} \subset M_\Sigma$ , the pages have *at least*  $k + 1$  boundary components. For  $j = 1, \dots, r$ , let

$$m_j \in \mathbb{N}$$

denote the number of boundary components of each page in  $M_P^{\text{pln}}$  that lie in  $\Sigma_j \times S^1 \subset M_\Sigma$ .

For Theorems 1.18 and 1.17, we add the assumption that  $M$  is a planar  $k$ -torsion domain. In this case there is at least one other connected component  $M_P^{\text{oth}}$  which is “different” from  $M_P^{\text{pln}}$  in the sense that at least one of the following conditions holds:

- (1) The pages in  $M_P^{\text{oth}}$  are not diffeomorphic to those in  $M_P^{\text{pln}}$ ,
- (2) For some  $j \in \{1, \dots, r\}$ , the pages of  $M_P^{\text{oth}}$  do not have exactly  $m_j$  boundary components contained in  $\Sigma_j \times S^1$ .

These assumptions imply that at least one connected component of  $\Sigma$  has disconnected boundary, so after reordering the labels, assume this is true of  $\Sigma_r$ . We may then assume  $\Sigma_r$  contains at least one extra critical point

$$\zeta \in \Sigma_r, \quad \text{Morse}(\zeta) = 1,$$

such that the two gradient flow lines ending at  $\zeta$  enter through different components of  $\partial\Sigma_r$ , one from  $M_P^{\text{pln}}$  and the other from  $M_P^{\text{oth}}$ .

Choose a nondegenerate contact form  $\Lambda'_\nu$  and almost complex structure  $J'_\nu \in \mathcal{J}(\Lambda'_\nu)$  for which Propositions 4.10 and 4.20 both hold (see also Remark 4.21), and assume additionally that  $J'_\nu$  is generic, so  $\mathcal{M}_i^{\mathcal{F}}(J'_\nu)$  is empty for all  $i \leq 0$ . For any set of integers  $n_1, \dots, n_r \geq 0$ , define

$$(5.1) \quad \begin{aligned} \mathcal{M}(J'_\nu; H; n_1, \dots, n_r) &\subset \mathcal{M}(J'_\nu; H, T_1), \\ \overline{\mathcal{M}}(J'_\nu; H; n_1, \dots, n_r) &\subset \overline{\mathcal{M}}(J'_\nu; H, T_1), \end{aligned}$$

to consist of all connected curves or buildings respectively such that for each  $i \in \{1, \dots, r\}$ , the sum of the covering multiplicities of all positive asymptotic orbits in  $\Sigma_i \times S^1$  is less than or equal to  $n_i$ . Applying Propositions 4.10 and 4.20 under the above assumptions, we can now completely classify the somewhere injective curves in  $\mathcal{M}(J'_\nu; H; m_1, \dots, m_r)$  as follows. The generic curve in this space is an embedded index 2 punctured sphere with no negative ends and  $k + 1$  positive ends, of which  $m_j$  ends are asymptotic to  $\gamma_{z_j}$  for  $j = 1, \dots, r$ . Aside from trivial cylinders, the only other somewhere injective curves in  $\mathcal{M}(J'_\nu; H; m_1, \dots, m_r)$  are the following: for every  $i = 1, \dots, r$  and every index 1 critical point  $y \in \Sigma_i$ ,

- Each gradient flow line  $\ell$  entering through  $\partial\Sigma_i$  from  $M_P^{\text{pln}}$  and ending at  $y$  corresponds to a unique index 1 punctured sphere  $u_\ell$  with no negative ends, and  $k + 1$  positive ends asymptotic to the same collection of simply covered orbits as the generic curves, except with one copy of  $\gamma_{z_i}$  replaced by  $\gamma_y$ ;
- There are exactly two embedded index 1 cylinders  $v_y^+, v_y^-$ , each with a positive end at  $\gamma_{z_i}$  and negative end at  $\gamma_y$ , such that the closed cycle  $[v_y^+] - [v_y^-] \in H_2(M')$  defined by the two relative homology classes satisfies

$$\int_{[v_y^+] - [v_y^-]} \Omega = 0.$$

All of these curves are ECH-admissible, i.e. they satisfy  $\text{ind}(u) = I(u)$ .

*Proof of Theorem 1.18.* Consider the orbit set

$$\gamma = \{(\gamma_{z_1}, m_1), \dots, (\gamma_{z_{r-1}}, m_{r-1}), (\gamma_{z_r}, m_r - 1), (\gamma_\zeta, 1)\}$$

as a generator of the ECH chain complex for  $(M', \Lambda'_\nu, J'_\nu)$  with coefficients in  $\mathbb{Z}[H_2(M')/\ker \Omega]$ . Here we are abusing notation slightly by allowing the possibility  $m_r - 1 = 0$ ; if this is the case then  $\gamma_{z_r}$  should be removed from the orbit set altogether. By the above classification,  $\partial_{\text{ECH}}\gamma$  counts two index 1 cylinders  $v_y^+$  and  $v_y^-$  for every  $y \in \text{Crit}_M(H)$  with Morse index 1, but these are homologous in  $H_2(M')/\ker \Omega$ , and Proposition 2.14 implies that for any choice of coherent orientations provided by [BM04], they cancel each other out. Thus the only index 1 curve remaining to count is the punctured sphere  $u_\ell$  corresponding to the unique gradient flow line  $\ell$  that enters  $\partial\Sigma_r$  from  $M_P^{\text{pln}}$  and ends at  $\zeta$ . Since  $u_\ell$  has no positive ends, we find  $\partial_{\text{ECH}}\gamma = \emptyset$ .  $\square$

*Remark 5.1.* In the above proof, we achieved cancelation for the cylinders  $v_y^+$  and  $v_y^-$  by appealing to Proposition 2.14, which is a distinctly low-dimensional result, but there are also other ways to see that the paired cylinders in this particular setting must be oppositely oriented. One such approach is to cap off  $\Sigma$  by disks and extend the function  $H$  with a single index 0 critical point on each cap, and then identify the normal Cauchy-Riemann operators for the gradient flow cylinders with linearizations of the Floer equation with respect to a  $C^2$ -small time-independent Hamiltonian on the resulting closed surface. The computation of Hamiltonian Floer homology on this surface then implies that paired cylinders must cancel because the index 2 critical point (viewed as a constant Hamiltonian orbit) is a closed generator of the Floer chain complex. This approach can also work in higher-dimensional settings, cf. [Mora].

To complete the analogous computation in SFT, we must be a bit more careful since SFT in principle counts *all* holomorphic curves, not only those which are somewhere injective. To

be fully correct, the computation of SFT requires an abstract perturbation of the Cauchy-Riemann equation to achieve transversality for all solutions, e.g. this can be done following the polyfold scheme under development by Hofer-Wysocki-Zehnder, cf. [Hof]. We will not need to know any details about this perturbation, but only the following general principles:

- Any Fredholm regular holomorphic curve with index 1 gives rise uniquely to a solution of the perturbed problem for sufficiently small perturbations.
- If solutions of the perturbed problem with given asymptotic behavior exist for arbitrarily small perturbations, then as the perturbation is switched off we find a subsequence convergent to a holomorphic building with the same asymptotic behavior.

This understood, counting the solutions of the perturbed problem requires a precise description of the corresponding space of index 1  $J'_\nu$ -holomorphic buildings.

**Proposition 5.2.** *Suppose  $u \in \overline{\mathcal{M}}(J'_\nu; H; m_1, \dots, m_r)$  has index 1 and only simply covered orbits at its positive ends, including at most one such end asymptotic to  $\gamma_\zeta$  and the others all asymptotic to  $\gamma_{z_i}$  for  $i \in \{1, \dots, r\}$ . Then  $u$  has only one level and no nodes, and is somewhere injective: in particular, it is one of the curves  $u_\ell$  or  $v_y^\pm$  that were counted in the proof of Theorem 1.18.*

*Proof.* We observe first that  $u$  must have at least one connected component that is not a cover of a trivial cylinder: were it otherwise, then since every positive asymptotic orbit is simply covered and at most one of these is at an index 1 critical point, every component would be either a trivial cylinder or a branched cover of  $\mathbb{R} \times \gamma_z$  for  $\text{Morse}(z) = 2$ . Since the relevant covers of  $\gamma_z$  all have odd Conley-Zehnder index by Lemma 4.5, this would imply that  $\text{ind}(u)$  is even and thus gives a contradiction.

Next, observe that every nonconstant component of the top level belongs to the moduli space  $\mathcal{M}(J'_\nu; H; m_1, \dots, m_r)$  and is thus a curve in one of the perturbed moduli spaces arising from the foliation via Proposition 4.10. By induction, it follows that the nonconstant components of all other levels are also covers of such curves, so by Lemma 4.9, they all have nonnegative index. Since  $\text{ind}(u) = 1$ , Proposition 2.6 now implies that  $u$  cannot have any nodes and therefore (by stability) also has no constant components.

By assumption, the total multiplicities of the positive ends of  $u$  in each spinal component are bounded above by those of the holomorphic pages, thus at most one component of  $u$  can be a (perturbed) holomorphic page, and multiple covers of such curves cannot appear. If  $u$  does have a component that is a page, that component must be  $u_\ell$ , it must occupy the bottommost level, and all other components then must have index 0, implying via Lemma 4.9 that all other nontrivial components are branched covers of trivial cylinders with one positive end. A nontrivial cover of this type cannot appear in the top level since the positive asymptotic orbits are simply covered; by induction, it follows that such covers cannot appear anywhere, and we are left with  $u = u_\ell$ .

If no component of  $u$  is a perturbed page, then exactly one component is a cover of a (perturbed) gradient flow cylinder, which by Lemma 4.9 is then the unique component with index 1, while all others have index 0. Now the same argument again rules out any nontrivial index 0 components since the positive asymptotic orbits are simply covered, and implies at the same time that the index 1 component is somewhere injective, hence  $u = v_y^\pm$ .  $\square$

We briefly recall from [LW11] the necessary notation for the version of the SFT chain complex that is involved in the definition of algebraic torsion. A closed Reeb orbit for  $\Lambda'_\nu$  is called **good** if it is not a double cover of an orbit whose odd/even parity (defined in

terms of the Conley-Zehnder index) is different from its own. Let  $\mathcal{A}$  denote the  $\mathbb{Z}_2$ -graded supercommutative algebra with unit over the group ring  $\mathbb{R}[H_2(M')/\ker \Omega]$ , generated by all formal variables of the form  $q_\gamma$  where  $\gamma$  is a good orbit. Writing  $\dim M' = 2n - 1$ , the degree  $|q_\gamma| \in \mathbb{Z}_2$  of a generator is defined in general to be  $n - 3 + \mu_{\text{CZ}}(\gamma) \pmod{2}$ , thus in the present case,  $n = 2$  and the odd/even degree of  $q_\gamma$  is opposite the parity of  $\gamma$  as defined by the Conley-Zehnder index. The actual chain complex is the algebra of formal power series  $\mathcal{A}[[\hbar]]$ , where  $\hbar$  is a formal variable defined to have even degree. Counting index 1 solutions to a small abstract perturbation of the  $J'_\nu$ -holomorphic curve equation in the symplectization then gives rise to a differential operator  $D_{\text{SFT}} : \mathcal{A}[[\hbar]] \rightarrow \mathcal{A}[[\hbar]]$  satisfying  $(D_{\text{SFT}})^2 = 0$ , and the contact manifold  $(M, \ker \Lambda'_\nu)$  is said to have  $\Omega$ -twisted algebraic  $k$ -torsion for an integer  $k \geq 0$  if and only if  $\hbar^k$  is an exact element in the chain complex  $(\mathcal{A}[[\hbar]], D_{\text{SFT}})$ .

*Proof of Theorem 1.17.* We compute the operation of  $D_{\text{SFT}}$  on the element

$$Q := q_{\gamma_{z_1}}^{m_1} \dots q_{\gamma_{z_{r-1}}}^{m_{r-1}} q_{\gamma_{z_r}}^{m_r-1} q_\zeta \in \mathcal{A}$$

in the chain complex  $(\mathcal{A}[[\hbar]], D_{\text{SFT}})$  outlined above. By Proposition 5.2, all relevant index 1 solutions of the perturbed equation can be identified with the Fredholm regular  $J'_\nu$ -holomorphic curves  $u_\ell, v_y^\pm$  that were counted in the proof of Theorem 1.18. Once again the coherent orientations give  $v_y^+$  and  $v_y^-$  opposite signs due to Prop. 2.14 or Remark 5.1, so these cancel, and what's left is a single curve  $u_\ell$  with genus zero,  $k + 1$  positive punctures (one for each generator in  $Q$ ), and no negative punctures. This is exactly the same situation that arose in the more specialized computations of [LW11, Wen13], and for the same reasons, it gives  $D_{\text{SFT}}Q = \hbar^k$ .  $\square$

*Proof of Theorem 1.19.* Since the theorem is trivial whenever the ECH contact invariant vanishes, the case with planar torsion is implied by Theorem 1.18. Assume therefore that  $M \subset M'$  is not a planar torsion domain: in this case  $M = M'$ , there is no boundary, and all pages are planar and diffeomorphic to each other. Given  $d \in \mathbb{N}$ , we can without loss of generality arrange  $T_0 > 0$  in Lemma 4.5 sufficiently small so that

$$(k + 1)d < T_1/T_0.$$

Now by Proposition 4.11 (see also Remark 4.21), we can pick a nondegenerate contact form  $\Lambda'_\nu$  and generic  $J'_\nu \in \mathcal{J}(\Lambda'_\nu)$  so that for a generic point  $x \in M \setminus (\text{Crit}_M(H) \times S^1)$ ,  $(0, x) \in \mathbb{R} \times M$  is in the image of a unique index 2  $J'_\nu$ -holomorphic curve

$$u_x \in \mathcal{M}_2^{\mathcal{F}}(J'_\nu),$$

and by Prop. 4.20  $u_x$  is the only such curve in  $\mathcal{M}^*(J'_\nu; H, T_1)$ . We consider for  $n = 1, \dots, d$  the generator

$$\gamma_n = \{(\gamma_{z_1}, nm_1), \dots, (\gamma_{z_r}, nm_r)\}$$

in the ECH chain complex for  $\Lambda'_\nu, J'_\nu$  with coefficients in  $\mathbb{Z}[H_2(M)/\ker \Omega]$ . Then  $\partial_{\text{ECH}}\gamma_n$  counts only the pairs of cylinders  $v_y^+$  and  $v_y^-$  (combined with trivial cylinders) which cancel each other out due to Prop. 2.14 or Remark 5.1, thus

$$\partial_{\text{ECH}}\gamma_n = 0,$$

so  $\gamma_n$  represents a homology class in ECH. Defining the  $U$ -map by counting admissible index 2 curves through  $(0, x)$ , the action of  $U$  on  $\gamma_n$  then counts unions of trivial cylinders with the curve  $u_x$  and nothing else, hence

$$U\gamma_n = \gamma_{n-1},$$



implying  $U^d \gamma_d = \emptyset$ . Since one can choose the data to make this true for arbitrarily large  $d$ , the result follows.  $\square$

## 6. SPINAL OPEN BOOKS $\Rightarrow$ LEFSCHETZ FIBRATIONS

In this section we complete the proofs of Theorems 1.5, 1.10 and 1.13. By the non-fillability results proved in [LVW] via spine removal, we can restrict our attention to partially planar spinal open books that do not have planar torsion, i.e. from now on,  $M = M'$  has no boundary and  $\pi$  is symmetric. The main idea in the proofs will be to attach to a given filling  $(W, \omega)$  the special cylindrical end constructed in §3, which contains a pseudoholomorphic foliation, and then push this foliation into the filling  $W$ . The goal will be to obtain a Lefschetz fibration whose fibres are the leaves of the foliation and whose base is the moduli space itself. By looking at intersections of the leaves with each holomorphic vertebra, we will then show that the moduli space defines a branched cover of each vertebra, which will necessarily be unbranched if the spinal open book is Lefschetz-amenable (see Definition 1.4). Then, in order to complete the proof of Theorem 1.5, it will be necessary to understand how the moduli space deforms under a generic homotopy of almost complex structures associated to a homotopy of the symplectic data on  $W$ .

The argument is similar to the one in [Wen10c], and should be thought of as a punctured version of McDuff's classification of ruled symplectic manifolds [McD90]. There are two new ingredients in the spinal setting, however. The first and main new ingredient is that the moduli space of index 2 curves coming from the planar pages of the open book has codimension 1 boundary in addition to codimension 2 nodal curves. As in [Wen10c], the codimension 2 nodal curves correspond to Lefschetz critical fibers (a proof of this fact is sketched in the appendix of [Wen18]). The codimension 1 boundary consists of index 1 buildings in the filling attached to holomorphic gradient flow cylinders in  $\mathbb{R} \times M$ ; this phenomenon arises due to the presence of index 1 critical points on vertebrae, thus it can be avoided in the setting of ordinary open books (where all vertebrae are disks) but not in the general case. The key observation however is that these buildings come in canceling pairs, since the same can be assumed to be true for the gradient flow cylinders. The base of the Lefschetz fibration will thus be a quotient moduli space, obtained by "sewing together" the moduli space of index 2 curves along canceling boundary components. (We note that the actual situation is slightly more delicate since there may also be corner points to the moduli space, at which two boundary strata intersect.)

The second new ingredient compared with [Wen10c] is that in the spinal open book setting, it makes sense to consider *weak* fillings that are exact only on the spine. For a general weak filling, it is not possible to attach a symplectization end with a holomorphic foliation, but non-exactness away from the spine was already incorporated into the stable Hamiltonian model constructed in §3; we will take advantage of this by working directly with stable Hamiltonian data instead of contact data at infinity. In the more specialized setting of blown up summed open books, weak fillings were handled via a different and less powerful approach in [NW11].

**6.1. The completed filling and the moduli space.** Our standing assumptions will be as follows. Assume  $(M, \xi)$  is a *closed* contact 3-manifold with a supporting symmetric spinal open book

$$\pi := \left( \pi_\Sigma : M_\Sigma \rightarrow \Sigma, \pi_P : M_P \rightarrow S^1 \right)$$

whose pages have genus zero. As in §5, denote the connected components of  $\Sigma$  by

$$\Sigma_1, \dots, \Sigma_r \subset \Sigma,$$

and let

$$m_i \in \mathbb{N}, \quad i = 1, \dots, r$$

denote the number of boundary components that pages have in the component  $\Sigma_i \times S^1 \subset M_\Sigma$ ; note that this definition does not depend on the choice of a page since  $\pi$  is symmetric. Assume  $\Omega$  is a closed 2-form on  $M$  such that  $\Omega|_\xi > 0$  and  $\Omega|_{M_\Sigma}$  is exact, and  $(W, \omega)$  is a compact symplectic manifold with boundary  $\partial W = M$  such that  $\omega|_{TM} = \Omega$ . For the strong filling case of Theorem 1.5, we will sometimes also require  $\omega = d\lambda$  near  $\partial W$  for some 1-form  $\lambda$  such that

$$\alpha := \lambda|_{TM}$$

is a contact form for  $\xi$ . The dual Liouville vector field in this case will be denoted by  $V_\lambda$ , where by definition

$$\omega(V_\lambda, \cdot) = \lambda.$$

For the Liouville case,  $\lambda$  will be assumed to extend to a global primitive of  $\omega$  on  $W$ , and for the almost Stein case,  $\lambda$  will also have the form  $-df \circ J$  for some smooth function  $f : W \rightarrow \mathbb{R}$  and  $\omega$ -tame almost complex structure  $J$ .

In §3, we constructed a noncompact symplectic model  $(\widehat{E}, \omega_E)$  containing a weakly contact hypersurface

$$(M^-, \xi_-) \subset (\widehat{E}, \omega_E)$$

that is contactomorphic to  $(M, \xi)$ ; let us fix such a contactomorphism and identify  $M = M^-$  henceforward. The symplectic structure takes the form

$$\omega_E = \frac{1}{KC} (C d\lambda_K + \eta),$$

where  $\eta$  is a closed 2-form on  $M_P \subset M$  with  $[\eta] = [\Omega] \in H_{\text{dR}}^2(M)$ ,  $\lambda_K$  is a Liouville form whose restriction to  $M^-$  is a contact form for  $\xi_-$ , and  $C > 0$  and  $K > 0$  are large constants. Let

$$\widehat{\mathcal{N}}_-(\partial E) \subset \widehat{E}$$

denote the unbounded region in  $\widehat{E}$  with  $\partial \widehat{\mathcal{N}}_-(\partial E) = -M^-$ .

In general we only care about the deformation class of the symplectic data on  $W$ , thus we are free to make modifications in a collar neighborhood of  $\partial W$  and then rescale globally so as to produce any desired contact form  $\alpha$  at the boundary. By [MNW13, Lemma 2.10], we can deform  $\omega$  near  $\partial W$  and subsequently rescale so that without loss of generality,

$$\Omega = \omega_E|_{TM^-}$$

under the chosen contactomorphism identifying  $M$  with  $M^-$ . We then define a completion of  $(W, \omega)$  by

$$(\widehat{W}, \widehat{\omega}) := (W, \omega) \cup_{M=M^-} (\widehat{\mathcal{N}}_-(\partial E), \omega_E),$$

where a standard application of the Moser deformation trick (see for example [NW11, Lemma 2.3]) produces collars near  $\partial W$  and  $\partial \widehat{\mathcal{N}}_-(\partial E)$  that permit a smooth symplectic gluing of the two pieces. The gluing is simpler to describe if  $(W, \omega)$  is a strong or exact filling, as we can then use collar neighborhoods constructed by flowing along Liouville vector fields. In these cases we can assume  $\eta \equiv 0$  so that  $\omega_E$  is the exterior derivative of the Liouville form  $\frac{1}{K}\lambda_K$ , and  $\lambda$  can then (after a global rescaling) be deformed near  $\partial W$  so that it glues together smoothly

with  $\frac{1}{K}\lambda_K$ . Denote the resulting Liouville form on a neighborhood of  $\widehat{\mathcal{N}}_-(\partial E) \subset \widehat{W}$  by  $\widehat{\lambda}$ , so we have

$$\widehat{\omega} = d\widehat{\lambda}$$

on this neighborhood if  $(W, \omega)$  is a strong filling, and the same holds globally on  $\widehat{W}$  if the filling is exact.

We must do something slightly different in the almost Stein case: recall from §3.7 that  $(\widehat{E}, \omega_E)$  comes equipped with a compatible almost complex structure  $J_+$  and a  $J_+$ -convex function  $f_+ : \widehat{E} \rightarrow \mathbb{R}$  such that the induced Liouville form  $\lambda_+ = -df_+ \circ J_+$  matches  $\frac{1}{K}\lambda_K$  on the region  $\widehat{\mathcal{N}}(\partial_h E) \subset \widehat{E}$  but not everywhere else. We shall therefore forget temporarily about  $\omega_E$  and glue the almost Stein manifolds  $(W, J, f)$  and  $(\widehat{\mathcal{N}}_-(\partial E), J_+, f_+)$  together along  $M = M^-$ . To enable this, one can first deform the Weinstein structures  $(\omega, V_\lambda, f)$  near  $\partial W$  and rescale  $\lambda$  and  $f$  globally so that these data glue together smoothly with  $\lambda_+$  and  $f_+$ ; this can be done without introducing any critical points of  $f$  in the collar, thus one can then apply Lemma 3.10 to produce a deformed  $d\lambda$ -tame almost complex structure  $J$  with  $\lambda = -df \circ J$  such that  $J$  glues together smoothly with  $J_+$ . The result is an almost Stein completion

$$(\widehat{W}, \widehat{J}, \widehat{f}) = (W, J, f) \cup_{M=M^-} (\widehat{\mathcal{N}}_-(\partial E), J_+, f_+)$$

such that  $\widehat{\lambda} := -d\widehat{f} \circ \widehat{J}$  matches the modified Liouville form  $\lambda_+$  in the cylindrical end. By gluing  $\lambda$  together with the interpolated Liouville form  $\Theta$  provided by Lemma 3.11, we also obtain a Liouville form  $\widehat{\Theta}$  on  $\widehat{W}$  with

- $\widehat{\Theta} = \widehat{\lambda}$  on  $W$ ,
- $\widehat{\Theta} = \frac{1}{K}\lambda_K$  near infinity, and
- $d\widehat{\Theta}$  tames  $\widehat{J}$  everywhere.

We will use  $\widehat{\Theta}$  below to define energy for  $\widehat{J}$ -holomorphic curves in  $\widehat{W}$ .

Recall now that the end we just attached to form the completion contains a region

$$\widehat{\mathcal{N}}_+(\partial E) \subset \widehat{\mathcal{N}}_-(\partial E)$$

that is identified with the half-symplectization  $[0, \infty) \times M^+$  of a certain stable hypersurface  $M^+ = -\partial\widehat{\mathcal{N}}_+(\partial E) \subset \widehat{E}$ , carrying a stable Hamiltonian structure  $\mathcal{H}_+ = (\Omega_+, \Lambda_+)$ . In §3.7 and §3.8, we constructed the compatible almost complex structure  $J_+$  such that its restriction to  $\widehat{\mathcal{N}}_+(\partial E)$  is in  $\mathcal{J}(\mathcal{H}_+)$ , and  $(\widehat{\mathcal{N}}_-(\partial E), J_+)$  contains *holomorphic vertebrae* and *holomorphic pages*. Indeed, let us select a holomorphic vertebra from Proposition 3.8 corresponding to each component  $\Sigma_i \subset \Sigma$ , and denote it by

$$\dot{\Sigma}_i \subset \widehat{\mathcal{N}}_-(\partial E) \subset \widehat{W}, \quad i = 1, \dots, r.$$

Meanwhile, the holomorphic pages form a foliation  $\mathcal{F}_+$  on  $\widehat{E}$  whose restriction to  $\widehat{\mathcal{N}}_+(\partial E) = [0, \infty) \times M^+$  has the same form as the foliation  $\mathcal{F}$  that we considered in §4, thus we are free to use the analytical results of that section, including the index and intersection-theoretic computations. We are also free to impose Assumptions 4.19—this mostly follows already from the premise that  $\pi$  is a partially planar domain without planar torsion, but it includes also the following conditions on the Hamiltonian function  $H : \Sigma \rightarrow [0, \infty)$  and complex structure  $j$  on  $\Sigma$  that play key roles in the construction of  $\mathcal{F}_+$ :

- $H : \Sigma \rightarrow [0, \infty)$  has no index 0 Morse critical points, and it has exactly one index 2 critical point on every connected component of  $\Sigma$ ;
- $(H, j)$  are in general position (see Definition 4.7).

For technical reasons, it will be convenient (though not essential) to add one more assumption:<sup>7</sup>

- The Hessian  $\nabla^2 H(z) : T_z \Sigma \rightarrow T_z \Sigma$  commutes with  $j$  at every  $z \in \text{Crit}_M(H)$  with  $\text{Morse}(z) = 2$ .

The assumptions on  $H$  imply that each index 1 critical point of  $H$  is connected to the unique index 2 critical point in the same connected component of  $\Sigma$  by exactly two gradient flow lines. The resulting gradient flow cylinders receive opposite orientations by Prop. 2.14 or Remark 5.1. It will be useful to note that the unbranched multiple covers of these cylinders also satisfy the automatic transversality criterion of Prop. 2.12 and have the same properties with regard to orientations, hence:

**Lemma 6.1.** *Every holomorphic gradient flow cylinder  $u$  in  $\mathcal{F}_+$  is a Fredholm regular index 1 curve, and so are its unbranched  $k$ -fold covers for every  $k \in \mathbb{N}$ . Moreover,  $\mathcal{F}_+$  contains exactly two holomorphic gradient flow cylinders asymptotic to the same pair of orbits, and for any choice of coherent orientations from [BM04] and for each  $k \in \mathbb{N}$ , the unbranched  $k$ -fold covers of these two gradient flow cylinders are oppositely oriented.  $\square$*

We will refer to the pairs of gradient flow cylinders described in this lemma as **canceling pairs**.

Assumptions 4.19 also presume that Lemma 4.5 is applicable, imposing dynamical conditions on the stable Hamiltonian structure  $\mathcal{H}_+$ : in particular, this provides constants  $T_0, T_1 > 0$  such that all Reeb orbits of period less than  $T_1$  are covers of  $\{z\} \times S^1 \subset \widetilde{M}_\Sigma^+$ , and each simply covered orbit of this form has period less than  $T_0$ , where  $T_1/T_0$  may be assumed arbitrarily large. More specifically,  $T_1/T_0$  is assumed to be larger than the number of boundary components of any page. Since  $\mathcal{H}_+$  is of confoliation type, Proposition 2.4 then implies that all breaking orbits appearing in the holomorphic buildings discussed below will be covers of  $\{z\} \times S^1$  for various  $z \in \text{Crit}_M(H)$ . These orbits are **elliptic** if  $\text{Morse}(z) = 2$  and **hyperbolic** if  $\text{Morse}(z) = 1$ , so we will refer to them as such.

In the almost Stein case, we have already extended  $J_+$  to a  $d\widehat{\Theta}$ -tame almost complex structure  $\widehat{J}$  on  $\widehat{W}$ , and we shall allow a generic  $d\widehat{\Theta}$ -tame perturbation of  $\widehat{J}$  in the interior of  $W$ ; note that this perturbs the Liouville form  $\widehat{\lambda} = -df \circ \widehat{J}$ , but such a change is harmless since the Liouville condition is open. In the weak, strong and exact cases, we simply extend  $J_+$  arbitrarily to an  $\widehat{\omega}$ -tame almost complex structure  $\widehat{J}$  on  $\widehat{W}$  which is generic in the interior of  $W$ . In particular,  $\widehat{J}$  satisfies

$$\widehat{J} \equiv J_+ \quad \text{in } \widehat{\mathcal{N}}_-(\partial E),$$

and this gives  $(\widehat{W}, \widehat{J})$  the structure of an almost complex manifold with a cylindrical end  $([0, \infty) \times M^+, J_+)$  compatible with the stable Hamiltonian structure  $\mathcal{H}_+ = (\Omega_+, \Lambda_+)$ . We define the **energy** of a punctured  $\widehat{J}$ -holomorphic curve  $u : \dot{S} \rightarrow \widehat{W}$  as

$$E(u) := \sup_{\varphi \in \mathcal{T}} \int_{\dot{S}} u^* \widehat{\omega}_\varphi,$$

---

<sup>7</sup>The purpose of this extra assumption is to simplify Lemma 6.9, which implies a special case of the unpublished folk theorem that asymptotic contributions to Siefring's intersection numbers (see §2.3) are a non-generic phenomenon for somewhere injective curves.

where for some  $T > 0$  chosen large enough such that  $\widehat{\Theta} = \frac{1}{K}\lambda_K$  in  $[T, \infty) \times M^+ \subset \widehat{\mathcal{N}}_+(\partial E)$ ,

$$\mathcal{T} := \left\{ \varphi \in C^\infty([T, \infty) \rightarrow [T, T+1)) \mid \varphi' > 0 \text{ and } \varphi(r) = r \text{ for } r \text{ near } T \right\},$$

and the modified symplectic form  $\widehat{\omega}_\varphi$  is defined such that

$$\widehat{\omega}_\varphi = d\left((e^{\varphi(r)} - 1)\Lambda_+\right) + \Omega_+ \quad \text{on } [T, \infty) \times M^+,$$

while on the rest of  $\widehat{W}$ ,  $\widehat{\omega}_\varphi$  is defined to match  $d\widehat{\Theta}$  in the almost Stein case or  $\widehat{\omega}$  in weak, strong and Liouville cases. The point of this definition is that curves with  $E(u) < \infty$  will now have asymptotically cylindrical behavior and obey the compactness theory in [BEH<sup>+</sup>03].

We will also need to consider smooth deformations

$$\omega_\tau, \quad \lambda_\tau, \quad J_\tau, \quad f_\tau \quad 0 \leq \tau \leq 1$$

of the symplectic data on  $W$ . After suitable modifications near  $\partial W$  and global rescaling, we can fit this into the above picture by considering a smooth 1-parameter family of completed fillings

$$(\widehat{W}, \widehat{\omega}_\tau) \text{ or } (\widehat{W}, \widehat{J}_\tau, \widehat{f}_\tau), \quad 0 \leq \tau \leq 1$$

with a generic 1-parameter family of tame almost complex structures  $\widehat{J}_\tau$  such that all the data on  $\widehat{\mathcal{N}}_-(\partial E) \subset \widehat{W}$  is  $\tau$ -independent and matches the construction above. The definition of energy is then also  $\tau$ -dependent, but this does not affect the existence of uniform energy bounds since the data is  $\tau$ -independent in the cylindrical end.

With this setting in place, our moduli spaces of curves in  $\widehat{W}$  will now be defined in terms of the  $J_+$ -holomorphic foliation  $\mathcal{F}_+$  of  $\mathbb{R} \times M^+$ . Let  $\mathcal{M}^{\mathcal{F}_+}(J_+)$  denote the moduli space of unparametrized  $J_+$ -holomorphic curves in  $\mathbb{R} \times M^+$  modulo  $\mathbb{R}$ -translation that belong to the foliation  $\mathcal{F}_+$ , and let

$$\mathcal{M}_i^{\mathcal{F}_+}(J_+) \subset \mathcal{M}^{\mathcal{F}_+}(J_+) \quad \text{for } i = 1, 2$$

denote the components with virtual dimension  $i$ . We denote by  $\overline{\mathcal{M}}^{\mathcal{F}_+}(J_+)$  and  $\overline{\mathcal{M}}_i^{\mathcal{F}_+}(J_+) \subset \overline{\mathcal{M}}^{\mathcal{F}_+}(J_+)$  respectively the closures of these in the space of stable holomorphic buildings in  $(\mathbb{R} \times M^+, J_+)$ , see §2.2. The structure of the foliation  $\mathcal{F}_+$  implies that  $\mathcal{M}_1^{\mathcal{F}_+}(J_+) = \overline{\mathcal{M}}_1^{\mathcal{F}_+}(J_+)$  is a finite set, consisting of all holomorphic gradient flow cylinders and the exceptional holomorphic pages that have one end asymptotic to a hyperbolic orbit and the rest asymptotic to elliptic orbits. Each connected component of  $\overline{\mathcal{M}}_2^{\mathcal{F}_+}(J_+)$  is either a circle or a compact interval bounded by buildings with two levels whose unique nontrivial components are each curves in  $\mathcal{M}_1^{\mathcal{F}_+}(J_+)$ . Define an equivalence relation by saying that for two buildings  $u$  and  $u'$ ,  $u \sim u'$  if and only if their positive asymptotic orbits coincide up to a permutation of the punctures and their bottommost levels are identical; we shall write

$$\widehat{\mathcal{M}}^{\mathcal{F}_+}(J_+) := \overline{\mathcal{M}}_2^{\mathcal{F}_+}(J_+)/\sim.$$

This quotient moduli space has the topology of a disjoint union of circles: indeed, Lemma 6.1 implies that the equivalence relation identifies pairs of buildings in  $\partial\overline{\mathcal{M}}_2^{\mathcal{F}_+}(J_+)$  having the same index 1 holomorphic page in their lower levels and a canceling pair of gradient flow cylinders in their upper levels. Note that gradient flow cylinders never appear as bottom levels of these buildings, thus the elements of  $\widehat{\mathcal{M}}^{\mathcal{F}_+}(J_+)$  have no negative ends.

Let  $\mathcal{M}(\hat{J})$  and  $\overline{\mathcal{M}}(\hat{J})$  denote the spaces of unparametrized finite-energy holomorphic curves or stable buildings respectively with arithmetic genus zero in  $(\widehat{W}, \hat{J})$ , and define a similar equivalence relation by

$$\widehat{\mathcal{M}}(\hat{J}) := \overline{\mathcal{M}}(\hat{J}) / \sim,$$

where  $u$  and  $u'$  are considered equivalent if and only if their asymptotic orbits coincide up to permutation and their bottommost nonempty levels are identical. Since the main level is allowed to be empty in general, it may happen that the bottommost nonempty level of  $u \in \overline{\mathcal{M}}(\hat{J})$  is an upper level, and viewing buildings in  $(\mathbb{R} \times M^+, J_+)$  without negative ends as buildings in  $(\widehat{W}, \hat{J})$  with empty main levels gives rise to a natural inclusion

$$(6.1) \quad \widehat{\mathcal{M}}^{\mathcal{F}^+}(J_+) \subset \widehat{\mathcal{M}}(\hat{J}).$$

With this inclusion in mind, we define

$$\widehat{\mathcal{M}}^{\mathcal{F}}(\hat{J}) \subset \widehat{\mathcal{M}}(\hat{J})$$

to be the smallest open and closed subset that contains  $\widehat{\mathcal{M}}^{\mathcal{F}^+}(J_+)$ . Observe that since the holomorphic pages in  $\mathcal{M}^{\mathcal{F}^+}(J_+)$  have only positive ends, they can also be regarded as  $\hat{J}$ -holomorphic curves in  $[0, \infty) \times M^+ = \hat{N}_+(\partial E) \subset \widehat{W}$ , so that each  $u \in \widehat{\mathcal{M}}^{\mathcal{F}^+}(J_+)$  gives rise to a 1-parameter family of elements in  $\widehat{\mathcal{M}}^{\mathcal{F}}(\hat{J})$  that converge in the SFT-topology to  $u$  as their main levels are pushed to infinity. All these families of holomorphic pages therefore belong to  $\widehat{\mathcal{M}}^{\mathcal{F}}(\hat{J})$ , and we will see in Proposition 6.3 below that they form collar neighborhoods of the boundary of  $\widehat{\mathcal{M}}^{\mathcal{F}}(\hat{J})$ .

Define subsets

$$\widehat{\mathcal{M}}_{\text{reg}}^{\mathcal{F}}(\hat{J}), \widehat{\mathcal{M}}_{\text{sing}}^{\mathcal{F}}(\hat{J}), \widehat{\mathcal{M}}_{\text{exot}}^{\mathcal{F}}(\hat{J}) \subset \widehat{\mathcal{M}}^{\mathcal{F}}(\hat{J}),$$

where:

- $u \in \widehat{\mathcal{M}}_{\text{reg}}^{\mathcal{F}}(\hat{J})$  if its main level is a smooth embedded  $\hat{J}$ -holomorphic curve with one connected component and only simply covered asymptotic orbits;
- $u \in \widehat{\mathcal{M}}_{\text{sing}}^{\mathcal{F}}(\hat{J})$  if its main level is a nodal  $\hat{J}$ -holomorphic curve with two embedded connected components that intersect each other transversely at a single node and nowhere else, and both have only simply covered asymptotic orbits;
- $u \in \widehat{\mathcal{M}}_{\text{exot}}^{\mathcal{F}}(\hat{J})$  if its main level is a smooth embedded  $\hat{J}$ -holomorphic curve with one connected component such that one of its asymptotic orbits is doubly covered, and the rest are simply covered.

As the notation should suggest, elements of  $\widehat{\mathcal{M}}_{\text{reg}}^{\mathcal{F}}(\hat{J})$  and  $\widehat{\mathcal{M}}_{\text{sing}}^{\mathcal{F}}(\hat{J})$  will give rise to the regular and singular fibers respectively of a Lefschetz fibration on  $W$  when the spinal open book is Lefschetz-amenable. Elements of  $\widehat{\mathcal{M}}_{\text{exot}}^{\mathcal{F}}(\hat{J})$  are a slightly different kind of object that we will refer to as **exotic fibers**: we will see that they can occur only in the non-amenable case, thus producing a topological decomposition of  $W$  that is more general than a Lefschetz fibration.

**Definition 6.2.** For  $i = 1, 2$ , assume  $\Sigma_i$  are closed oriented surfaces and  $\dot{\Sigma}_i \subset \Sigma_i$  are obtained by deleting finitely many points. A continuous map  $\pi : \dot{\Sigma}_1 \rightarrow \dot{\Sigma}_2$  will be called a **branched cover (with degree  $d \in \mathbb{N}$ ) of surfaces with cylindrical ends** if it is proper and its unique extension to a map  $\Sigma_1 \rightarrow \Sigma_2$  is a branched cover (with degree  $d$ ). We will say that

a branched cover  $\pi : \dot{\Sigma}_1 \rightarrow \dot{\Sigma}_2$  is **generic** if its branch points are all simple (i.e. they have branching order 2) and all have distinct images.<sup>8</sup>

**Proposition 6.3.** *For generic choices of  $\hat{J}$  on  $\widehat{W}$  satisfying the conditions specified above,  $\widehat{\mathcal{M}}^{\mathcal{F}}(\hat{J})$  decomposes into disjoint subsets*

$$\widehat{\mathcal{M}}^{\mathcal{F}}(\hat{J}) = \widehat{\mathcal{M}}_{\text{reg}}^{\mathcal{F}}(\hat{J}) \cup \widehat{\mathcal{M}}_{\text{sing}}^{\mathcal{F}}(\hat{J}) \cup \widehat{\mathcal{M}}_{\text{exot}}^{\mathcal{F}}(\hat{J}) \cup \widehat{\mathcal{M}}^{\mathcal{F}+}(J_+),$$

where  $\widehat{\mathcal{M}}_{\text{reg}}^{\mathcal{F}}(\hat{J})$  is an open subset,  $\widehat{\mathcal{M}}_{\text{sing}}^{\mathcal{F}}(\hat{J})$  and  $\widehat{\mathcal{M}}_{\text{exot}}^{\mathcal{F}}(\hat{J})$  are each finite, and  $\widehat{\mathcal{M}}^{\mathcal{F}}(\hat{J})$  has the topology of a compact, connected and oriented surface with boundary

$$\partial\widehat{\mathcal{M}}^{\mathcal{F}}(\hat{J}) = \widehat{\mathcal{M}}^{\mathcal{F}+}(J_+).$$

Moreover, every point in  $\widehat{W}$  is in the image of the main level for a unique curve in the interior of  $\widehat{\mathcal{M}}^{\mathcal{F}}(\hat{J})$ , and this interior admits a smooth structure such that the resulting continuous surjection

$$\Pi : \widehat{W} \rightarrow \widehat{\mathcal{M}}^{\mathcal{F}}(\hat{J}) \setminus \widehat{\mathcal{M}}^{\mathcal{F}+}(J_+) : x \mapsto \text{the curve through } x$$

is smooth outside the finitely many nodes of the curves in  $\widehat{\mathcal{M}}_{\text{sing}}^{\mathcal{F}}(\hat{J})$ . For each  $i = 1, \dots, r$ , the holomorphic vertebra  $\dot{\Sigma}_i \subset \widehat{W}$  is disjoint from the nodes of curves in  $\widehat{\mathcal{M}}_{\text{sing}}^{\mathcal{F}}(\hat{J})$ , and the map  $\Pi$  restricts to  $\dot{\Sigma}_i$  as a generic branched cover with degree  $m_i$  of surfaces with cylindrical ends, whose branch points all have image in  $\widehat{\mathcal{M}}_{\text{reg}}^{\mathcal{F}}(\hat{J})$ . Finally,  $\widehat{\mathcal{M}}_{\text{exot}}^{\mathcal{F}}(\hat{J})$  is empty if and only if the branched covers  $\Pi|_{\dot{\Sigma}_i}$  have no branch points for every  $i = 1, \dots, r$ .

This will be enough to conclude the first part of Theorem 1.5, that a planar spinal open book must be uniform if  $M$  is fillable, and we will explain in §6.5 how to turn  $\Pi : \widehat{W} \rightarrow \widehat{\mathcal{M}}^{\mathcal{F}}(\hat{J}) \setminus \partial\widehat{\mathcal{M}}^{\mathcal{F}}(\hat{J})$  into a bordered Lefschetz fibration on  $W$  whenever there are no exotic fibers.

We now state a corresponding result for 1-parameter deformations of the data. Consider a 1-parameter family of almost complex structures  $\{\hat{J}_\tau\}_{\tau \in [0,1]}$  on  $\widehat{W}$  such that

- $\hat{J}_\tau|_{\widehat{\mathcal{N}}_-(\partial E)} = J_+$  for all  $\tau$ ;
- $\hat{J}_\tau$  is  $\hat{\omega}_\tau$ -tame (or in the almost Stein case  $d\hat{\Theta}_\tau$ -tame) for all  $\tau$ ;
- $\hat{J}_0 = \hat{J}$ ;
- $\hat{J}_1$  and the homotopy  $\{\hat{J}_\tau\}$  are both generic on the interior of  $W$ .

Let  $\mathcal{M}(\{\hat{J}_\tau\})$ ,  $\overline{\mathcal{M}}(\{\hat{J}_\tau\})$  and  $\widehat{\mathcal{M}}(\{\hat{J}_\tau\})$  denote the spaces of pairs  $(u, \tau)$  with  $\tau \in [0, 1]$  and  $u \in \mathcal{M}(\hat{J}_\tau)$ ,  $u \in \overline{\mathcal{M}}(\hat{J}_\tau)$  or  $u \in \widehat{\mathcal{M}}(\hat{J}_\tau)$  respectively. Since  $\hat{J}_\tau$  is independent of  $\tau$  near infinity, the inclusion (6.1) generalizes to this parametrized setting as

$$\widehat{\mathcal{M}}^{\mathcal{F}+}(J_+) \times [0, 1] \subset \widehat{\mathcal{M}}(\{\hat{J}_\tau\}),$$

and we define

$$\widehat{\mathcal{M}}^{\mathcal{F}}(\{\hat{J}_\tau\}) \subset \widehat{\mathcal{M}}(\{\hat{J}_\tau\})$$

as the smallest open and closed subset containing  $\widehat{\mathcal{M}}^{\mathcal{F}+}(J_+) \times [0, 1]$ , along with subsets

$$\widehat{\mathcal{M}}_{\text{reg}}^{\mathcal{F}}(\{\hat{J}_\tau\}), \widehat{\mathcal{M}}_{\text{sing}}^{\mathcal{F}}(\{\hat{J}_\tau\}), \widehat{\mathcal{M}}_{\text{exot}}^{\mathcal{F}}(\{\hat{J}_\tau\}) \subset \widehat{\mathcal{M}}^{\mathcal{F}}(\{\hat{J}_\tau\})$$

<sup>8</sup>Note that the generic conditions imposed on branch points do not apply to all branch points of the *extended* map  $\Sigma_1 \rightarrow \Sigma_2$ , which can include punctures.

defined by the same criteria as before. For  $\tau \in [0, 1]$ , let

$$\widehat{\mathcal{M}}^{\mathcal{F}}(\widehat{J}_\tau) := \left\{ u \in \widehat{\mathcal{M}}(\widehat{J}_\tau) \mid (u, \tau) \in \widehat{\mathcal{M}}^{\mathcal{F}}(\{\widehat{J}_\tau\}) \right\},$$

with corresponding subsets  $\widehat{\mathcal{M}}_{\text{reg}}^{\mathcal{F}}(\widehat{J}_\tau)$ ,  $\widehat{\mathcal{M}}_{\text{sing}}^{\mathcal{F}}(\widehat{J}_\tau)$  and  $\widehat{\mathcal{M}}_{\text{exot}}^{\mathcal{F}}(\widehat{J}_\tau)$ . We will sometimes identify  $\widehat{\mathcal{M}}^{\mathcal{F}}(\widehat{J})$  and  $\widehat{\mathcal{M}}^{\mathcal{F}}(\widehat{J}_\tau)$  with the corresponding subsets of  $\widehat{\mathcal{M}}^{\mathcal{F}}(\{\widehat{J}_\tau\})$ .

**Proposition 6.4.** *For generic families  $\{\widehat{J}_\tau\}_{\tau \in [0,1]}$  satisfying the conditions specified above, there exists a homeomorphism*

$$\Psi : \widehat{\mathcal{M}}^{\mathcal{F}}(\widehat{J}) \times [0, 1] \rightarrow \widehat{\mathcal{M}}^{\mathcal{F}}(\{\widehat{J}_\tau\})$$

satisfying

$$\begin{aligned} \Psi(\widehat{\mathcal{M}}_{\text{reg}}^{\mathcal{F}}(\widehat{J}) \times [0, 1]) &= \widehat{\mathcal{M}}_{\text{reg}}^{\mathcal{F}}(\{\widehat{J}_\tau\}), \\ \Psi(\widehat{\mathcal{M}}_{\text{sing}}^{\mathcal{F}}(\widehat{J}) \times [0, 1]) &= \widehat{\mathcal{M}}_{\text{sing}}^{\mathcal{F}}(\{\widehat{J}_\tau\}), \\ \Psi(\widehat{\mathcal{M}}_{\text{exot}}^{\mathcal{F}}(\widehat{J}) \times [0, 1]) &= \widehat{\mathcal{M}}_{\text{exot}}^{\mathcal{F}}(\{\widehat{J}_\tau\}), \\ \Psi(\widehat{\mathcal{M}}^{\mathcal{F}}(\widehat{J}) \times \{\tau\}) &= \widehat{\mathcal{M}}^{\mathcal{F}}(\widehat{J}_\tau) \text{ for every } \tau \in [0, 1], \end{aligned}$$

and  $\Psi$  restricts to the identity map on the subsets  $\widehat{\mathcal{M}}^{\mathcal{F}+}(J_+) \times [0, 1]$  and  $\widehat{\mathcal{M}}^{\mathcal{F}}(\widehat{J}) \times \{0\}$  in  $\widehat{\mathcal{M}}^{\mathcal{F}}(\{\widehat{J}_\tau\})$ . Moreover, outside of  $\widehat{\mathcal{M}}^{\mathcal{F}+}(J_+) \times [0, 1]$ , one can define a natural smooth structure on  $\widehat{\mathcal{M}}^{\mathcal{F}}(\{\widehat{J}_\tau\})$  for which  $\Psi$  is smooth outside of possibly finitely many points in  $\widehat{\mathcal{M}}_{\text{sing}}^{\mathcal{F}}(\widehat{J}) \times (0, 1)$  and  $\widehat{\mathcal{M}}_{\text{exot}}^{\mathcal{F}}(\widehat{J}) \times (0, 1)$ , and the conclusions of Proposition 6.3 hold for  $\widehat{\mathcal{M}}^{\mathcal{F}}(\widehat{J}_\tau)$  for every  $\tau \in [0, 1]$ , giving a continuous surjection

$$\begin{aligned} \Pi : \widehat{W} \times [0, 1] &\rightarrow \widehat{\mathcal{M}}^{\mathcal{F}}(\{\widehat{J}_\tau\}) \setminus \left( \widehat{\mathcal{M}}^{\mathcal{F}+}(J_+) \times [0, 1] \right) \\ (x, \tau) &\mapsto (u, \tau) \text{ where } x \in \text{im}(u) \end{aligned}$$

which is smooth outside of the finite collection of continuous and piecewise smooth paths in  $\widehat{W} \times [0, 1]$  traced out by the nodes of curves in  $\widehat{\mathcal{M}}_{\text{sing}}^{\mathcal{F}}(\{\widehat{J}_\tau\})$ . The restriction of  $\Pi$  to  $\widehat{\Sigma}_i \times [0, 1]$  for  $i = 1, \dots, r$  defines a smooth deformation of generic branched covers of surfaces with cylindrical ends.

*Remark 6.5.* The caveat about the smoothness of  $\Psi$  in Proposition 6.4 has to do with isolated breaking configurations in  $\widehat{\mathcal{M}}_{\text{sing}}^{\mathcal{F}}(\{\widehat{J}_\tau\})$  and  $\widehat{\mathcal{M}}_{\text{exot}}^{\mathcal{F}}(\{\widehat{J}_\tau\})$  that will be dealt with in Lemma 6.30. Here there are always two ways to glue such configurations and thus move the parameter  $\tau$  forward or backward, producing a 1-parameter family that is manifestly continuous, but we have chosen not to worry about whether it is smooth. This is in any case immaterial in our main applications, for which the moduli space does not need to have a canonical smooth structure as long as the foliation it produces on  $\widehat{W}$  is smooth. (In places where the latter is in doubt, i.e. at nodal points, the foliation can always be smoothed by hand with a small perturbation.)

**6.2. Generic conditions.** Before stating the main compactness results, let us clarify the role that our genericity conditions on  $\widehat{J}$  and  $\{\widehat{J}_\tau\}$  are going to play. As usual such assumptions guarantee that moduli spaces of somewhere injective curves are smooth and have dimension equal to the index, with the consequence that this index is bounded from below. In addition to this, we will need to use genericity on occasion to limit non-transverse intersections and asymptotic intersection contributions in the sense of Siefring. The results of this subsection



should be understood to be true after choosing  $\widehat{J}$  and  $\{\widehat{J}_\tau\}$  from comeager subsets of the sets of all almost complex structures or smooth homotopies thereof with the properties specified in §6.1.

**Lemma 6.6.** *For every  $\tau \in [0, 1]$ , all somewhere injective  $\widehat{J}_\tau$ -holomorphic curves  $v$  in  $\widehat{W}$  that intersect the interior of  $W$  satisfy  $\text{ind}(v) \geq -1$ , and there exists at most one such curve (up to parametrization) with  $\text{ind}(v) = -1$ . Moreover, for almost every  $\tau \in [0, 1]$ , and in particular for  $\tau = 0$  and  $\tau = 1$ , all such curves satisfy  $\text{ind}(v) \geq 0$ .*

*Proof.* The almost complex structures  $\widehat{J}_\tau$  are fixed on  $\widehat{N}_-(\partial E) \subset \widehat{W}$  but generic perturbations are allowed in the interior of  $W \subset \widehat{W}$ , thus the inequalities  $\text{ind}(v) \geq -1$  and  $\text{ind}(v) \geq 0$  follow from standard transversality arguments as in [MS04]. The fact that no individual  $\widehat{J}_\tau$  admits more than one simple curve of index  $-1$  follows by showing that for generic families  $\{\widehat{J}_\tau\}$ , the map

$$\mathcal{M}^*(\{\widehat{J}_\tau\}) \times \mathcal{M}^*(\{\widehat{J}_{\tau'}\}) \rightarrow [0, 1] \times [0, 1] : ((u, \tau), (u', \tau')) \mapsto (\tau, \tau')$$

is transverse to the diagonal in  $[0, 1] \times [0, 1]$  outside of the diagonal in its domain. Here  $\mathcal{M}^*(\{\widehat{J}_\tau\})$  denotes the space of all pairs  $(u, \tau)$  such that  $\tau \in [0, 1]$  and  $u$  is an unparametrized somewhere injective finite-energy  $\widehat{J}_\tau$ -holomorphic curve that intersects the interior of  $W$ . This transversality result is probably also standard, but since we do not know a good reference for the proof, here is a sketch. One starts by defining a universal moduli space  $\mathcal{U}^*$  consisting of tuples  $(u, \tau, u', \tau', \{\widehat{J}_\tau\})$ , where  $\{\widehat{J}_\tau\}$  belongs to a suitable Banach manifold  $\mathcal{J}_{[0,1]}$  of homotopies of almost complex structures (e.g. of Floer  $C_\epsilon$  class or in  $C^k$  for some large  $k \in \mathbb{N}$ ), and  $(u, \tau)$  and  $(u', \tau')$  are two distinct elements of  $\mathcal{M}^*(\{\widehat{J}_\tau\})$ . The fact that they are distinct implies in particular that whenever  $\tau = \tau'$ , each of  $u$  and  $u'$  has an injective point where it does not intersect the other curve. Standard arguments via elliptic regularity and the implicit function theorem then show that  $\mathcal{U}^*$  is a differentiable Banach manifold and, moreover, that the map

$$\mathcal{U}^* \rightarrow [0, 1] \times [0, 1] : (u, \tau, u', \tau', \{\widehat{J}_\tau\}) \mapsto (\tau, \tau')$$

is a submersion. It follows that the preimage of the diagonal under this map is a submanifold  $\mathcal{U}_\Delta^* \subset \mathcal{U}^*$ , so applying the Sard-Smale theorem to the natural projection  $\mathcal{U}_\Delta^* \rightarrow \mathcal{J}_{[0,1]}$  provides a comeager subset of  $\mathcal{J}_{[0,1]}$  for which the desired transversality result is satisfied. In the final step, one can use the ‘‘Taubes trick’’ (cf. [MS04, §3.2] or [Wena, §4.4.2]) to replace  $\mathcal{J}_{[0,1]}$  with a suitable Fréchet manifold of *smooth* homotopies  $\{\widehat{J}_\tau\}$ .  $\square$

Genericity also implies that the existence of non-transverse intersections of somewhere injective  $\widehat{J}$ -holomorphic curves with fixed holomorphic hypersurfaces is a ‘‘codimension two phenomenon’’. We will be interested especially in controlling intersections with the union of the holomorphic vertebrae

$$\dot{\Sigma} := \dot{\Sigma}_1 \cup \dots \cup \dot{\Sigma}_r.$$

The next statement follows directly from the results of [CM07, §6].

**Lemma 6.7.** *For  $i \in \mathbb{Z}$ ,  $\ell \in \mathbb{N}$ ,  $\mathbf{k} := (k_1, \dots, k_\ell) \in \mathbb{N}^\ell$  and  $\tau \in [0, 1]$ , let  $\mathcal{M}_i^*(\widehat{J}_\tau; \dot{\Sigma}, \mathbf{k})$  denote the following moduli space of constrained  $\widehat{J}_\tau$ -holomorphic curves with  $\ell$  marked points: elements of  $\mathcal{M}_i^*(\widehat{J}_\tau; \dot{\Sigma}, \mathbf{k})$  are represented by tuples*

$$(S, j, \Gamma, (\zeta_1, \dots, \zeta_\ell), u)$$

such that  $u : (\dot{S} := S \setminus \Gamma, j) \rightarrow (\widehat{W}, \widehat{J}_\tau)$  is a somewhere injective finite-energy  $\widehat{J}_\tau$ -holomorphic curve of index  $i$  intersecting the interior of  $W$ ,  $\zeta_1, \dots, \zeta_\ell \in \dot{S}$  are distinct points, two tuples are equivalent if they are related by a biholomorphic map of their domains preserving the ordered sets of punctures  $\Gamma$  and marked points  $(\zeta_1, \dots, \zeta_\ell)$ , and  $u$  also satisfies the constraints

$$u(\zeta_j) \in \dot{\Sigma}$$

such that for each  $j = 1, \dots, \ell$ , the local intersection index of  $u$  with  $\dot{\Sigma}$  at  $\zeta_j$  is at least  $k_j$ . Then for almost every  $\tau$ , and in particular for  $\tau \in \{0, 1\}$ ,  $\mathcal{M}_i^*(\widehat{J}_\tau; \dot{\Sigma}, \mathbf{k})$  is a smooth manifold with

$$\dim \mathcal{M}_i^*(\widehat{J}_\tau; \dot{\Sigma}, \mathbf{k}) = i - 2 \sum_{j=1}^{\ell} (k_j - 1).$$

Moreover, the space  $\mathcal{M}_i^*(\{\widehat{J}_\tau\}; \dot{\Sigma}, \mathbf{k})$  of pairs  $(u, \tau)$  such that  $\tau \in [0, 1]$  and  $u \in \mathcal{M}_i^*(\widehat{J}_\tau; \dot{\Sigma}, \mathbf{k})$  is a smooth manifold of dimension  $i + 1 - 2 \sum_j (k_j - 1)$ , so in particular, this space is empty whenever  $i + 1 - 2 \sum_j (k_j - 1) < 0$ .  $\square$

Note that any curve in the ordinary moduli space without marked points gives rise to an element of the space in the above lemma whenever it intersects  $\dot{\Sigma}$ : one can simply add marked points wherever these intersections occur. Adding a marked point  $\zeta$  with the constraint  $u(\zeta) \in \dot{\Sigma}$  but without any constraint on the local intersection index does not change the dimension of the moduli space. Combining this observation with the usual results about generic transversality of the evaluation map from [MS04], we obtain:

**Lemma 6.8.** *Suppose  $\tau \in [0, 1]$  and  $u_0$  and  $u_1$  are somewhere injective  $\widehat{J}_\tau$ -holomorphic curves that both intersect the interior of  $W$  such that for each  $j = 0, 1$ , we have  $\text{ind}(u_j) \in \{-1, 0\}$ ,  $u_j$  intersects  $\dot{\Sigma}$  transversely, and all its asymptotic Reeb orbits are disjoint from those of  $\dot{\Sigma}$ . Then the sets  $\text{im } u_0 \cap \dot{\Sigma}$  and  $\text{im } u_1 \cap \dot{\Sigma}$  are disjoint.  $\square$*

A similar phenomenon in Siefring's intersection theory guarantees that generically, asymptotic contributions to the intersection counts  $u * v$  and  $\delta(u) + \delta_\infty(u)$  are zero whenever  $u$  and  $v$  are somewhere injective curves of sufficiently low index. Since no proof of this fact is available in the current literature, we shall only address the following simpler special case which suffices for our purposes. Fix a simply covered elliptic orbit  $\gamma : S^1 \rightarrow \Sigma \times S^1 \subset \widetilde{M}_\Sigma^+ : t \mapsto (z, t)$ , where  $\text{Morse}(z) = 2$ . Using the formula (3.13) for the Reeb vector field and the natural trivialization  $\gamma^* \Xi_+ = S^1 \times T_z \Sigma$ , the associated **asymptotic operator**  $\mathbf{A}_\gamma : \Gamma(\gamma^* \Xi_+) \rightarrow \Gamma(\gamma^* \Xi_+)$  (see e.g. [Wen10b, §3.2]) is identified with

$$C^\infty(S^1, T_z \Sigma) \rightarrow C^\infty(S^1, T_z \Sigma) : v \mapsto -j\dot{v} + \frac{\varepsilon}{K} \nabla_v \nabla H.$$

In light of the added assumption in §6.1 that  $\nabla^2 H : T_z \Sigma \rightarrow T_z \Sigma$  is  $j$ -linear when  $\text{Morse}(z) = 2$ ,  $\mathbf{A}_\gamma$  is therefore complex linear and thus has real 2-dimensional eigenspaces. Let  $V_\gamma^- \subset \Gamma(\gamma^* \Xi_+)$  denote the eigenspace with the largest negative eigenvalue, and suppose  $\mathcal{M}^*(\{\widehat{J}_\tau\})$  denotes any moduli space consisting of pairs  $(u, \tau)$  such that  $\tau \in [0, 1]$  and  $u$  is an unparametrized and possibly disconnected somewhere injective finite-energy  $\widehat{J}_\tau$ -holomorphic curve that intersects the interior of  $W$  with each of its connected components and has at least two punctures  $z_1, z_2$  asymptotic to  $\gamma$ . Then, as was discussed in §2.4, the asymptotic formulas of [HWZ96, Mor03, Sie08] give rise to an **asymptotic evaluation map**

$$\text{ev}^\infty = (\text{ev}_1^\infty, \text{ev}_2^\infty) : \mathcal{M}^*(\{\widehat{J}_\tau\}) \rightarrow V_\gamma^- \times V_\gamma^-,$$

where for  $i = 1, 2$ ,  $\text{ev}_i^\infty(u, \tau)$  associates to  $u$  the leading asymptotic eigenfunction of  $u$  at  $z_i$ . As with ordinary evaluation maps as in [MS04], one can show that this asymptotic evaluation map is a submersion when extended to the universal moduli space, hence generic choices of  $\{\hat{J}_\tau\}$  can make it transverse to any given submanifold of  $V_\gamma^- \times V_\gamma^-$ , in particular the diagonal. This leads to the following result, which is essentially Proposition 3.9 in [HT09].

**Lemma 6.9.** *For every  $\tau \in [0, 1]$  and every pair of somewhere injective  $\hat{J}_\tau$ -holomorphic curves  $u$  and  $v$  in  $\widehat{W}$  of index  $-1$  or  $0$  that intersect the interior of  $W$  and each have a puncture asymptotic to the same simply covered elliptic orbit in  $\text{Crit}_M(H) \times S^1 \subset \widetilde{M}_\Sigma^+$ , the values of the asymptotic evaluation maps at these two punctures are distinct. Moreover, the same holds for two punctures of a single curve with these same properties.  $\square$*

The main results of [Sie08] imply that whenever two punctures of the same sign are asymptotic to the same orbit, the asymptotic eigenvalue controlling the relative exponential decay rate of the ends to each other is extremal if and only if the asymptotic evaluation map for both punctures has distinct values. Since the relevant eigenspace in the case at hand is 2-dimensional, a non-extremal decay rate is equivalent to non-extremal asymptotic winding, so by the definitions of  $\delta_\infty(u)$  and  $u * v$  in [Sie11], Lemma 6.9 implies:

**Lemma 6.10.** *Suppose  $\tau \in [0, 1]$ ,  $u$  and  $v$  are somewhere injective finite-energy  $\hat{J}_\tau$ -holomorphic curves of index  $-1$  or  $0$  that intersect the interior of  $W$  and have non-identical images, and every Reeb orbit that occurs as an asymptotic orbit for both  $u$  and  $v$  is a simply covered elliptic orbit in  $\text{Crit}_M(H) \times S^1 \subset \widetilde{M}_\Sigma^+$ . Then  $u * v$  is the algebraic count of actual intersections of  $u$  and  $v$ , i.e. it includes no asymptotic contributions. Moreover, if every orbit occurring as an asymptotic orbit for two distinct ends of  $u$  is also a simple elliptic orbit in  $\text{Crit}_M(H) \times S^1$ , then  $\delta_\infty(u) = 0$ .  $\square$*

**6.3. Compactness for nicely embedded curves.** In this section we will state and prove two compactness results for certain classes of nicely embedded holomorphic curves in  $\widehat{W}$ , which will be used in §6.4 to describe the global structure of the quotient moduli spaces  $\widehat{\mathcal{M}}^\mathcal{F}(\hat{J})$  and  $\widehat{\mathcal{M}}^\mathcal{F}(\{\hat{J}_\tau\})$ . Recall from §2.3 that a somewhere injective finite-energy  $\hat{J}$ -holomorphic curve  $u$  in  $\widehat{W}$  is *nicely embedded* if its intersection numbers as defined by Siefring [Sie11] satisfy

$$\delta(u) = \delta_\infty(u) = 0 \quad \text{and} \quad u * u \leq 0;$$

moreover, if  $u$  is in the  $\mathbb{R}$ -invariant setting  $(\mathbb{R} \times M^+, J_+)$  and is not a trivial cylinder, then the condition reduces to  $u * u = 0$ . We saw in Proposition 4.15 that the latter is satisfied by every holomorphic page in  $\mathcal{M}^{\mathcal{F}+}(J_+)$ , so they are nicely embedded, and we will see that the same is therefore true for all the smooth somewhere injective curves in  $\widehat{\mathcal{M}}^\mathcal{F}(\hat{J})$ . Thus in order to understand the strata of  $\widehat{\mathcal{M}}^\mathcal{F}(\hat{J})$  that arise from nontrivial holomorphic buildings, it suffices to understand the closure of the space of nicely embedded curves.

**6.3.1. Moduli spaces of nicely embedded curves.** Adapting some notation from §5, we shall abbreviate  $\mathbf{m} := (m_1, \dots, m_r)$  and define

$$\mathcal{M}(\hat{J}; H; \mathbf{m}) \subset \mathcal{M}(\hat{J}), \quad \overline{\mathcal{M}}(\hat{J}; H; \mathbf{m}) \subset \overline{\mathcal{M}}(\hat{J})$$

as the spaces of curves/buildings  $u$  in  $(\widehat{W}, \hat{J})$  that satisfy the following conditions:

- (1) All asymptotic orbits of  $u$  are in  $\text{Crit}(H) \times S^1 \subset \widetilde{M}_\Sigma^+$  and the sum of all their periods is less than the bound  $T_1$  from Lemma 4.5;

- (2) For each  $i \in \{1, \dots, r\}$ , the sum of the covering multiplicities of all asymptotic orbits of  $u$  in the component  $\Sigma_i \times S^1 \subset \widetilde{M}_\Sigma^+$  is at most  $m_i$ ;
- (3)  $u$  has (arithmetic) genus 0.

Define subsets

$$\mathcal{M}^{\text{nice}}(\widehat{J}; H; \mathbf{m}) \subset \mathcal{M}(\widehat{J}; H; \mathbf{m}), \quad \overline{\mathcal{M}}^{\text{nice}}(\widehat{J}; H; \mathbf{m}) \subset \overline{\mathcal{M}}(\widehat{J}; H; \mathbf{m}),$$

where the first consists of all  $u \in \mathcal{M}(\widehat{J}; H; \mathbf{m})$  that are nicely embedded, and the second is the closure of the first with respect to the SFT-topology. Given the 1-parameter family  $\{\widehat{J}_\tau\}$ , we analogously define spaces of pairs  $(u, \tau)$  for  $\tau \in [0, 1]$ , which form subsets

$$\begin{aligned} \mathcal{M}^{\text{nice}}(\{\widehat{J}_\tau\}; H; \mathbf{m}) &\subset \mathcal{M}(\{\widehat{J}_\tau\}; H; \mathbf{m}) \subset \mathcal{M}(\{\widehat{J}_\tau\}), \\ \overline{\mathcal{M}}^{\text{nice}}(\{\widehat{J}_\tau\}; H; \mathbf{m}) &\subset \overline{\mathcal{M}}(\{\widehat{J}_\tau\}; H; \mathbf{m}) \subset \overline{\mathcal{M}}(\{\widehat{J}_\tau\}), \end{aligned}$$

where we should clarify that  $\overline{\mathcal{M}}^{\text{nice}}(\{\widehat{J}_\tau\}; H; \mathbf{m})$  is defined as the closure of  $\mathcal{M}^{\text{nice}}(\{\widehat{J}_\tau\}; H; \mathbf{m})$  in  $\overline{\mathcal{M}}(\{\widehat{J}_\tau\})$ ; note that this may in general be larger than the space of pairs  $(u, \tau)$  with  $u \in \overline{\mathcal{M}}^{\text{nice}}(\widehat{J}_\tau; H; \mathbf{m})$ , since it includes all limits of SFT-convergent sequences  $(u_\nu, \tau_\nu) \in \mathcal{M}^{\text{nice}}(\{\widehat{J}_\tau\}; H; \mathbf{m})$ , where the  $\tau_\nu \in [0, 1]$  can vary. For each  $i \in \mathbb{Z}$ , we denote by

$$\begin{aligned} \mathcal{M}_i^{\text{nice}}(\widehat{J}; H; \mathbf{m}) &\subset \mathcal{M}^{\text{nice}}(\widehat{J}; H; \mathbf{m}), \\ \overline{\mathcal{M}}_i(\{\widehat{J}_\tau\}; H; \mathbf{m}) &\subset \overline{\mathcal{M}}(\{\widehat{J}_\tau\}; H; \mathbf{m}) \end{aligned}$$

and so forth the subsets defined by the condition  $\text{ind}(u) = i$ . Our genericity assumptions, in particular Lemma 6.6, imply that a somewhere injective curve in  $\mathcal{M}(\widehat{J}_\tau; H; \mathbf{m})$  for  $\tau \in [0, 1]$  will never have index less than  $-1$  if it intersects the interior of  $W$ . Outside of this region, i.e. in  $\widehat{\mathcal{N}}_-(\partial E) \subset \widehat{W}$ ,  $\widehat{J}_\tau$  was defined to match the specially constructed model  $J_+$  from §3.7 and is thus neither generic nor  $\tau$ -dependent, so we must still say something about indices of curves with images contained entirely in  $\widehat{\mathcal{N}}_-(\partial E)$ .

**Lemma 6.11.** *For every  $\tau \in [0, 1]$ , every curve  $u \in \mathcal{M}(\widehat{J}_\tau; H; \mathbf{m})$  with image contained in  $\widehat{\mathcal{N}}_-(\partial E)$  is an embedded leaf of  $\mathcal{F}_+$  and is isotopic to one of the holomorphic pages in  $\mathcal{M}^{\mathcal{F}_+}(J_+)$ . In particular, it has index 1 or 2.*

*Proof.* Recall that the subset  $\widehat{\mathcal{N}}_+(\partial E) \subset \widehat{\mathcal{N}}_-(\partial E)$  is identified canonically with the half-symplectization  $[0, \infty) \times M^+$ , and it is also a retraction of  $\widehat{\mathcal{N}}_-(\partial E)$ , thus we can choose a diffeomorphism  $\widehat{\mathcal{N}}_-(\partial E) \cong [0, \infty) \times M^+$  that matches the canonical one near infinity. Under this identification, we observe that a curve  $u \in \mathcal{M}(\widehat{J}_\tau; H; \mathbf{m})$  contained in  $\widehat{\mathcal{N}}_-(\partial E)$  must intersect  $[0, \infty) \times \widetilde{M}_P^+$ , as otherwise it would be confined to the neighborhood of a spinal component in which the homological sum of all its asymptotic orbits is nonzero, producing a contradiction. Now if  $u$  is not a leaf of  $\mathcal{F}_+$ , observe that it also cannot be a multiple cover of any leaf since the total multiplicities of the orbits in each component of the spine would then be greater than what is allowed for curves in  $\mathcal{M}(\widehat{J}_\tau; H; \mathbf{m})$ . It follows that  $u$  has at least one isolated intersection with some leaf  $v \in \mathcal{F}_+$  that stays away from  $M^-$  and is thus an asymptotically cylindrical  $\widehat{J}$ -holomorphic curve; indeed, the entirety of the region  $(-1, \infty) \times \widetilde{M}_P \subset \widehat{E}$  is foliated by leaves of this type, which are tangent to  $\Xi_+$ . Positivity of intersections therefore implies  $u * v > 0$ . However, a small alteration to the proof of Lemma 4.16 shows that  $u * v = 0$  for every holomorphic page  $v \in \mathcal{F}_+$ . Indeed, this is immediate if  $u$  has no punctures, as one can then translate  $v$  upward in  $[0, \infty) \times M^+$  to

make it disjoint from  $u$ . If  $u$  does have punctures, then one can modify it as in the proof of Lemma 4.16 by a homotopy through asymptotically cylindrical maps so that its intersection with  $\widehat{\mathcal{N}}_+(\partial E)$  is a union of trivial cylinders, and then compute the intersection number again via Lemma 4.14. This contradiction proves the lemma.  $\square$

Further constraints on indices hold for nicely embedded curves. The following lemma implies that  $\overline{\mathcal{M}}_i^{\text{nice}}(\widehat{J}_\tau; H; \mathbf{m})$  is always empty for  $i > 2$ , and moreover, all buildings  $u$  in  $\overline{\mathcal{M}}_1^{\text{nice}}(\widehat{J}_\tau; H; \mathbf{m})$  or  $\overline{\mathcal{M}}_2^{\text{nice}}(\widehat{J}_\tau; H; \mathbf{m})$  have only simply covered asymptotic orbits, all elliptic in the latter case, with exactly one hyperbolic orbit in the former case, and  $u * u = 0$ . For  $u$  in  $\overline{\mathcal{M}}_{-1}^{\text{nice}}(\widehat{J}_\tau; H; \mathbf{m})$  or  $\overline{\mathcal{M}}_0^{\text{nice}}(\widehat{J}_\tau; H; \mathbf{m})$ ,  $u * u$  can be either  $-1$  or  $0$  depending on an easily denumerable list of combinations of elliptic/hyperbolic orbits with at most one doubly covered orbit.

**Lemma 6.12.** *For any  $(u, \tau) \in \overline{\mathcal{M}}^{\text{nice}}(\{\widehat{J}_\tau\}; H; \mathbf{m})$ , all asymptotic orbits of  $u$  are at most doubly covered,  $-1 \leq \text{ind}(u) \leq 2$ ,  $u * u \in \{-1, 0\}$  and*

$$2(u * u + 1) = \text{ind}(u) + \#\Gamma_0 + 2\#\Gamma^2 \in \{0, 2\},$$

where  $\Gamma_0$  denotes the set of punctures of  $u$  at which the asymptotic orbit has even Conley-Zehnder index, and  $\Gamma^2$  is the set of punctures at which the orbit is doubly covered.

*Proof.* Denote the set of punctures of  $u$  by  $\Gamma$  and for each  $m \in \mathbb{N}$ , let  $\Gamma^m \subset \Gamma$  denote the subset at which the orbit has covering multiplicity  $m$ . By assumption,  $u$  is either nicely embedded or is the limit in the SFT-topology of a sequence  $u^\nu$  of nicely embedded curves as  $\nu \rightarrow \infty$ , thus it suffices to prove the lemma under the assumption that  $u$  itself is nicely embedded. Given this, we have  $\delta(u) = \delta_\infty(u) = 0$  and  $u * u \leq 0$ , and we already know  $\text{ind}(u) \geq -1$  due to Lemmas 6.6 and 6.11. To compute  $u * u$ , we first plug the stated conditions into the adjunction formula (2.9), obtaining  $c_N(u) = u * u - [\bar{\sigma}(u) - \#\Gamma]$ , thus by (2.11),

$$(6.2) \quad \begin{aligned} \text{ind}(u) - 2 + \#\Gamma_0 &= 2(u * u - [\bar{\sigma}(u) - \#\Gamma]) \\ &\leq -2[\bar{\sigma}(u) - \#\Gamma]. \end{aligned}$$

Since the index formula implies that  $\text{ind}(u)$  and  $\#\Gamma_0$  always have the same parity, and  $\text{ind}(u) \geq -1$ , the left hand side of this inequality is at least  $-2$ , implying  $\bar{\sigma}(u) - \#\Gamma \leq 1$ . But Lemma 4.12 implies that all the asymptotic orbits  $\gamma$  of  $u$  satisfy  $\alpha_-(\gamma) = 0$  in the  $S^1$ -invariant trivialization, so Lemma 2.8 then implies

$$\bar{\sigma}(u) - \#\Gamma = \sum_{m \in \mathbb{N}} m \#\Gamma^m - \#\Gamma = \sum_{m \geq 2} (m - 1) \#\Gamma^m \leq 1,$$

thus  $\#\Gamma^m = 0$  for all  $m \geq 3$  and  $\bar{\sigma}(u) - \#\Gamma = \#\Gamma^2 \in \{0, 1\}$ . The stated identity now follows from (6.2).  $\square$

**6.3.2. Statements of the main compactness results.** To simplify the wording in the following statements, we will describe only the *nontrivial* components in each level of a holomorphic building, so that each level should be understood to consist of the disjoint union of the specified curves with some trivial cylinders. In cases where multiple nontrivial curves appear in upper levels (e.g. case (2d) in Prop. 6.13 below), the actual number of upper levels may vary depending on whether these curves occupy the same level or not. Schematic representations of the index 2 buildings described in the following two results are shown in Figures 9 and 10, where the correct labelling of the elliptic and hyperbolic orbits in these pictures can be deduced from Lemma 6.12 above. In each case, minor simplifications of the same pictures produce

representations of the relevant buildings with lower index as well, e.g. the index 1 buildings in Proposition 6.13 look like Figures 9C or 9D with one gradient flow cylinder removed and possibly everything shifted up one level.

**Proposition 6.13.** *Assume  $\hat{J}$  is generic so that the results of §6.2 hold. Then  $\mathcal{M}_0^{\text{nice}}(\hat{J}; H; \mathbf{m})$  is a finite set and thus matches  $\overline{\mathcal{M}}_0^{\text{nice}}(\hat{J}; H; \mathbf{m})$ . Buildings in  $\overline{\mathcal{M}}_1^{\text{nice}}(\hat{J}; H; \mathbf{m}) \setminus \mathcal{M}_1^{\text{nice}}(\hat{J}; H; \mathbf{m})$  all fit either of the following descriptions:*

- (1a) *The main level is empty and the upper level is a holomorphic page in  $\mathcal{M}_1^{\mathcal{F}^+}(J_+)$ ;*
- (1b) *The main level is a curve  $u_0 \in \mathcal{M}_0^{\text{nice}}(\hat{J}; H; \mathbf{m})$  with  $u_0 * u_0 = 0$ , and the upper level contains a single gradient flow cylinder in  $\mathcal{M}_1^{\mathcal{F}^+}(J_+)$ .*

Finally, every building in  $\overline{\mathcal{M}}_2^{\text{nice}}(\hat{J}; H; \mathbf{m}) \setminus \mathcal{M}_2^{\text{nice}}(\hat{J}; H; \mathbf{m})$  fits one of the following descriptions:

- (2a) *The main level is empty and there are either one or two upper levels representing an element of  $\overline{\mathcal{M}}_2^{\mathcal{F}^+}(J_+)$  (the variant with only one upper level is shown in Figure 9A);<sup>9</sup>*
- (2b) *There are no upper levels, and the main level is a nodal curve in  $\widehat{W}$ , having two connected components  $u_{\pm} \in \mathcal{M}_0^{\text{nice}}(\hat{J}; H; \mathbf{m})$  with  $u_+ * u_+ = u_- * u_- = -1$  and  $u_+ * u_- = 1$ , and intersecting transversely at a single node (Figure 9B);*
- (2c) *The main level consists of a curve  $u_0 \in \mathcal{M}_1^{\text{nice}}(\hat{J}; H; \mathbf{m})$ , and there is one upper level containing a single gradient flow cylinder in  $\mathcal{M}_1^{\mathcal{F}^+}(J_+)$  (Figure 9C);*
- (2d) *Case (1b) with a second gradient flow cylinder in  $\mathcal{M}_1^{\mathcal{F}^+}(J_+)$  added in an upper level (Figure 9D);*
- (2e) *The main level consists of a curve  $u_0 \in \mathcal{M}_0^{\text{nice}}(\hat{J}; H; \mathbf{m})$  which has  $u_0 * u_0 = 0$  and elliptic asymptotic orbits including one that is doubly covered, and there is one upper level containing an index 2 branched double cover of the trivial cylinder over this orbit, with two positive punctures and one negative (Figure 9E).*

**Proposition 6.14.** *Assume the homotopy  $\{\hat{J}_\tau\}$  is generic so that the results of §6.2 hold. Then there exists a finite set of parameter values*

$$I^{\text{sing}} \subset (0, 1)$$

such that  $\mathcal{M}_{-1}^{\text{nice}}(\{\hat{J}_\tau\}; H; \mathbf{m})$  contains exactly one pair  $(u, \tau)$  for each  $\tau \in I^{\text{sing}}$  and no other elements, hence  $\overline{\mathcal{M}}_{-1}^{\text{nice}}(\{\hat{J}_\tau\}; H; \mathbf{m}) = \mathcal{M}_{-1}^{\text{nice}}(\{\hat{J}_\tau\}; H; \mathbf{m})$ . Pairs  $(u, \tau) \in \overline{\mathcal{M}}_i^{\text{nice}}(\{\hat{J}_\tau\}; H; \mathbf{m})$  for  $i = 0, 1, 2$  and  $\tau \in [0, 1] \setminus I^{\text{sing}}$  are described by the list in Proposition 6.13, while if  $\tau \in I^{\text{sing}}$ , the list must be supplemented as follows. For  $i = 0$ ,  $u$  can either be a smooth curve or one of the following:

- (0a) *The main level is a curve  $u_0 \in \mathcal{M}_{-1}^{\text{nice}}(\hat{J}_\tau; H; \mathbf{m})$  with  $u_0 * u_0 = -1$  or  $0$ , and there is one upper level containing a gradient flow cylinder in  $\mathcal{M}_1^{\mathcal{F}^+}(J_+)$ ;*
- (0b) *The main level is a curve  $u_0 \in \mathcal{M}_{-1}^{\text{nice}}(\hat{J}_\tau; H; \mathbf{m})$  with  $u_0 * u_0 = 0$  whose asymptotic orbits include one that is hyperbolic and doubly covered, while the upper level consists of an index 1 unbranched double cover of a gradient flow cylinder in  $\mathcal{M}_1^{\mathcal{F}^+}(J_+)$ .*

The cases with index 1 not described in Proposition 6.13 can include the following:

---

<sup>9</sup>Note that the same diagram, but with a nonempty curve in  $W$  instead of  $\mathbb{R} \times M$ , would represent an element of  $\mathcal{M}_2^{\text{nice}}(\hat{J}; H; \mathbf{m})$ .

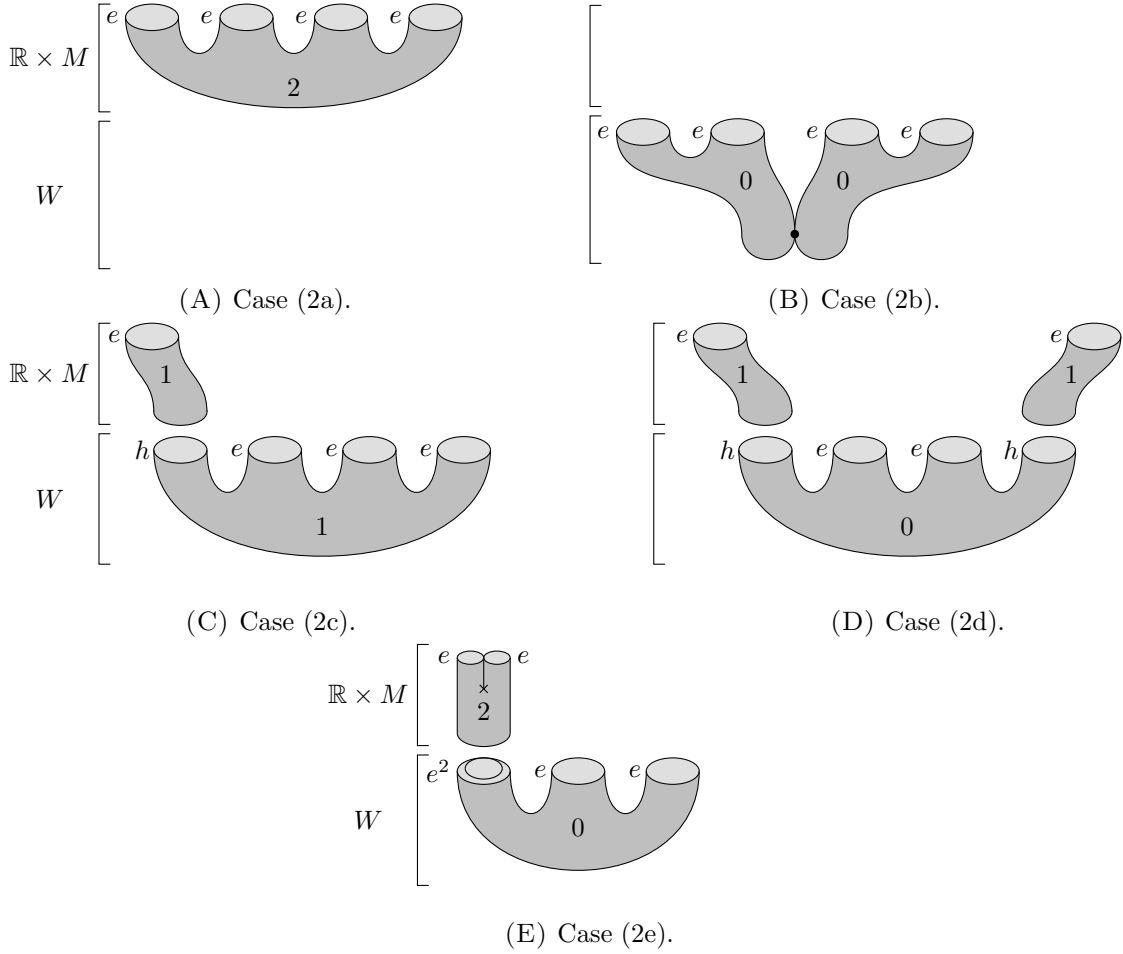

FIGURE 9. The possible index 2 buildings that can arise in the compactification of the moduli space for generic  $J$ . The asymptotic orbits are labelled with  $e$  or  $h$  to indicate elliptic/hyperbolic simple orbits in the spine. The notation of  $e^2$  denotes a double cover of an elliptic orbit. The components of each building are labelled with their Fredholm index.

- (1c) There are no upper levels, and the main level is a nodal curve in  $\widehat{W}$ , having two connected components  $u_0 \in \mathcal{M}_0^{\text{nice}}(\widehat{J}_\tau; H; \mathbf{m})$  and  $u_{-1} \in \mathcal{M}_{-1}^{\text{nice}}(\widehat{J}_\tau; H; \mathbf{m})$  with  $u_0 * u_0 = u_{-1} * u_{-1} = -1$  and  $u_0 * u_{-1} = 1$ , and intersecting transversely at a single node;
- (1d) Case (0a) with  $u_0 * u_0 = 0$  and a second gradient flow cylinder in  $\mathcal{M}_1^{\mathcal{F}^+}(J_+)$  added in an upper level;
- (1e) The main level is a curve  $u_0 \in \mathcal{M}_{-1}^{\text{nice}}(\widehat{J}_\tau; H; \mathbf{m})$  with  $u_0 * u_0 = 0$  whose asymptotic orbits include one that is elliptic and doubly covered, and there is one upper level containing an index 2 branched double cover of the trivial cylinder over this elliptic orbit;
- (1f) The main level is a curve  $u_0 \in \mathcal{M}_{-1}^{\text{nice}}(\widehat{J}_\tau; H; \mathbf{m})$  with  $u_0 * u_0 = 0$  whose asymptotic orbits include one that is hyperbolic and doubly covered, and there are two upper levels: the first contains an index 1 branched double cover of the trivial cylinder over

the hyperbolic orbit with two positive punctures and one negative, and a gradient flow cylinder in  $\mathcal{M}_1^{\mathcal{F}^+}(J_+)$  is stacked on top of this in a second upper level;

Finally, the following additional possibilities for buildings of index 2 can occur:

- (2f) Case (1d) with a third gradient flow cylinder in  $\mathcal{M}_1^{\mathcal{F}^+}(J_+)$  added in an upper level (Figure 10F);
- (2g) Case (1e) with a gradient flow cylinder in  $\mathcal{M}_1^{\mathcal{F}^+}(J_+)$  added in an upper level (Figure 10G);
- (2h) Case (1c) with a gradient flow cylinder in  $\mathcal{M}_1^{\mathcal{F}^+}(J_+)$  added in an upper level, connected to the index  $-1$  curve along its unique hyperbolic orbit (Figure 10H);
- (2i) Case (1f) with an extra gradient flow cylinder in  $\mathcal{M}_1^{\mathcal{F}^+}(J_+)$  added on top (Figure 10I);
- (2j) Case (0b) with an index 2 branched double cover of the trivial cylinder over an elliptic orbit stacked on top of the unbranched cover (Figure 10J);
- (2k) The main level is a curve  $u_0 \in \mathcal{M}_{-1}^{\text{nice}}(\hat{J}_\tau; H; \mathbf{m})$  with  $u_0 * u_0 = 0$  whose asymptotic orbits include one that is hyperbolic and doubly covered, and there is one upper level containing an index 3 branched double cover of a gradient flow cylinder in  $\mathcal{M}_1^{\mathcal{F}^+}(J_+)$  (Figure 10K).<sup>10</sup>

*Remark 6.15.* In the scenarios in Propositions 6.13 and 6.14 involving multiple components in one level without nodes, it may happen that some of these components are identical, but this is only possible if at least one of the multiplicities  $m_1, \dots, m_r$  is greater than 1. The latter is also a necessary condition for any of the scenarios that involve doubly covered curves.

**6.3.3. The upper levels.** The proofs of Propositions 6.13 and 6.14 will follow by considering inequalities that relate the Fredholm index and self-intersection numbers. Notice that the statement of Proposition 6.13 is precisely what remains of Proposition 6.14 if one adds the assumption that somewhere injective curves of index  $-1$  in  $\widehat{W}$  do not exist. With this understood and Lemmas 6.6 and 6.11 in hand, we will use the same argument to prove both compactness results.

For the rest of §6.3, we shall fix  $\tau_\infty \in [0, 1]$  and a holomorphic building

$$u^\infty \in \overline{\mathcal{M}}(\hat{J}_{\tau_\infty}; H; \mathbf{m})$$

and work on deriving constraints on the structure of  $u^\infty$ . We will later add the assumption that  $(u^\infty, \tau_\infty) \in \overline{\mathcal{M}}^{\text{nice}}(\{\hat{J}_\tau\}; H; \mathbf{m})$ , but it will be useful to wait a bit before imposing such a restriction.

**Lemma 6.16.** *All components in upper levels of  $u^\infty \in \overline{\mathcal{M}}(\hat{J}_{\tau_\infty}; H; \mathbf{m})$  are covers of leaves of  $\mathcal{F}_+$ . Moreover, the main level of  $u^\infty$  is empty if and only if  $u^\infty$  contains a component whose image is a holomorphic page; in that case, the bottommost nonempty level of  $u^\infty$  consists of a single embedded holomorphic page, all other components are either trivial cylinders or embedded gradient flow cylinders, and there are no nodes.*

*Proof.* The period constraint on the asymptotic orbits implies the same constraint on all breaking orbits via Proposition 2.4, so the first claim then follows from Lemma 4.17. Given this, the rest follows from the assumptions about total multiplicities of orbits in the components  $\Sigma_i \times S^1$ : in particular, these constraints imply that  $u^\infty$  can contain no more than

<sup>10</sup>Notice that cases (2i) and (2j) can arise as the boundary of the space of configurations from case (2k).



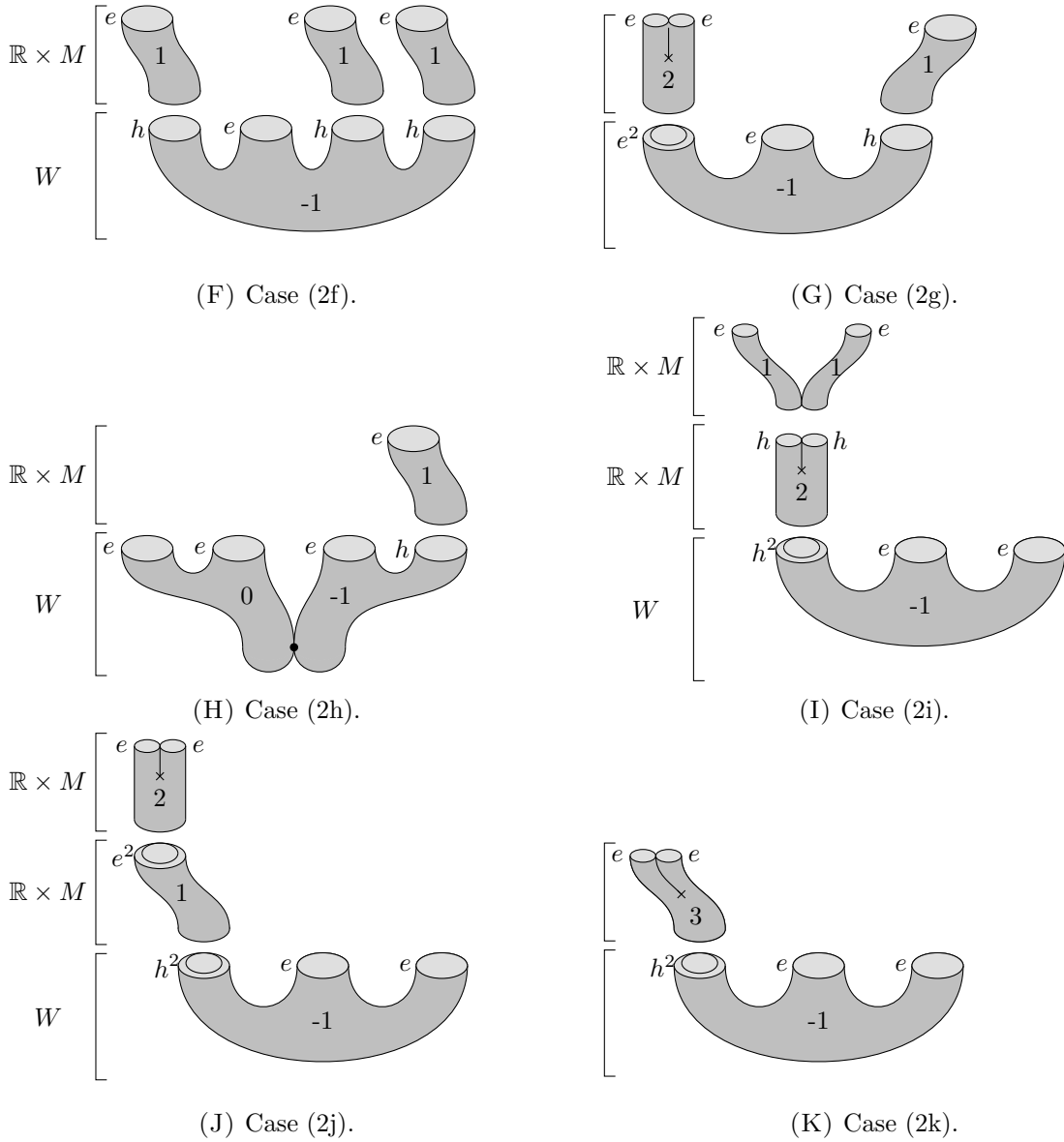

FIGURE 10. The buildings that can arise for exceptional homotopy values, but that are not in Figure 9. Notice that translation invariance of  $J$  in  $\mathbb{R} \times M$  precludes  $-1$  curves in upper levels, so the exceptional buildings must feature a  $-1$  curve in  $W$ .

one holomorphic page, which cannot be multiply covered, and if it is present then there can be nothing in any level below it. Moreover, the fact that these pages have simply covered asymptotic orbits implies since the arithmetic genus is zero that all curves in levels above the page are simply covered cylinders, and nodes cannot appear. Conversely, if the main level is empty, then some component must be a holomorphic page since all other kinds of leaves have negative punctures.  $\square$

6.3.4. *Index relations.* Let us now fix some notation. We shall write the set of (necessarily positive) punctures of  $u^\infty$  as  $\Gamma(u^\infty)$ , and for each  $z \in \Gamma(u^\infty)$ , let  $\gamma_z$  denote the corresponding asymptotic orbit, and  $m_z \in \mathbb{N}$  its covering multiplicity.<sup>11</sup> For each  $m \in \mathbb{N}$ , define the subset

$$\Gamma^m(u^\infty) := \{z \in \Gamma(u^\infty) \mid m_z = m\},$$

hence  $\Gamma(u^\infty) = \Gamma^1(u^\infty) \amalg \Gamma^2(u^\infty) \amalg \dots$ . We shall also write

$$\Gamma(u^\infty) = \Gamma_0(u^\infty) \amalg \Gamma_1(u^\infty),$$

where  $\Gamma_0(u^\infty)$  and  $\Gamma_1(u^\infty)$  denote the sets of punctures  $z$  at which  $\mu_{\text{CZ}}(\gamma_z)$  is even or odd respectively. By Lemma 4.5, this means  $\mu_{\text{CZ}}(\gamma_z) = \ell$  with respect to the  $S^1$ -invariant trivialization for  $z \in \Gamma_\ell(u^\infty)$ ,  $\ell = 0, 1$ .

In light of Lemma 6.16, we shall assume from now on that the main level of  $u^\infty$  is nonempty, all upper levels consist of covers of trivial cylinders or gradient flow cylinders, and all breaking orbits are covers of orbits in  $\text{Crit}_M(H) \times S^1 \subset \widetilde{M}_\Sigma^+$  with period less than  $T_1$ . Denote the nonconstant connected components of the main level by  $u_1, \dots, u_L$ , and write each of these as

$$u_i = v_i \circ \varphi_i,$$

where  $v_i$  is a somewhere injective curve and  $\varphi_i$  is a holomorphic branched cover of punctured Riemann surfaces whose unique extension over the punctures gives a map of closed Riemann surfaces with degree

$$k_i := \deg(\varphi_i) \in \mathbb{N}.$$

We shall use the same notation  $\Gamma(u_i)$ ,  $\Gamma(v_i)$  with subsets  $\Gamma^m(u_i)$ ,  $\Gamma_0(u_i)$  etc. for the (again positive) punctures of  $u_i$  and  $v_i$  and their asymptotic orbits and covering multiplicities.

Lemmas 6.6 and 6.11 imply  $\text{ind}(v_i) \geq -1$ , and  $\text{ind}(v_i) \geq 0$  if  $\widehat{J}_{\tau_\infty}$  is generic. If  $\text{ind}(v_i) = -1$ , then we notice from the index formula (2.7) that  $\Gamma_0(v_i)$  cannot be empty, thus in general, our genericity assumptions always imply

$$(6.3) \quad \text{ind}(v_i) + \#\Gamma_0(v_i) \geq 0.$$

We will later make use of the fact that if  $(u^\infty, \tau_\infty) \in \overline{\mathcal{M}}^{\text{nice}}(\{\widehat{J}_\tau\}; H; \mathbf{m})$ , then Lemma 6.12 implies a corresponding upper bound for  $\text{ind}(u^\infty) + \#\Gamma_0(u^\infty)$  plus associated counts of multiply covered punctures, and our strategy will be to combine these relations with (6.3) for deriving constraints on  $u^\infty$ . The workhorse result for this purpose will be Lemma 6.18 below.

As preparation, we must first relate the indices of the curves  $v_i$  and their multiple covers  $u_i$ . Given  $z \in \Gamma(u_i)$ , let  $k_z \in \mathbb{N}$  denote the *branching order* of  $\varphi_i$  at  $z$ , meaning that  $\varphi_i$  is a  $k_i$ -to-1 covering map on the cylindrical end near this puncture. These numbers are related to the total degree of  $\varphi_i$  by

$$(6.4) \quad k_i = \sum_{z \in \varphi_i^{-1}(\zeta)} k_z \quad \text{for any } \zeta \in \Gamma(v_i).$$

We shall use the same notation for branching orders at critical points  $z \in \text{Crit}(\varphi_i)$ , so that the algebraic count of critical points of  $\varphi_i$  is

$$Z(d\varphi_i) := \sum_{z \in \text{Crit}(\varphi_i)} (k_z - 1) \geq 0;$$

---

<sup>11</sup>The reader should beware that the notation  $\gamma_z$  was used with a slightly different meaning in earlier sections.

we emphasize that  $\varphi_i$  is being viewed here as a branched cover between *punctured* Riemann surfaces, so the sum over  $z \in \text{Crit}(\varphi_i)$  does not include points in  $\Gamma(u_i)$ . The asymptotic orbits of  $u_i$  and  $v_i$  are now related by

$$\gamma_z = \gamma_\zeta^{k_z} \quad \text{for } z \in \Gamma(u_i) \text{ and } \zeta = \varphi_i(z) \in \Gamma(v_i),$$

where we are abusing notation by identifying  $\varphi_i$  with its holomorphic extension over the punctures. Since  $u^\infty$  has arithmetic genus 0, all the components  $u_i$  and  $v_i$  also have genus zero and the Riemann-Hurwitz formula therefore implies

$$(6.5) \quad Z(d\varphi_i) + \sum_{z \in \Gamma(u_i)} (k_z - 1) = 2(k_i - 1).$$

Since the breaking orbits are all in  $\text{Crit}_M(H) \times S^1$  with periods less than  $T_1$ , the orbits  $\gamma_z$  for  $z \in \Gamma_\ell(u_i)$  or  $z \in \Gamma_\ell(v_i)$  with  $\ell = 0, 1$  also satisfy  $\mu_{\text{CZ}}(\gamma_z) = \ell$  with respect to the  $S^1$ -invariant trivialization. Moreover, the extension of  $\varphi_i$  over the punctures maps  $\Gamma_\ell(u_i)$  to  $\Gamma_\ell(v_i)$  for each  $\ell = 0, 1$ . Plugging this information into the index formula (2.7) gives

$$\begin{aligned} \text{ind}(u_i) &= -2 + \#\Gamma(u_i) + \#\Gamma_1(u_i) + 2c_1(u_i), \\ \text{ind}(v_i) &= -2 + \#\Gamma(v_i) + \#\Gamma_1(v_i) + 2c_1(v_i), \end{aligned}$$

where  $c_1(v_i)$  and  $c_1(u_i) = k_i c_1(v_i) \in \mathbb{Z}$  are abbreviations for the relative first Chern numbers of the pulled back tangent bundles with respect to the  $S^1$ -invariant trivialization at the ends. A quick computation combining this with (6.4) and (6.5) yields:

**Lemma 6.17.** *For each  $i = 1, \dots, L$ ,*

$$\begin{aligned} \text{ind}(u_i) &= k_i \text{ind}(v_i) + Z(d\varphi_i) - \sum_{z \in \Gamma_1(u_i)} (k_z - 1) \\ &= k_i [\text{ind}(v_i) + \#\Gamma_0(v_i)] + Z(d\varphi_i) - \sum_{z \in \Gamma_1(u_i)} (k_z - 1) - \sum_{z \in \Gamma_0(u_i)} k_z. \end{aligned}$$

□

**Lemma 6.18.** *If  $u^\infty \in \overline{\mathcal{M}}(\widehat{J}_{\tau_\infty}; H; \mathbf{m})$  has no nodes, then it satisfies*

$$\begin{aligned} \text{ind}(u^\infty) + \#\Gamma_0(u^\infty) + 2 \sum_{m \geq 2} (m-1) \#\Gamma^m(u^\infty) \\ = 2(L-1) + \sum_{i=1}^L \left( k_i [\text{ind}(v_i) + \#\Gamma_0(v_i)] + Z(d\varphi_i) \right. \\ \left. + \sum_{\zeta \in \Gamma(v_i)} \sum_{z \in \varphi_i^{-1}(\zeta)} [k_z(2m_\zeta - 1) - 1] \right). \end{aligned}$$

*Proof.* If  $u^\infty$  has no upper levels, then we can replace it with an unstable building having one upper level that consists only of trivial cylinders. Let us therefore denote by  $u^+$  the (possibly disconnected) holomorphic building in  $(\mathbb{R} \times M^+, J_+)$  consisting of all upper levels of  $u^\infty$ , and assume without loss of generality that  $u^+$  is a disjoint union of  $L_+ \geq 1$  connected buildings. We can compute  $L_+$  from the fact that  $u^\infty$  has arithmetic genus zero: indeed,  $u^\infty$  gives rise to a contractible graph whose vertices correspond to the connected components  $u_1, \dots, u_L$

and the  $L_+$  connected buildings forming  $u^+$ , and with edges corresponding to the punctures of  $u_1, \dots, u_L$ , so its Euler characteristic is  $1 = L + L_+ - \sum_{i=1}^L \#\Gamma(u_i)$ , implying

$$L_+ = -(L - 1) + \sum_{i=1}^L \#\Gamma(u_i).$$

Meanwhile, the positive punctures of  $u^+$  are in one-to-one correspondence with those of  $u^\infty$ , and its negative punctures correspond to the punctures of  $u_1, \dots, u_L$ , thus Lemma 4.9 combines with the above relation and gives

$$\begin{aligned} \text{ind}(u^+) &= -2L_+ + \#\Gamma_0(u^\infty) + 2\#\Gamma_1(u^\infty) + \sum_{i=1}^L \#\Gamma_0(u_i) \\ (6.6) \quad &= 2(L - 1) - \sum_{i=1}^L [\#\Gamma_0(u_i) + 2\#\Gamma_1(u_i)] + \#\Gamma_0(u^\infty) + 2\#\Gamma_1(u^\infty). \end{aligned}$$

Note that since each component of  $u^+$  has image in  $\mathbb{R} \times \widetilde{M}_\Sigma^+$  and the latter fibers over  $S^1$ , there is a well-defined degree of the projection to  $S^1$ . In particular, the total degree of the positive ends agrees with the total degree of the negative ends, implying

$$\sum_{z \in \Gamma(u^\infty)} m_z = \sum_{i=1}^L \sum_{z \in \Gamma(u_i)} m_z = \sum_{i=1}^L \sum_{\zeta \in \Gamma(v_i)} \sum_{z \in \varphi_i^{-1}(\zeta)} k_z m_\zeta.$$

The expression on the left hand side of this equation can also be rewritten as  $\sum_{m \in \mathbb{N}} m \#\Gamma^m(u^\infty)$ , thus

$$\begin{aligned} \#\Gamma_0(u^\infty) + 2 \sum_{m \geq 2} (m - 1) \#\Gamma^m(u^\infty) &= \#\Gamma_0(u^\infty) + 2 \sum_{z \in \Gamma(u^\infty)} m_z - 2\#\Gamma(u^\infty) \\ (6.7) \quad &= -\#\Gamma_0(u^\infty) - 2\#\Gamma_1(u^\infty) + 2 \sum_{i=1}^L \sum_{\zeta \in \Gamma(v_i)} \sum_{z \in \varphi_i^{-1}(\zeta)} k_z m_\zeta. \end{aligned}$$

Now writing  $\text{ind}(u^\infty) = \text{ind}(u^+) + \sum_{i=1}^L \text{ind}(u_i)$  and applying Lemma 6.17 along with (6.6) and (6.7), we find that  $\text{ind}(u^\infty) + \#\Gamma_0(u^\infty) + 2 \sum_{m \geq 2} (m-1) \#\Gamma^m(u^\infty)$  equals

$$\begin{aligned}
& 2(L-1) - \sum_{i=1}^L [\#\Gamma_0(u_i) + 2\#\Gamma_1(u_i)] + \#\Gamma_0(u^\infty) + 2\#\Gamma_1(u^\infty) \\
& + \sum_{i=1}^L \left( k_i [\text{ind}(v_i) + \#\Gamma_0(v_i)] + Z(d\varphi_i) - \sum_{z \in \Gamma_1(u_i)} (k_z - 1) - \sum_{z \in \Gamma_0(u_i)} k_z \right) \\
& - \#\Gamma_0(u^\infty) - 2\#\Gamma_1(u^\infty) + 2 \sum_{i=1}^L \sum_{\zeta \in \Gamma(v_i)} \sum_{z \in \varphi_i^{-1}(\zeta)} k_z m_\zeta \\
& = 2(L-1) + \sum_{i=1}^L \left( k_i [\text{ind}(v_i) + \#\Gamma_0(v_i)] + Z(d\varphi_i) \right. \\
& \quad + \sum_{\zeta \in \Gamma_0(v_i)} \sum_{z \in \varphi_i^{-1}(\zeta)} (2k_z m_\zeta - k_z - 1) \\
& \quad \left. + \sum_{\zeta \in \Gamma_1(v_i)} \sum_{z \in \varphi_i^{-1}(\zeta)} (2k_z m_\zeta - (k_z - 1) - 2) \right).
\end{aligned}$$

□

The next step is to combine the above lemma with the lower bounds on indices arising from Lemmas 6.6 and 6.11 and some information from intersection theory.

**Lemma 6.19.** *Assume  $(u^\infty, \tau_\infty) \in \overline{\mathcal{M}}^{\text{nice}}(\{\widehat{J}_\tau\}; H; \mathbf{m})$  and that  $u^\infty$  has nodes. Then there is exactly one node, there are no ghost bubbles, and the main level has exactly two connected components  $u_1$  and  $u_2$ , each somewhere injective with all asymptotic orbits simply covered and satisfying  $\text{ind}(u_i) + \#\Gamma_0(u_i) = 0$  for  $i = 1, 2$ .*

*Proof.* If  $u^\infty$  has nodes, then Lemma 6.18 applies to each of its nonconstant maximal non-nodal subbuildings (see §2.2), and the right hand side of this relation is nonnegative due to (6.3). The sum of the left hand sides over all these subbuildings is meanwhile at most 2 due to Lemma 6.12. Proposition 2.6 thus implies that there are no ghost bubbles, there is exactly one node connecting two maximal non-nodal subbuildings, and for both of these the expression on the right hand side in Lemma 6.18 vanishes. This implies that each has exactly one component  $u_i = v_i \circ \varphi_i$  in the main level, where the underlying simple curve  $v_i$  satisfies  $\text{ind}(v_i) + \#\Gamma_0(v_i) = 0$  and has  $m_\zeta = 1$  for all  $\zeta \in \Gamma(v_i)$ . Moreover,  $Z(d\varphi_i) = 0$  and  $k_z = 1$  for all  $z \in \Gamma(u_i)$ , hence the Riemann-Hurwitz formula (6.5) implies  $k_i = 1$ , i.e.  $u_i$  is somewhere injective and  $u_i = v_i$ . □

Here is a more complete inventory of the consequences of Lemma 6.18.

**Lemma 6.20.** *If  $(u^\infty, \tau_\infty) \in \overline{\mathcal{M}}^{\text{nice}}(\{\widehat{J}_\tau\}; H; \mathbf{m})$ , then the following constraints hold:*

- *The number of connected components in the main level is at most 2;*
- *The asymptotic orbits of all the curves  $v_i$  are either simply or doubly covered;*
- *$\text{ind}(v_i) + \#\Gamma_0(v_i) = 0$  or 2 for each  $i$ ;*
- *All punctures  $z \in \Gamma(u_i)$  have  $k_z \leq 2$ , and furthermore  $k_z m_{\varphi_i(z)} \leq 2$ .*

Moreover:

- (1) If any  $v_i$  has  $\text{ind}(v_i) + \#\Gamma_0(v_i) = 2$ , then  $L = 1$  and  $u_1$  is somewhere injective (i.e.  $u_1 = v_1$ ).
- (2) If all the  $v_i$  have  $\text{ind}(v_i) + \#\Gamma_0(v_i) = 0$ , then:
  - (a) If any of the  $v_i$  has a doubly covered orbit, then it is the only doubly covered orbit,  $L = 1$ , and  $u_1$  is somewhere injective (i.e.  $u_1 = v_1$ ).
  - (b) If on the other hand  $m_\zeta = 1$  for all  $\zeta \in \Gamma(v_i)$ , we consider two cases:
    - (i) If  $L = 1$ , let  $\ell \geq 0$  denote the number of punctures  $z \in \Gamma(u_1)$  at which  $k_z = 2$ : then  $\ell \leq 2$  and all other punctures have  $k_z = 1$ . Moreover,  $u_1$  is somewhere injective if  $\ell = 0$ , and otherwise  $\ell + Z(d\varphi_1) = 2$  and  $k_1 = 2$ .
    - (ii) If  $L = 2$ , then both components in the main level are somewhere injective, all their asymptotic orbits are simply covered and  $\text{ind}(u_i) + \#\Gamma_0(u_i) = 0$  for  $i = 1, 2$ .

In particular, the components  $u_i$  in the main level are somewhere injective except possibly in case 2(b)i.

*Proof.* If  $u^\infty$  has any nodes then Lemma 6.19 applies and produces a result consistent with case 2(b)ii. Let us therefore assume there are no nodes, so that the relation in Lemma 6.18 applies to  $u^\infty$  directly, and its left hand side is at most 2 by Lemma 6.12. The first three bullet points are then immediate from the lemma since  $\text{ind}(v_i) + \#\Gamma_0(v_i) \geq 0$  for all  $i$ . For the fourth bullet point, we also see an immediate contradiction if  $k_z \geq 4$  for some  $z \in \Gamma(u_i)$ , so suppose  $k_z = 3$ , with  $\zeta = \varphi_i(z) \in \Gamma(v_i)$ . Then  $m_\zeta$  must be 1 and  $k_z$  must also be 1 for all other  $z \in \Gamma(u_i)$ , and  $Z(d\varphi_i) = 0$ , but then (6.5) gives

$$Z(d\varphi_i) + \sum_{z \in \Gamma(u_i)} (k_z - 1) = 2 = 2(k_i - 1),$$

hence  $k_i = 2$  and there cannot be a branch point of order 3. We therefore have both  $k_z \leq 2$  and  $m_\zeta \leq 2$  for all punctures; if ever  $k_z = m_\zeta = 2$ , then Lemma 6.18 provides another immediate contradiction, so this completes the proof of the fourth bullet point.

Cases 1, 2a and 2(b)ii follow from Lemma 6.18 via similar arguments: in each case, somewhere injectivity follows from the Riemann-Hurwitz formula (6.5) after observing that  $Z(d\varphi_i)$  and all the  $k_z - 1$  must vanish.

We now consider case 2(b)i. By hypothesis, we have  $L = 1$ ,  $\text{ind}(v_1) + \#\Gamma_0(v_1) = 0$  and  $m_\zeta = 1$  for each  $\zeta \in \Gamma(v_1)$ , and taking account of Lemma 6.12, the identity in Lemma 6.18 now simplifies to

$$2 \geq \text{ind}(u^\infty) + \#\Gamma_0(u^\infty) + 2\#\Gamma^2(u^\infty) = Z(d\varphi_1) + \sum_{z \in \Gamma(u_1)} (k_z - 1),$$

which equals  $2(k_1 - 1)$  by (6.5). The stated conclusions follow immediately.  $\square$

**6.3.5. Intersection numbers.** In the present setting, Lemma 2.7 provides an easy method for computing Siefring intersection numbers since, according to Lemma 4.12, all the orbits  $\gamma$  appearing as positive asymptotic orbits satisfy  $\alpha_-(\gamma) = 0$  in the  $S^1$ -invariant trivialization. This implies that if  $u$  and  $u'$  each denote any of  $u^\infty$ ,  $u_i$  or  $v_i$ , we have

$$(6.8) \quad u * u' = u \bullet_{\Phi_0} u',$$

with  $\Phi_0$  denoting the  $S^1$ -invariant trivialization and  $\bullet_{\Phi_0}$  denoting the relative intersection pairing described in §2.3.

**Lemma 6.21.**  $\sum_{j,k=1}^L u_j * u_k = u^\infty * u^\infty.$

*Proof.* By Lemma 6.16, all the components in upper levels of  $u^\infty$  are covers of trivial cylinders and gradient flow cylinders. Any two curves  $u$  and  $u'$  of this type satisfy  $u \bullet_{\Phi_0} u' = 0$ , as one can define the trivialization  $\Phi_0$  globally over  $\widetilde{M}_\Sigma^+$  and then make  $u'$  disjoint from  $u$  by a global perturbation of  $u'$  in the direction of  $\Phi_0$ . The formula thus follows by computing  $u^\infty \bullet_{\Phi_0} u^\infty$  as a double sum over all components in all levels and applying (6.8).  $\square$

Let us assume from now on that

$$(u^\infty, \tau_\infty) \in \overline{\mathcal{M}}^{\text{nice}}(\{\widehat{J}_\tau\}; H; \mathbf{m}).$$

We can now give a complete description of  $u^\infty$  in the case  $u^\infty * u^\infty = -1$ , which by Lemma 6.12 means  $\text{ind}(u_\infty) \in \{-1, 0\}$ ,  $\#\Gamma_0(u^\infty) \in \{0, 1\}$  and all asymptotic orbits of  $u^\infty$  are simply covered.

**Lemma 6.22.** *If  $u^\infty * u^\infty = -1$ , then  $u^\infty$  is either a smooth nicely embedded curve or a building with two nontrivial levels, where the main level  $u_1$  is a connected nicely embedded curve with  $\text{ind}(u_1) = u_1 * u_1 = -1$  and simply covered asymptotic orbits, and the upper level is a disjoint union of trivial cylinders with a single gradient flow cylinder from  $\mathcal{M}_1^{\mathbb{F}^+}(J_+)$ .*

*Proof.* Since Lemma 6.12 implies  $\text{ind}(u^\infty) + \#\Gamma_0(u^\infty) = \#\Gamma^m(u^\infty) = 0$  for all  $m \geq 2$ , Lemma 6.18 then implies  $L = 1$ ,  $\text{ind}(v_1) + \#\Gamma_0(v_1) = Z(d\varphi_1) = 0$  and  $k_z = m_\zeta = 1$  for all punctures  $\zeta$  and  $z$ . Thus by the Riemann-Hurwitz formula (6.5),  $u_1 = v_1$  and the main level is described by Case 2(b)i of Lemma 6.20 with  $\ell = 0$ . Lemma 6.21 implies  $u_1 * u_1 = -1$ , and  $\text{ind}(u_1) + \#\Gamma_0(u_1) = 0$  implies via (2.11) that  $c_N(u_1) = -1$ , so by the adjunction inequality (2.10),  $\delta(u_1) = \delta_\infty(u_1) = 0$ , hence  $u_1$  is nicely embedded. The fact that all asymptotic orbits of both  $u_1$  and  $u^\infty$  are simply covered and  $u^\infty$  has arithmetic genus 0 implies moreover that all components in upper levels are also somewhere injective. Adding up the indices across levels, this eliminates all possibilities other than what was stated.  $\square$

Since  $u^\infty * u^\infty$  is always either  $-1$  or  $0$  by Lemma 6.12, we shall consider the case  $u^\infty * u^\infty = 0$  from now on.

**Lemma 6.23.** *If  $u^\infty * u^\infty = 0$ , then the main level consists of either a single nicely embedded curve  $u_1$  or two distinct nicely embedded curves  $u_1$  and  $u_2$  that intersect each other transversely at a node and nowhere else. Moreover, if the main level is a single curve  $u_1$ , then all its asymptotic orbits are simply covered if  $\text{ind}(u_1) + \#\Gamma_0(u_1) = 2$ , and exactly one of them is doubly covered if  $\text{ind}(u_1) + \#\Gamma_0(u_1) = 0$ .*

*Proof.* Let us first rule out the possibility of a single doubly covered component  $u_1 = v_1 \circ \varphi_1$  from case 2(b)i of Lemma 6.20. If this scenario occurs, then we know  $\text{ind}(v_1) + \#\Gamma_0(v_1) = 0$  and all the asymptotic orbits of  $v_1$  are simply covered. Equation (2.11) thus gives  $c_N(v_1) = -1$ , and Lemma 2.8 gives  $\bar{\sigma}(v) - \#\Gamma(v) = 0$ , so by the adjunction formula (2.9),

$$v_1 * v_1 = 2[\delta(v) + \delta_\infty(v)] - 1.$$

In particular, this is an odd integer. But using (6.8) and Lemma 6.21, we also have

$$0 = u^\infty * u^\infty = u_1 * u_1 = u_1 \bullet_{\Phi_0} u_1 = 4(v_1 \bullet_{\Phi_0} v_1) = 4(v_1 * v_1)$$

since  $u_1$  is a double cover of  $v_1$ , so this implies that  $0$  is an odd number and thus rules out multiply covered components in the main level.

Exactly the same contradiction occurs if we consider Case 2(b)ii of Lemma 6.20 assuming  $u_1$  and  $u_2$  are the same curve up to parametrization. Indeed,  $u_i * u_i$  is then an odd integer for  $i = 1, 2$  due to the adjunction formula

$$(6.9) \quad u_i * u_i = 2[\delta(u_i) + \delta_\infty(u_i)] - 1,$$

and Lemma 6.21 gives

$$(6.10) \quad 0 = u^\infty * u^\infty = u_1 * u_1 + u_2 * u_2 + 2(u_1 * u_2),$$

which reduces to  $0 = 4(u_1 * u_1)$  and again implies that 0 is an odd number.

Next consider case 2(b)ii when  $u_1 \neq u_2$ . Combining (6.9) and (6.10) in this case implies

$$0 = 2 \sum_{i=1}^2 [\delta(u_i) + \delta_\infty(u_i)] + 2(u_1 * u_2 - 1).$$

Since  $\text{ind}(u_1)$  and  $\text{ind}(u_2)$  are both either  $-1$  or  $0$ , genericity allows us via Lemma 6.10 to assume  $\delta_\infty(u_i) = 0$  for  $i = 1, 2$  and moreover that  $u_1 * u_2$  is the (algebraic) count of *actual* intersections between  $u_1$  and  $u_2$ , with no additional asymptotic contributions. Let us therefore rewrite the above relation as

$$1 = \delta(u_1) + \delta(u_2) + u_1 \bullet u_2,$$

with  $u_1 \bullet u_2 \geq 0$  denoting the count of actual intersections. If  $u_1$  and  $u_2$  are connected at a node, then they necessarily intersect, implying  $u_1 \bullet u_2 = 1$  and  $\delta(u_1) = \delta(u_2) = 0$ , hence both are embedded and they have only one intersection, which is transverse and occurs at the node. Equation (6.9) then implies that both satisfy  $u_i * u_i = -1$ , so they are nicely embedded. If on the other hand there is no node, then the above relation between  $\delta(u_1)$ ,  $\delta(u_2)$  and  $u_1 \bullet u_2$  cannot hold, as all three terms must be 0. To see this, recall that the assumption  $(u^\infty, \tau_\infty) \in \overline{\mathcal{M}}^{\text{nice}}(\{\widehat{J}_\tau\}; H; \mathbf{m})$  means that there exist sequences

$$\tau_\nu \rightarrow \tau_\infty \quad \text{and} \quad u^\nu \rightarrow u^\infty \quad \text{as } \nu \rightarrow \infty$$

where  $\tau_\nu \in [0, 1]$  and  $u^\nu \in \mathcal{M}^{\text{nice}}(\widehat{J}_{\tau_\nu}; H; \mathbf{m})$ , so in particular all the  $u^\nu$  are embedded. But if any of the three terms above were positive, then there would be at least one isolated double point or critical point of  $u_1$  or  $u_2$ , or an isolated intersection between them, and any of these scenarios would give rise to an isolated singularity of the curves  $u^\nu$  for sufficiently large  $\nu$  due to local positivity of intersections. This is a contradiction.

Finally, we show that in all remaining cases of Lemma 6.20, the single somewhere injective curve  $u_1$  in the main level is nicely embedded. Lemma 6.21 implies  $u_1 * u_1 = 0$ , so we just need to show  $\delta(u_1) = \delta_\infty(u_1) = 0$ . Since  $u_1$  cannot have any nodal points in this case, local positivity of intersections implies  $\delta(u_1) = 0$ , as a singularity in  $u_1$  would again be seen by the embedded curves  $u^\nu$  for  $\nu$  sufficiently large. Thus we only still need to prove  $\delta_\infty(u_1) = 0$ . This follows from genericity (Lemma 6.10) if  $\text{ind}(u_1) \leq 0$ , which takes care of cases 2a and 2(b)i in Lemma 6.20. These are the cases with  $\text{ind}(u_1) + \#\Gamma(u_1) = 0$ , hence  $c_N(u_1) = -1$  by (2.11), and the adjunction formula then gives

$$0 = -1 + [\bar{\sigma}(u_1) - \#\Gamma(u_1)],$$

so by Lemma 2.8,  $u_1$  has exactly one doubly covered asymptotic orbit and the rest are simply covered. We are now left only with case 1, with  $\text{ind}(u_1) + \#\Gamma_0(u_1) = 2$ . Now (2.11) implies  $c_N(u_1) = 0$ , so the adjunction formula (2.9) becomes

$$0 = 2\delta_\infty(u_1) + [\bar{\sigma}(u_1) - \#\Gamma(u_1)]$$



and thus implies both  $\delta_\infty(u_1) = 0$  and  $\bar{\sigma}(u_1) - \#\Gamma(u_1) = 0$ . By Lemma 2.8, the latter implies that all asymptotic orbits of  $u_1$  are simply covered.  $\square$

6.3.6. *Conclusion of the compactness proof.* The preceding lemmas establish a complete picture of all the possible main levels of the building  $u^\infty$ . To finish the proof of Propositions 6.13 and 6.14, we only need to describe the possible multiple covers of leaves of  $\mathcal{F}_+$  that can occur in the upper levels. These components are highly constrained for the following reasons:

- (1) Most asymptotic orbits of the main level are simply covered, with at most one exception which is doubly covered and occurs only if the main level is a single curve  $u_1$  with  $u_1 * u_1 = \text{ind}(u_1) + \#\Gamma_0(u_1) = 0$ ;
- (2) The building has arithmetic genus zero: since the possibly nodal curve forming the main level is always connected, this implies that no curve in any upper level can have more than one negative puncture;
- (3) All curves in upper levels are covers of cylinders.

Let us first consider the case where  $u^\infty$  has nodes: then Lemmas 6.20 and 6.23 imply that there is only one node, which occurs in the main level, where it connects two nicely embedded curves whose asymptotic orbits are all simply covered. As observed above, the genus condition implies that no curve in any upper level can have more than one negative puncture, and since they are all covers of cylinders, the fact that orbits are simply covered means that no curves in upper levels can be multiple covers. It follows that the upper levels consist entirely of trivial cylinders or gradient flow cylinders, where each of the latter contributes 1 to the total index of  $u^\infty$ . The two curves in the main level each have index either  $-1$  or  $0$ , but since they are distinct, they cannot both have index  $-1$  due to genericity (Lemmas 6.6 and 6.11). This completes the description of all possible nodal buildings.

In the absence of nodes, the main level is a single nicely embedded curve  $u_1$ , and the above description of the upper levels still applies whenever the asymptotic orbits of  $u_1$  are all simple: outside of the case  $u^\infty * u^\infty = -1$ , which was dealt with in Lemma 6.22, this is true if and only if  $\text{ind}(u_1) + \#\Gamma_0(u_1) = 2$ . If  $\text{ind}(u_1) + \#\Gamma_0(u_1) = 0$ , then exactly one asymptotic orbit of  $u_1$  is doubly covered, which allows for a limited range of multiple covers to appear in the upper levels: indeed, there can be doubly covered unbranched cylinders (which are either trivial or cover gradient flow cylinders and thus have index 1), and exactly one branched double cover with two positive punctures and one negative puncture. Suppose  $u$  is such a branched double cover, and the underlying simple curve is  $v$ . From Lemma 4.9, the possible indices of  $u$  are as follows:

- If  $v = \mathbb{R} \times \gamma$  with  $\gamma$  elliptic, then  $\text{ind}(u) = 2$ ;
- If  $v = \mathbb{R} \times \gamma$  with  $\gamma$  hyperbolic, then  $\text{ind}(u) = 1$ ;
- If  $v$  is a gradient flow cylinder, then  $\text{ind}(u) = 3$ .

The buildings enumerated in Propositions 6.13 and 6.14 are thus found by putting together all possible combinations of these ingredients that add up to the correct index.

As a particular consequence, the above arguments show that the only holomorphic buildings appearing in  $\mathcal{M}_0^{\text{nice}}(\widehat{\mathcal{J}}; H; \mathbf{m})$  and  $\mathcal{M}_{-1}^{\text{nice}}(\{\widehat{\mathcal{J}}_\tau\}; H; \mathbf{m})$  are smooth curves (i.e. with no nodes and only one level), hence these spaces are compact. Note that by Lemma 6.11, none of the curves in those spaces are confined to the non-generic domain  $\widehat{\mathcal{N}}_-(\partial E)$ , hence our genericity assumptions ensure that  $\mathcal{M}_0^{\text{nice}}(\widehat{\mathcal{J}}; H; \mathbf{m})$  and  $\mathcal{M}_{-1}^{\text{nice}}(\{\widehat{\mathcal{J}}_\tau\}; H; \mathbf{m})$  are also both 0-dimensional manifolds and therefore finite sets. Lemma 6.6 implies moreover that for any two distinct elements  $(u, \tau)$  and  $(u', \tau') \in \mathcal{M}_{-1}^{\text{nice}}(\{\widehat{\mathcal{J}}_\tau\}; H; \mathbf{m})$ , we have  $\tau \neq \tau'$ , and we define  $I^{\text{sing}}$  as the

finite set of values  $\tau \in [0, 1]$  for which such curves exist; this set cannot include 0 or 1 since both  $\hat{J}_0$  and  $\hat{J}_1$  are assumed generic. For any  $\tau \notin I^{\text{sing}}$ , the non-existence of index  $-1$  curves rules out all of the scenarios listed in Proposition 6.14, leaving only the list in Proposition 6.13. The proof of both propositions is now complete.

**6.4. Holomorphic foliations on the completed filling.** In this section we prove Propositions 6.3 and 6.4. For both results, the main step will be to show that the holomorphic pages living in  $\hat{\mathcal{N}}_-(\partial E)$  extend to the rest of  $\widehat{W}$  as a foliation with finitely many singularities at the nodal points, and that this foliation varies smoothly with the parameter  $\tau$ . We will then use the foliation to define suitable smooth structures on the interiors of  $\widehat{\mathcal{M}}^{\mathcal{F}}(\hat{J})$  and  $\widehat{\mathcal{M}}^{\mathcal{F}}(\{\hat{J}_\tau\})$ . It's worth recalling briefly the type of argument that was used for this step in [Wen10c]: in that simpler setting, all main level curves in the moduli space either have index 2 or are nodal curves with components of index 0, all of them satisfying the automatic transversality criterion of [Wen10b]. The foliation then arises easily from a combination of the implicit function theorem and compactness, showing that the index 2 curves fill an open and closed subset of  $\widehat{W}$  in the complement of the images of finitely many nodal curves—the latter being a subset of codimension 2—and automatic transversality guarantees that these families of curves always persist under changes in  $\tau$ . The crucial difference in the present setting is that in the compactness statements of Propositions 6.13 and 6.14, not all degenerations have codimension at least 2; in particular one can imagine the above argument failing as the index 2 curves run into a “wall” of codimension 1 formed by index 1 curves. Such walls exist in  $\widehat{\mathcal{M}}^{\mathcal{F}}(\hat{J})$  and  $\widehat{\mathcal{M}}^{\mathcal{F}}(\{\hat{J}_\tau\})$ , but it would be more accurate to call them *seams*: since they always include a gradient flow cylinder in an upper level, they come in canceling pairs, with the consequence that every such degeneration can be glued back together using a different gradient cylinder in order to “cross the wall”.

For  $i \in \{1, 2\}$ , define

$$\widehat{\mathcal{M}}_i^{\mathcal{F}}(\hat{J}_\tau) \subset \widehat{\mathcal{M}}^{\mathcal{F}}(\hat{J}_\tau)$$

to be the subset of all equivalence classes of buildings whose main levels are connected smooth curves in  $\mathcal{M}_i^{\text{nice}}(\hat{J}_\tau; H; \mathbf{m})$ . For  $i \in \{-1, 0\}$ , we define  $\widehat{\mathcal{M}}_i^{\mathcal{F}}(\hat{J}_\tau)$  similarly but allow it additionally to contain equivalence classes of buildings whose main levels are nodal curves with two connected components, one belonging to  $\mathcal{M}_0^{\text{nice}}(\hat{J}_\tau; H; \mathbf{m})$  and the other to  $\mathcal{M}_i^{\text{nice}}(\hat{J}_\tau; H; \mathbf{m})$ . The subsets  $\widehat{\mathcal{M}}_i^{\mathcal{F}}(\{\hat{J}_\tau\}) \subset \widehat{\mathcal{M}}^{\mathcal{F}}(\{\hat{J}_\tau\})$  and  $\widehat{\mathcal{M}}_i^{\mathcal{F}}(\hat{J}) \subset \widehat{\mathcal{M}}^{\mathcal{F}}(\hat{J})$  are defined similarly.

**Lemma 6.24.** *Suppose  $([u_0], \tau_0) \in \widehat{\mathcal{M}}_2^{\mathcal{F}}(\{\hat{J}_\tau\})$ . Then there exist neighborhoods  $\mathcal{U} \subset \widehat{\mathcal{M}}^{\mathcal{F}}(\{\hat{J}_\tau\})$  of  $([u_0], \tau_0)$  and  $\mathcal{V} \subset [0, 1]$  of  $\tau_0$  such that  $\mathcal{U} \subset \widehat{\mathcal{M}}_2^{\mathcal{F}}(\{\hat{J}_\tau\})$  and for every  $\tau \in \mathcal{V}$ ,*

$$\mathcal{U}_\tau := \mathcal{U} \cap \widehat{\mathcal{M}}^{\mathcal{F}}(\hat{J}_\tau)$$

*is a contractible open subset of  $\widehat{\mathcal{M}}^{\mathcal{F}}(\hat{J}_\tau)$  in which the main levels define a smooth 2-parameter family of embedded curves with disjoint images that foliate an open subset of  $\widehat{W}$ .*

*Proof.* This is essentially a standard application of the implicit function theorem for nicely embedded index 2 curves, see [Wen05, Theorem 4.5.42] or [Wen20, Theorem 3.26]. It derives mainly from two crucial facts: (1) curves in  $\mathcal{M}_2^{\text{nice}}(\hat{J}_\tau; H; \mathbf{m})$  satisfy the automatic transversality criterion of [Wen10b], hence genericity is not required and the moduli space perturbs smoothly with  $\tau$ , and (2) tangent spaces  $T_u \mathcal{M}_2^{\text{nice}}(\hat{J}_\tau; H; \mathbf{m})$  are equivalent to spaces of holomorphic sections of the normal bundle along  $u$ , and these sections are always nowhere zero.  $\square$

**Lemma 6.25.** *Suppose  $([u_0], \tau_0) \in \widehat{\mathcal{M}}_1^{\mathcal{F}}(\{\widehat{J}_\tau\})$ . Then there exist neighborhoods  $\mathcal{U} \subset \widehat{\mathcal{M}}^{\mathcal{F}}(\{\widehat{J}_\tau\})$  of  $([u_0], \tau_0)$  and  $\mathcal{V} \subset [0, 1]$  of  $\tau_0$  and a homeomorphism*

$$\Psi : (-1, 1)^2 \times \mathcal{V} \rightarrow \mathcal{U}$$

such that for all  $(x, y, \tau) \in (-1, 1)^2 \times \mathcal{V}$ ,

$$\Psi(0, y, \tau) \in \widehat{\mathcal{M}}_1^{\mathcal{F}}(\widehat{J}_\tau) \quad \text{and} \quad \Psi(x, y, \tau) \in \widehat{\mathcal{M}}_2^{\mathcal{F}}(\widehat{J}_\tau) \quad \text{if } x \neq 0.$$

Moreover, for each  $\tau \in \mathcal{V}$ , the embedded curves that constitute the main levels of  $\Psi(x, y, \tau)$  for  $(x, y) \in (-1, 1)^2$  are disjoint from each other and form the leaves of a smooth foliation on an open subset of  $\widehat{W}$ .

*Proof.* The 2-parameter family  $(y, \tau) \mapsto \Psi(0, y, \tau) \in \widehat{\mathcal{M}}_1^{\mathcal{F}}(\widehat{J}_\tau)$  arises for reasons similar to the proof of Lemma 6.24: curves in  $\mathcal{M}_1^{\text{nice}}(\widehat{J}_\tau; H; \mathbf{m})$  satisfy the automatic transversality criterion of [Wen10b] and are thus regular for every  $\tau$ . Indeed, the criterion is satisfied because by Lemma 6.12, any  $u \in \mathcal{M}_1^{\text{nice}}(\widehat{J}_\tau; H; \mathbf{m})$  has only simply covered asymptotic orbits and exactly one of them is hyperbolic. Moreover,  $u * u = 0$ , implying that for any fixed  $\tau \in \mathcal{V}$ , the main levels of the 1-parameter family  $y \mapsto \Psi(0, y, \tau)$  are all disjoint and thus foliate a smoothly embedded hypersurface in  $\widehat{W}$ .

We claim that gluing can be used to extend this foliation to a neighborhood of the hypersurface. The crucial detail here is that each of the equivalence classes  $[u] := \Psi(0, y, \tau)$  is represented by exactly two buildings  $u_+$  and  $u_-$  whose upper levels have non-identical images: indeed, since all asymptotic orbits for the buildings representing elements of  $\widehat{\mathcal{M}}^{\mathcal{F}^+}(J_+)$  are simply covered and elliptic, the same is true for all elements of  $\widehat{\mathcal{M}}^{\mathcal{F}}(\{\widehat{J}_\tau\})$ , so that the upper levels of  $\Psi(0, y, \tau)$  must always be unions of trivial cylinders with a gradient flow cylinder connecting the hyperbolic orbit to an elliptic orbit. There are always exactly two choices of this gradient flow cylinder—they form a *canceling pair* in the sense of Lemma 6.1. By the same argument as in Lemma 6.21, both of the buildings  $u_\pm$  satisfy

$$(6.11) \quad u_+ * u_+ = u_- * u_- = u_+ * u_- = 0,$$

and observe that the gradient flow cylinders in their upper levels are also automatically regular. We can therefore glue both buildings to obtain a pair of 1-parameter families of smooth and nicely embedded index 2 curves, which we define to be  $\Psi(x, y, \tau)$  for  $x > 0$  and  $x < 0$  respectively. Each of these two families satisfies the same implicit function theorem that was used in Lemma 6.24, hence they each foliate open subsets of  $\widehat{W}$ . Moreover, the homotopy invariance of the intersection pairing implies via (6.11) that if  $u$  and  $u'$  denote the main levels of  $\Psi(x, y, \tau)$  and  $\Psi(x', y', \tau)$  with  $x$  and  $x'$  both nonzero, then  $u * u' = 0$ , hence the two open subsets foliated by the two families are disjoint, and for similar reasons, both are disjoint from the main levels of the curves  $\Psi(0, y, \tau)$  but contain them in their closures. This shows that the main levels of the 2-parameter family  $(x, y) \mapsto \Psi(x, y, \tau)$  foliate an open subset of  $\widehat{W}$  for each  $\tau$  sufficiently close to 0.  $\square$

The preceding pair of lemmas shows that  $\widehat{\mathcal{M}}_2^{\mathcal{F}}(\{\widehat{J}_\tau\}) \cup \widehat{\mathcal{M}}_1^{\mathcal{F}}(\{\widehat{J}_\tau\})$  is an open subset of  $\widehat{\mathcal{M}}^{\mathcal{F}}(\{\widehat{J}_\tau\})$  and has the topology of a 3-dimensional manifold, and for each  $\tau \in [0, 1]$ ,  $\widehat{\mathcal{M}}_2^{\mathcal{F}}(\widehat{J}_\tau) \cup \widehat{\mathcal{M}}_1^{\mathcal{F}}(\widehat{J}_\tau) \subset \widehat{\mathcal{M}}^{\mathcal{F}}(\widehat{J}_\tau)$  is similarly open and is a 2-dimensional manifold. Denote the closure of  $\widehat{\mathcal{M}}_2^{\mathcal{F}}(\{\widehat{J}_\tau\})$  in  $\widehat{\mathcal{M}}^{\mathcal{F}}(\{\widehat{J}_\tau\}) \setminus (\widehat{\mathcal{M}}^{\mathcal{F}^+}(J_+) \times [0, 1])$  by

$$\widehat{\mathcal{M}}_{\text{nice}}^{\mathcal{F}}(\{\widehat{J}_\tau\}) \subset \widehat{\mathcal{M}}^{\mathcal{F}}(\{\widehat{J}_\tau\}) \setminus (\widehat{\mathcal{M}}^{\mathcal{F}^+}(J_+) \times [0, 1]),$$

and define

$$\widehat{\mathcal{M}}_{\text{nice}}^{\mathcal{F}}(\widehat{\mathcal{J}}_{\tau}) := \left\{ u \in \widehat{\mathcal{M}}^{\mathcal{F}}(\widehat{\mathcal{J}}_{\tau}) \mid (u, \tau) \in \widehat{\mathcal{M}}_{\text{nice}}^{\mathcal{F}}(\{\widehat{\mathcal{J}}_{\tau}\}) \right\}$$

for each  $\tau \in [0, 1]$ .

**Lemma 6.26.** *The closure  $\widehat{\mathcal{M}}_{\text{nice}}^{\mathcal{F}}(\{\widehat{\mathcal{J}}_{\tau}\})$  is the union of the sets  $\widehat{\mathcal{M}}_i^{\mathcal{F}}(\{\widehat{\mathcal{J}}_{\tau}\})$  for all  $i \in \{-1, 0, 1, 2\}$ . Moreover, the  $\widehat{\mathcal{M}}_i^{\mathcal{F}}(\{\widehat{\mathcal{J}}_{\tau}\})$  are smooth manifolds of dimension  $i + 1$ , and for  $i \in \{-1, 0\}$  they decompose into the following subsets characterized by the main level  $u_0$  of an equivalence class of buildings  $[u] \in \widehat{\mathcal{M}}_i^{\mathcal{F}}(\{\widehat{\mathcal{J}}_{\tau}\})$ :*

- $[u] \in \widehat{\mathcal{M}}_{\text{reg}, i}^{\mathcal{F}}(\{\widehat{\mathcal{J}}_{\tau}\}) := \widehat{\mathcal{M}}_i^{\mathcal{F}}(\{\widehat{\mathcal{J}}_{\tau}\}) \cap \widehat{\mathcal{M}}_{\text{reg}}^{\mathcal{F}}(\{\widehat{\mathcal{J}}_{\tau}\})$  if and only if  $u_0$  is a smooth nicely embedded curve with  $\text{ind}(u_0) = i$  and all asymptotic orbits simply covered, with  $2 - i$  of them hyperbolic;
- $[u] \in \widehat{\mathcal{M}}_{\text{sing}, i}^{\mathcal{F}}(\{\widehat{\mathcal{J}}_{\tau}\}) := \widehat{\mathcal{M}}_i^{\mathcal{F}}(\{\widehat{\mathcal{J}}_{\tau}\}) \cap \widehat{\mathcal{M}}_{\text{sing}}^{\mathcal{F}}(\{\widehat{\mathcal{J}}_{\tau}\})$  if and only if  $u_0$  is a nodal curve with two nicely embedded connected components  $v$  and  $v'$ , where  $\text{ind}(v) = 0$  with all asymptotic orbits simply covered and elliptic, while  $\text{ind}(v') = i$  with all asymptotic orbits simply covered and  $-i$  of them hyperbolic;
- $[u] \in \widehat{\mathcal{M}}_{\text{exot}, i}^{\mathcal{F}}(\{\widehat{\mathcal{J}}_{\tau}\}) := \widehat{\mathcal{M}}_i^{\mathcal{F}}(\{\widehat{\mathcal{J}}_{\tau}\}) \cap \widehat{\mathcal{M}}_{\text{exot}}^{\mathcal{F}}(\{\widehat{\mathcal{J}}_{\tau}\})$  if and only if  $u_0$  is a smooth nicely embedded curve with  $\text{ind}(u_0) = i$  and one asymptotic orbit doubly covered, the rest simply covered, and  $-i$  of them hyperbolic.

*Proof.* This is essentially a repackaging of the main compactness results from §6.3, i.e. Propositions 6.13 and 6.14. The statement about the dimension of  $\widehat{\mathcal{M}}_i^{\mathcal{F}}(\{\widehat{\mathcal{J}}_{\tau}\})$  for  $i \in \{-1, 0\}$  follows directly from the implicit function theorem since  $\{\widehat{\mathcal{J}}_{\tau}\}$  is generic in the interior of  $W$  and all of these curves must intersect that interior due to Lemma 6.11.  $\square$

**Lemma 6.27.** *We have*

$$\widehat{\mathcal{M}}_{\text{nice}}^{\mathcal{F}}(\{\widehat{\mathcal{J}}_{\tau}\}) = \widehat{\mathcal{M}}^{\mathcal{F}}(\{\widehat{\mathcal{J}}_{\tau}\}) \setminus \left( \widehat{\mathcal{M}}^{\mathcal{F}+}(J_+) \times [0, 1] \right),$$

and for each  $\tau \in [0, 1]$ , any two buildings  $u, u'$  representing equivalence classes in  $\widehat{\mathcal{M}}^{\mathcal{F}}(\widehat{\mathcal{J}}_{\tau})$  satisfy  $u * u' = 0$ .

*Proof.* By construction,  $\widehat{\mathcal{M}}_{\text{nice}}^{\mathcal{F}}(\{\widehat{\mathcal{J}}_{\tau}\})$  is closed in  $\widehat{\mathcal{M}}^{\mathcal{F}}(\{\widehat{\mathcal{J}}_{\tau}\}) \setminus (\widehat{\mathcal{M}}^{\mathcal{F}+}(J_+) \times [0, 1])$ ; we claim that it is also open. We've already seen that  $\widehat{\mathcal{M}}_2^{\mathcal{F}}(\{\widehat{\mathcal{J}}_{\tau}\}) \cup \widehat{\mathcal{M}}_1^{\mathcal{F}}(\{\widehat{\mathcal{J}}_{\tau}\})$  is open due to Lemmas 6.24 and 6.25, so it suffices to show that any  $([u], \tau) \in \widehat{\mathcal{M}}_i^{\mathcal{F}}(\{\widehat{\mathcal{J}}_{\tau}\})$  for  $i \in \{-1, 0\}$  has a neighborhood in  $\widehat{\mathcal{M}}^{\mathcal{F}}(\{\widehat{\mathcal{J}}_{\tau}\})$  contained in  $\widehat{\mathcal{M}}_{\text{nice}}^{\mathcal{F}}(\{\widehat{\mathcal{J}}_{\tau}\})$ . Let  $u$  denote a holomorphic building representing such an element. A neighborhood of  $([u], \tau)$  will consist of all nearby elements of the  $(i + 1)$ -dimensional moduli space described in Lemma 6.26, plus any other equivalence classes represented by buildings with fewer levels (e.g. smooth curves) that are close to converging to  $u$  or one of its equivalent buildings in the SFT-topology. Lemma 6.26 describes the possible main levels of  $u$ , and the upper levels are allowed to consist of anything that produces arithmetic genus zero and the right collection of asymptotic orbits (all of them simply covered) at the positive ends. This allows for exactly the same range of possibilities as seen in Propositions 6.13 and 6.14: all components in the upper levels are covers of either trivial cylinders or gradient flow cylinders, each with covering multiplicity at most 2. Aside from the ordering of the punctures, the only ambiguity involved in the upper levels is therefore the option to replace each gradient flow cylinder with its partner in a canceling pair. But by the argument in Lemma 6.21, this alteration does not change the value of  $u * u$  or  $u * v$  for any other building

$v$  with  $([v], \tau) \in \widehat{\mathcal{M}}^{\mathcal{F}}(\{\widehat{J}_\tau\})$ . In particular, since  $u$  is equivalent to some building arising as a limit of a sequence of nicely embedded index 2 curves,  $u * u = 0$ , implying that any other smooth curve obtained by gluing  $u$  will also be nicely embedded and therefore an element of  $\widehat{\mathcal{M}}_{\text{nice}}^{\mathcal{F}}(\{\widehat{J}_\tau\})$ . This proves that the set is open as claimed, hence it is a union of connected components of  $\widehat{\mathcal{M}}^{\mathcal{F}}(\{\widehat{J}_\tau\}) \setminus (\widehat{\mathcal{M}}^{\mathcal{F}+}(J_+) \times [0, 1])$ . Since  $\widehat{\mathcal{M}}_{\text{nice}}^{\mathcal{F}}(\{\widehat{J}_\tau\})$  also contains the holomorphic pages in  $\widehat{N}_+(\partial E)$  that form a neighborhood of  $\widehat{\mathcal{M}}^{\mathcal{F}+}(J_+) \times [0, 1]$  in  $\widehat{\mathcal{M}}^{\mathcal{F}}(\{\widehat{J}_\tau\})$ , it now follows from the definition of  $\widehat{\mathcal{M}}^{\mathcal{F}}(\{\widehat{J}_\tau\})$  that  $\widehat{\mathcal{M}}_{\text{nice}}^{\mathcal{F}}(\{\widehat{J}_\tau\}) = \widehat{\mathcal{M}}^{\mathcal{F}}(\{\widehat{J}_\tau\}) \setminus (\widehat{\mathcal{M}}^{\mathcal{F}+}(J_+) \times [0, 1])$ . The claim about intersection numbers then follows from Proposition 4.15 via the homotopy invariance of the pairing  $u * u'$ .  $\square$

**Lemma 6.28.** *For each  $\tau \in [0, 1]$ , every point in  $\widehat{W}$  is in the image of the main level of a unique element of  $\widehat{\mathcal{M}}_{\text{nice}}^{\mathcal{F}}(\widehat{J}_\tau)$ .*

*Proof.* Let  $\Delta \subset \widehat{W} \times [0, 1]$  denote the set of all points  $(x, \tau)$  such that  $x$  is in the image of the main level for some equivalence class of buildings in  $\widehat{\mathcal{M}}_{-1}^{\mathcal{F}}(\widehat{J}_\tau) \cup \widehat{\mathcal{M}}_0^{\mathcal{F}}(\widehat{J}_\tau)$ . By Lemma 6.26,  $\Delta$  is the smooth image of a manifold with components of dimension at most 3, i.e. it is a “subset of codimension at least 2” in  $\widehat{W} \times [0, 1]$ . It follows that  $(\widehat{W} \times [0, 1]) \setminus \Delta$  is connected.

Now define  $\Theta \subset (\widehat{W} \times [0, 1]) \setminus \Delta$  as the set of all  $(x, \tau) \notin \Delta$  such that  $x$  is in the image of the main level for some equivalence class of buildings in  $\widehat{\mathcal{M}}_1^{\mathcal{F}}(\widehat{J}_\tau) \cup \widehat{\mathcal{M}}_2^{\mathcal{F}}(\widehat{J}_\tau)$ . Lemmas 6.24 and 6.25 imply that  $\Theta$  is an open subset of  $(\widehat{W} \times [0, 1]) \setminus \Delta$ , and Lemma 6.26 implies that it is also closed. We conclude that  $\widehat{W} = \Theta \cup \Delta$ , meaning every  $(x, \tau) \in \widehat{W} \times [0, 1]$  has the property that  $x$  is in the image of the main level for some element of  $\widehat{\mathcal{M}}_{\text{nice}}^{\mathcal{F}}(\widehat{J}_\tau)$ . Uniqueness then follows from the fact that any two such elements  $u$  and  $u'$  satisfy  $u * u' = 0$ , as Lemma 6.21 implies that any isolated intersection of the main levels would make  $u * u'$  positive.  $\square$

We’ve now shown that for every  $\tau \in [0, 1]$ , the main levels of the buildings representing elements of  $\widehat{\mathcal{M}}_{\text{nice}}^{\mathcal{F}}(\widehat{J}_\tau)$  define a smoothly  $\tau$ -dependent foliation  $\mathcal{F}_\tau$  of  $\widehat{W}$ , which is singular on the set

$$\widehat{W}_\tau^{\text{crit}} \subset \widehat{W}$$

consisting of images of nodes for main levels of elements in  $\widehat{\mathcal{M}}_{\text{sing}}^{\mathcal{F}}(\widehat{J}_\tau)$ . We thus obtain a continuous map

$$\Pi_\tau : \widehat{W} \rightarrow \widehat{\mathcal{M}}_{\text{nice}}^{\mathcal{F}}(\widehat{J}_\tau)$$

sending each point  $x \in \widehat{W}$  to the unique  $[u] \in \widehat{\mathcal{M}}_{\text{nice}}^{\mathcal{F}}(\widehat{J}_\tau)$  whose main level contains  $x$ , and the resulting map

$$\Pi : \widehat{W} \times [0, 1] \rightarrow \widehat{\mathcal{M}}_{\text{nice}}^{\mathcal{F}}(\{\widehat{J}_\tau\}) : (x, \tau) \mapsto (\Pi_\tau(x), \tau)$$

is also continuous. The remaining steps toward the proof of Propositions 6.3 and 6.4 are to define a suitable smooth structure on  $\widehat{\mathcal{M}}_{\text{nice}}^{\mathcal{F}}(\{\widehat{J}_\tau\})$  and to understand the topological relationship between the sets  $\widehat{\mathcal{M}}^{\mathcal{F}}(\widehat{J})$  and  $\widehat{\mathcal{M}}^{\mathcal{F}}(\{\widehat{J}_\tau\})$  and their various subsets of regular, singular and exotic curves. To obtain a smooth structure and orientation on  $\widehat{\mathcal{M}}_{\text{nice}}^{\mathcal{F}}(\{\widehat{J}_\tau\})$ , we can conveniently make use of the foliations  $\mathcal{F}_\tau$  and thus avoid talking about smoothness of gluing maps or coherent orientations.

**Lemma 6.29.** *The spaces  $\widehat{\mathcal{M}}_{\text{nice}}^{\mathcal{F}}(\{\widehat{J}_\tau\})$  and  $\widehat{\mathcal{M}}_{\text{nice}}^{\mathcal{F}}(\widehat{J}_\tau)$  for each  $\tau \in [0, 1]$  admit unique smooth structures such that the maps  $\Pi_\tau$  and  $\Pi$  are smooth, except possibly at  $\widehat{W}_\tau^{\text{crit}}$  and*

$\bigcup_{\tau \in [0,1]} W_\tau^{\text{crit}} \times \{\tau\}$  respectively. Moreover,  $\widehat{\mathcal{M}}_{\text{nice}}^{\mathcal{F}}(\{\widehat{\mathcal{J}}_\tau\})$  is orientable, and there exists a diffeomorphism

$$\Psi : \widehat{\mathcal{M}}_{\text{nice}}^{\mathcal{F}}(\widehat{\mathcal{J}}) \times [0, 1] \rightarrow \widehat{\mathcal{M}}_{\text{nice}}^{\mathcal{F}}(\{\widehat{\mathcal{J}}_\tau\})$$

which satisfies  $\Psi(\widehat{\mathcal{M}}_{\text{nice}}^{\mathcal{F}}(\widehat{\mathcal{J}}) \times \{\tau\}) = \widehat{\mathcal{M}}_{\text{nice}}^{\mathcal{F}}(\widehat{\mathcal{J}}_\tau)$  for every  $\tau \in [0, 1]$  and is the identity map on  $\widehat{\mathcal{M}}_{\text{nice}}^{\mathcal{F}}(\widehat{\mathcal{J}}) \times \{0\}$  and the neighborhood of  $\widehat{\mathcal{M}}^{\mathcal{F}+}(J_+) \times [0, 1]$  defined by the holomorphic pages in  $\widehat{\mathcal{N}}_+(\partial E)$ .

*Proof.* Given  $([u], \tau) \in \widehat{\mathcal{M}}_{\text{nice}}^{\mathcal{F}}(\{\widehat{\mathcal{J}}_\tau\})$ , pick a point  $p \in \widehat{W}$  that is in the image of a non-nodal point of the main level of  $[u]$ . Choose also a small embedded open 2-disk  $\mathcal{D}_p \subset \widehat{W}$  that has  $p$  in its interior and is positively transverse to the foliation  $\mathcal{F}_\tau$ . Then after shrinking  $\mathcal{D}_p$  if necessary, we can assume that the main level curve for every element in some neighborhood  $\mathcal{U} \subset \widehat{\mathcal{M}}_{\text{nice}}^{\mathcal{F}}(\widehat{\mathcal{J}}_\tau)$  of  $[u]$  passes through a unique point of  $\mathcal{D}_p$ , thus defining a homeomorphism  $\mathcal{U} \rightarrow \mathcal{D}_p$ . (A crucial detail behind this assertion is that all of the main levels of elements in  $\widehat{\mathcal{M}}_{\text{nice}}^{\mathcal{F}}(\{\widehat{\mathcal{J}}_\tau\})$  are embedded—in particular none of them are multiply covered, otherwise the map  $\mathcal{U} \rightarrow \mathcal{D}_p$  would be multi-valued.) We shall identify  $\mathcal{D}_p$  smoothly with the open unit disk in  $\mathbb{C}$  and regard  $\mathcal{U} \rightarrow \mathcal{D}_p$  as a chart. Since the foliation is smooth and has a canonical co-orientation determined by the almost complex structure, all transition maps relating two charts of this type are smooth and orientation preserving. In the same manner, the smooth dependence of  $\mathcal{F}_\tau$  on  $\tau$  allows us to define local charts on  $\widehat{\mathcal{M}}_{\text{nice}}^{\mathcal{F}}(\{\widehat{\mathcal{J}}_\tau\})$  since  $\mathcal{D}_p$  can still be assumed positively transverse to  $\mathcal{F}_{\tau'}$  for all  $\tau'$  sufficiently close to  $\tau$ . This makes  $\widehat{\mathcal{M}}_{\text{nice}}^{\mathcal{F}}(\{\widehat{\mathcal{J}}_\tau\})$  a smooth oriented manifold in which the function

$$\widehat{\mathcal{M}}_{\text{nice}}^{\mathcal{F}}(\{\widehat{\mathcal{J}}_\tau\}) \rightarrow [0, 1] : ([u], \tau) \mapsto \tau$$

is a smooth function with no critical points. The existence of the diffeomorphism  $\Psi$  follows since the foliations  $\mathcal{F}_\tau$  match  $\mathcal{F}_+$  and are thus  $\tau$ -independent in the region of  $\widehat{\mathcal{N}}_+(\partial E)$  foliated by holomorphic pages.  $\square$

**Lemma 6.30.** *Using the diffeomorphism  $\Psi$  from Lemma 6.29, the sets  $\widehat{\mathcal{M}}_{\text{sing}}^{\mathcal{F}}(\{\widehat{\mathcal{J}}_\tau\})$  and  $\widehat{\mathcal{M}}_{\text{exot}}^{\mathcal{F}}(\{\widehat{\mathcal{J}}_\tau\})$  are each disjoint unions of finite collections of subsets of the form*

$$\left\{ \Psi(f(\tau), \tau) \in \widehat{\mathcal{M}}_{\text{nice}}^{\mathcal{F}}(\{\widehat{\mathcal{J}}_\tau\}) \mid \tau \in [0, 1] \right\},$$

for continuous maps  $f : [0, 1] \rightarrow \widehat{\mathcal{M}}_{\text{nice}}^{\mathcal{F}}(\widehat{\mathcal{J}})$  that are smooth except at finitely many points in  $(0, 1)$ .

*Proof.* Recall from Proposition 6.14 the finite subset

$$I^{\text{sing}} \subset (0, 1),$$

which in the present context we can regard as the set of all parameter values  $\tau$  such that the foliation  $\mathcal{F}_\tau$  contains a leaf of index  $-1$  (and only one such leaf). When  $\tau \notin I^{\text{sing}}$ , Lemma 6.26 identifies  $\widehat{\mathcal{M}}_{\text{sing}}^{\mathcal{F}}(\widehat{\mathcal{J}}_\tau)$  and  $\widehat{\mathcal{M}}_{\text{exot}}^{\mathcal{F}}(\widehat{\mathcal{J}}_\tau)$  with  $\widehat{\mathcal{M}}_{\text{sing},0}^{\mathcal{F}}(\widehat{\mathcal{J}}_\tau)$  and  $\widehat{\mathcal{M}}_{\text{exot},0}^{\mathcal{F}}(\widehat{\mathcal{J}}_\tau)$  respectively, which are each compact and are made up of equivalence classes whose main levels contain nicely embedded index 0 curves with simple elliptic asymptotic orbits. These curves satisfy the automatic transversality criterion of Proposition 2.12, hence there are finitely many of them for each  $\tau$  and they can be deformed smoothly under small perturbations in  $\tau$ . In particular, transversality implies that the projection

$$(6.12) \quad \widehat{\mathcal{M}}_{\text{sing},0}^{\mathcal{F}}(\{\widehat{\mathcal{J}}_\tau\}) \cup \widehat{\mathcal{M}}_{\text{exot},0}^{\mathcal{F}}(\{\widehat{\mathcal{J}}_\tau\}) \rightarrow [0, 1] : ([u], \tau) \mapsto \tau$$

is a submersion.

We claim next that if  $\tau_0 \in I^{\text{sing}}$  and

$$\left\{ ([u_\tau], \tau) \in \widehat{\mathcal{M}}_{\text{sing}}^{\mathcal{F}}(\{\widehat{J}_\tau\}) \mid \tau \in (\tau_0 - \epsilon, \tau_0) \right\}$$

is a smooth 1-parameter family, then this family admits a unique continuous extension to  $\tau \in (\tau_0 - \epsilon, \tau_0 + \epsilon)$  if  $\epsilon > 0$  is sufficiently small, and the extended family is also smooth for  $\tau \in (\tau_0, \tau_0 + \epsilon)$ . The compactness results of §6.3 imply that as  $\tau \rightarrow \tau_0$  from below,  $[u_\tau]$  converges to an element  $[u_{\tau_0}]$  of either  $\widehat{\mathcal{M}}_{\text{sing},0}^{\mathcal{F}}(\widehat{J}_{\tau_0})$  or  $\widehat{\mathcal{M}}_{\text{sing},-1}^{\mathcal{F}}(\widehat{J}_{\tau_0})$ . In the first case we can again use automatic transversality and apply the implicit function theorem to continue the family. In the second case, we can assume that the smooth curves  $u_\tau$  representing  $[u_\tau]$  converge to a holomorphic building  $u_{\tau_0}$  as in case (2h) of Prop. 6.14, whose main level is a nodal curve with one index 0 and one index  $-1$  component, and the upper levels consist of a gradient flow cylinder connecting the unique hyperbolic orbit of the index  $-1$  curve to an elliptic orbit. All components in this building are parametrically Fredholm regular, i.e. they are points at which the relevant parametric moduli space  $\{(v, \tau) \mid \tau \in [0, 1], v \text{ is } J_\tau\text{-holomorphic}\}$  is cut out transversely by the nonlinear Cauchy-Riemann operator. It follows that  $u_{\tau_0}$  can be glued in a unique way, proving that all pairs  $(u, \tau)$  close to  $(u_{\tau_0}, \tau_0)$  in the SFT-topology belong to the given family  $\{(u_\tau, \tau) \mid \tau \in (\tau_0 - \epsilon, \tau_0)\}$ . However, one can also replace the gradient flow cylinder in the upper level of  $u_{\tau_0}$  with its canceling partner from Lemma 6.1, giving a new building  $u'_{\tau_0}$ , which can be glued to obtain a new smooth 1-parameter family of elements in  $\widehat{\mathcal{M}}_{\text{sing},0}^{\mathcal{F}}(\{\widehat{J}_\tau\})$  with an end degenerating to  $u'_{\tau_0}$ . Since the index 0 curves forming the new family have the same asymptotic orbits as the components of  $u_\tau$  and each have normal Chern number  $-1$ , Proposition 2.13 implies that these two components of  $\widehat{\mathcal{M}}_{\text{sing},0}^{\mathcal{F}}(\{\widehat{J}_\tau\})$  receive the same orientation, for which the submersion (6.12) either preserves or reverses orientation. But these coherent orientations also assign opposite signs to the two canceling gradient flow cylinders, and hence to the buildings  $u_{\tau_0}$  and  $u'_{\tau_0}$  that form the boundaries of our two families in  $\widehat{\mathcal{M}}_{\text{sing},0}^{\mathcal{F}}(\{\widehat{J}_\tau\})$ . It follows that the family we obtained by gluing consists of pairs  $([u], \tau)$  with  $\tau > \tau_0$ , not  $\tau \leq \tau_0$ , thus continuing the family as claimed. The uniqueness of the continuation follows from the observation that the two buildings  $u_{\tau_0}$  and  $u'_{\tau_0}$  are the *only* possible representatives of  $[u_{\tau_0}] \in \widehat{\mathcal{M}}_{\text{sing}}^{\mathcal{F}}(\widehat{J}_{\tau_0})$  up to ordering of the punctures.

The proof of the same claim for  $\widehat{\mathcal{M}}_{\text{exot}}^{\mathcal{F}}(\{\widehat{J}_\tau\})$  is entirely analogous, the main difference being that there are now two possible types of degenerations from 1-parameter families in  $\widehat{\mathcal{M}}_{\text{exot},0}^{\mathcal{F}}(\{\widehat{J}_\tau\})$  to buildings in  $\widehat{\mathcal{M}}_{\text{exot},-1}^{\mathcal{F}}(\{\widehat{J}_\tau\})$ , as the unique hyperbolic orbit for the index  $-1$  curve may or may not be the same one that is doubly covered, i.e. this is the distinction between cases (2g) and (2j) in Prop. 6.14. If it is not the same orbit, then the upper levels contain a gradient flow cylinder, and the family is continued exactly as above by gluing its canceling partner. If the hyperbolic orbit is doubly covered, then we instead have an unbranched double cover of a gradient flow cylinder in an upper level, but as observed in Lemma 6.1, this unbranched cover also satisfies automatic transversality and is oriented opposite to the unbranched double cover of its canceling partner. Thus the same trick works to continue the family, this time by replacing the unbranched cover with its own canceling partner and then gluing the building. Note that for this picture of  $\widehat{\mathcal{M}}_{\text{exot}}^{\mathcal{F}}(\{\widehat{J}_\tau\})$  to be complete, one must also picture an index 2 branched double cover of a trivial cylinder over an elliptic orbit in the top level of every building, as appears in case (2e) of Proposition 6.13 and cases (2g) and (2j) of

Proposition 6.14. But this branched cover can be treated as a constant object that plays no role in the deformation or gluing arguments.

As a final remark, note that there are other types of buildings listed in Proposition 6.14 that can represent elements of  $\widehat{\mathcal{M}}_{\text{exot},-1}^{\mathcal{F}}(\widehat{J}_{\tau_0})$  and may arise as degenerations of index 2 curves, namely cases (2i) and (2k). However, since they do not include any branched cover of a trivial cylinder in the top level, these cannot arise as degenerations of curves in  $\widehat{\mathcal{M}}_{\text{exot},0}^{\mathcal{F}}(\{\widehat{J}_{\tau}\})$ , which are always represented by case (2e) of Proposition 6.13. Moreover, they are equivalent in  $\widehat{\mathcal{M}}_{\text{exot},-1}^{\mathcal{F}}(\{\widehat{J}_{\tau}\})$  to buildings from case (2j), and can thus be replaced by such buildings in order to obtain two glued families<sup>12</sup> in the way described above, so that they always uniquely fit into the same 1-parameter families in  $\widehat{\mathcal{M}}_{\text{exot}}^{\mathcal{F}}(\{\widehat{J}_{\tau}\})$  moving  $\tau$  both forward and backward.  $\square$

The lemmas proved so far establish the main topological properties of the spaces  $\widehat{\mathcal{M}}^{\mathcal{F}}(\widehat{J}_{\tau})$  and  $\widehat{\mathcal{M}}^{\mathcal{F}}(\{\widehat{J}_{\tau}\})$  as described in Propositions 6.3 and 6.4. It remains only to examine the restrictions of the maps  $\Pi_{\tau} : \widehat{W} \rightarrow \widehat{\mathcal{M}}_{\text{nice}}^{\mathcal{F}}(\widehat{J}_{\tau})$  to the holomorphic vertebrae  $\dot{\Sigma}_i \subset \widehat{W}$  for  $i = 1, \dots, r$ . The resulting maps

$$\dot{\Sigma}_i \xrightarrow{\Pi_{\tau}} \widehat{\mathcal{M}}_{\text{nice}}^{\mathcal{F}}(\widehat{J}_{\tau})$$

are local diffeomorphisms wherever the foliation  $\mathcal{F}_{\tau}$  is transverse to  $\dot{\Sigma} := \dot{\Sigma}_1 \cup \dots \cup \dot{\Sigma}_r$ . By Lemma 6.7, non-transverse intersections of main level curves with  $\dot{\Sigma}$  occur only for elements in a 1-dimensional submanifold of  $\widehat{\mathcal{M}}_2^{\mathcal{F}}(\{\widehat{J}_{\tau}\})$  and a discrete subset of  $\widehat{\mathcal{M}}_1^{\mathcal{F}}(\{\widehat{J}_{\tau}\})$ , and moreover, each individual curve in these spaces has only one non-transverse intersection, with local intersection index 2. With this understood, the following local result serves to characterize the maps  $\dot{\Sigma} \xrightarrow{\Pi_{\tau}} \widehat{\mathcal{M}}_{\text{nice}}^{\mathcal{F}}(\widehat{J}_{\tau})$  as generic branched covers.

**Lemma 6.31.** *Suppose  $J$  is a smooth almost complex structure on  $\mathbb{C}^2$ ,*

$$u_{\zeta} : (\mathbb{D}, i) \rightarrow (\mathbb{C}^2, J) \quad \text{for} \quad \zeta \in \mathbb{D}$$

*is a smooth 2-parameter family of  $J$ -holomorphic curves such that  $u_0(0) = 0$  and the map  $\mathbb{D} \times \mathbb{D} \rightarrow \mathbb{C}^2 : (z, \zeta) \mapsto u_{\zeta}(z)$  is an embedding, and  $\Sigma \subset \mathbb{C}^2$  is an embedded  $J$ -holomorphic curve that has an isolated intersection of index  $k \in \mathbb{N}$  with  $u_0$  at the origin. Then the map*

$$\Sigma \rightarrow \mathbb{D} : w \mapsto \zeta(w) \quad \text{such that} \quad w \in \text{im } u_{\zeta(w)}$$

*has the local structure of a branched cover, with the origin as a branch point of order  $k$ .*

*Proof.* The statement follows immediately from transversality if  $k = 1$ , so let us assume  $k \geq 2$ . After a change of coordinates, we can assume without loss of generality that

$$u_{\zeta}(z) = (z, \zeta) \quad \text{and} \quad J(z, \zeta) = \begin{pmatrix} i & \alpha(z, \zeta) \\ 0 & j(z, \zeta) \end{pmatrix}$$

for  $\text{End}_{\mathbb{R}}(\mathbb{C})$ -valued functions  $\alpha, j$  that satisfy  $j^2 = -\mathbf{1}$  and  $i\alpha + \alpha j = 0$ . In these coordinates, we can write  $\Sigma$  near the origin as the image of an embedded  $J$ -holomorphic disk  $v = (\varphi, f) : (\mathbb{D}, i) \rightarrow (\mathbb{C}^2, J)$  that satisfies  $\varphi(0) = f(0) = 0$  by assumption, and the condition  $k \geq 2$  implies a tangential intersection with  $u_0$ , thus  $df(0) = 0$ , so that  $\varphi : \mathbb{D} \rightarrow \mathbb{C}$  can be assumed an embedding. Since the family of curves  $u_{\zeta}$  is parametrized by the second complex coordinate, our goal is now to show that the function  $f : \mathbb{D} \rightarrow \mathbb{C}$  has the structure of a  $k$ -to-1 branch

<sup>12</sup>It is worth clarifying that no obstruction bundle gluing (in the sense of [HT09]) is required here, as the branched covers in our picture serve merely as a bit of extra data that is not involved in the gluing construction.



point at 0. This follows easily from the similarity principle: writing  $v_0(z) := (\varphi(z), 0)$ , the equation  $\partial_s v + J(v)\partial_t v = 0$  implies

$$\begin{aligned} \partial_s v + J(v_0)\partial_t v &= \begin{pmatrix} \partial_s \varphi \\ \partial_s f \end{pmatrix} + \begin{pmatrix} i & \alpha(\varphi, 0) \\ 0 & j(\varphi, 0) \end{pmatrix} \begin{pmatrix} \partial_t \varphi \\ \partial_t f \end{pmatrix} = -[J(v) - J(v_0)]\partial_t v \\ &= -\left(\int_0^1 D_2 J(\varphi, tf) \cdot f \, dt\right) \partial_t v =: -\tilde{A}f, \end{aligned}$$

where the linear dependence of the integral in the second line on  $f$  is used to define a smooth function  $\tilde{A} : \mathbb{D} \rightarrow \text{Hom}_{\mathbb{R}}(\mathbb{C}, \mathbb{C}^2)$ . Projecting all of this to the second factor in  $\mathbb{C} \times \mathbb{C}$  then produces a linear Cauchy-Riemann type equation  $\partial_s f + j(\varphi, 0)\partial_t f + Af = 0$ , and since the intersection of  $v$  with  $u_0$  is isolated, the similarity principle now implies that  $f$  has a nontrivial Taylor series whose first nonzero term is holomorphic. That term must be a multiple of  $z^k$ , in light of the intersection index, thus  $f$  is given by

$$f(z) = az^k + |z|^k R(z)$$

for some nonzero coefficient  $a \in \mathbb{C}$  and a continuous remainder function satisfying  $R(0) = 0$ . On a small enough neighborhood of 0 so that  $|R(z)| < |a|$ , this can also be written as  $f(w) = w^k$  in a new  $C^1$ -smooth complex coordinate defined by  $w := z \left(a + \frac{|z|^k}{z^k} R(z)\right)^{1/k}$ .  $\square$

For the next statement, let  $\bar{\Sigma}_i$  denote the compact topological surface obtained by adding circles at infinity to each of the cylindrical ends of  $\dot{\Sigma}_i$ .

**Lemma 6.32.** *For each  $i = 1, \dots, r$  and every  $\tau \in [0, 1]$ , the map  $\dot{\Sigma}_i \xrightarrow{\Pi_\tau} \widehat{\mathcal{M}}_{\text{nice}}^{\mathcal{F}}(\hat{J}_\tau)$  extends to a continuous map*

$$(\bar{\Sigma}_i, \partial\bar{\Sigma}_i) \rightarrow \left(\widehat{\mathcal{M}}^{\mathcal{F}}(\hat{J}_\tau), \widehat{\mathcal{M}}^{\mathcal{F}+}(J_+)\right)$$

*of degree  $m_i$  whose restriction to the boundary is a covering map. Moreover, it is a generic branched cover of surfaces with cylindrical ends in the sense of Definition 6.2, the images in  $\widehat{\mathcal{M}}_{\text{nice}}^{\mathcal{F}}(\hat{J}_\tau)$  of the branch points all lie in  $\widehat{\mathcal{M}}_{\text{reg}}^{\mathcal{F}}(\hat{J}_\tau)$ , and the nodes of curves in  $\widehat{\mathcal{M}}_{\text{sing}}^{\mathcal{F}}(\hat{J}_\tau)$  never intersect  $\dot{\Sigma}_i$ .*

*Proof.* The continuous extension and its degree are already clear from the fact that the holomorphic pages (which form the cylindrical ends of  $\widehat{\mathcal{M}}_{\text{nice}}^{\mathcal{F}}(\hat{J}_\tau)$ ) each have exactly  $m_i$  intersections with  $\dot{\Sigma}_i$ , all of them transverse. That  $\Pi_\tau|_{\dot{\Sigma}_i}$  is a branched cover with only simple branch points follows from Lemma 6.31, together with the preceding remarks on genericity and intersections. The branch points are the tangential intersections of  $\dot{\Sigma}_i$  with leaves of the foliation, and Lemma 6.7 implies that such a point  $\zeta$  is necessarily the only point of tangency on a given leaf, hence all images of branch points are distinct. Finally, Lemma 6.7 implies that the index 0 and  $-1$  main level components in  $\widehat{\mathcal{M}}_{\text{sing}}^{\mathcal{F}}(\hat{J}_\tau)$  and  $\widehat{\mathcal{M}}_{\text{exot}}^{\mathcal{F}}(\hat{J}_\tau)$  always intersect  $\dot{\Sigma}_i$  transversely, hence these are never critical values of the branched cover. Lemma 6.8 implies in turn that the two components of each nodal curve in  $\widehat{\mathcal{M}}_{\text{sing}}^{\mathcal{F}}(\hat{J}_\tau)$  never intersect  $\dot{\Sigma}_i$  in the same places, hence their intersections with  $\dot{\Sigma}_i$  are disjoint from the node.  $\square$

Our final lemma in this section concerns the Lefschetz-amenable case.

**Lemma 6.33.** *The branched cover in Lemma 6.32 has no branch points if and only if  $\widehat{\mathcal{M}}_{\text{exot}}^{\mathcal{F}}(\hat{J}_\tau) = \emptyset$  for all  $\tau \in [0, 1]$ .*

*Proof.* We show first that the absence of branch points rules out exotic fibers. By Lemma 6.30, it suffices to prove that  $\widehat{\mathcal{M}}_{\text{exot}}^{\mathcal{F}}(\widehat{J})$  is empty whenever  $\dot{\Sigma} \xrightarrow{\Pi_0} \widehat{\mathcal{M}}_{\text{nice}}^{\mathcal{F}}(\widehat{J})$  is an honest covering map. Recall from Proposition 3.8 that the holomorphic vertebrae  $\dot{\Sigma}_i$  are not isolated: each can be shifted in the direction of the  $\theta$ -coordinate, producing a smooth  $S^1$ -family of embedded  $J$ -holomorphic curves  $\dot{\Sigma}_i^\theta \subset \widehat{W}$  that foliate a smooth hypersurface

$$Y_i := \bigcup_{\theta \in S^1} \dot{\Sigma}_i^\theta \subset \widehat{W}.$$

We cannot assume that the genericity conditions imposed in §6.2 hold for intersections of leaves with *every* curve in the family  $\dot{\Sigma}_i^\theta$ , thus a leaf may have intersections of index greater than 2 with some of these curves, but the intersections are still isolated and positive, thus Lemma 6.31 still applies and gives each of the maps  $\dot{\Sigma}_i^\theta \xrightarrow{\Pi_0} \widehat{\mathcal{M}}_{\text{nice}}^{\mathcal{F}}(\widehat{J})$  the structure of a (not necessarily generic) branched cover. The rest of the arguments in Lemma 6.32 also apply for every  $\theta$ , showing that the branch points of these covers are confined to a compact subset, and they can be counted algebraically using the Riemann-Hurwitz formula. It follows that the condition of having no branch points is independent of  $\theta$ , hence this assumption implies that every leaf of the foliation is transverse to the entire hypersurface  $Y := Y_1 \cup \dots \cup Y_r$ .

Recall that a neighborhood of infinity in  $\widehat{\mathcal{M}}_{\text{nice}}^{\mathcal{F}}(\widehat{J})$  coincides with the foliation  $\mathcal{F}_+$  constructed in §3.8, and each leaf of the latter intersects the region of  $\widehat{E}$  above  $Y$  in a disjoint union of cylindrical ends whose boundary circles are in bijective correspondence with the boundary components of the pages (see Figure 7), each of them having degree 1 under the projection  $\widehat{\Sigma} \times S^1 \rightarrow S^1$ . In light of the transverse intersections with  $Y$ , it follows that the same is true for *every* leaf of  $\mathcal{F}_0$ , implying that none can have an end asymptotic to a doubly covered orbit (see Figure 9E), which must occur if  $\widehat{\mathcal{M}}_{\text{exot}}^{\mathcal{F}}(\widehat{J})$  were nonempty.

Conversely, if  $\widehat{\mathcal{M}}_{\text{exot}}^{\mathcal{F}}(\widehat{J}) = \emptyset$ , then all main level curves in  $\widehat{\mathcal{M}}_{\text{nice}}^{\mathcal{F}}(\widehat{J})$  have the same number of ends with the same asymptotic orbits and multiplicities. We claim that for any  $\theta \in S^1$  and  $t > 0$  sufficiently large, all of them are transverse to the properly embedded surface  $\dot{\Sigma}^{(t,\theta)} := \{t\} \times \widehat{\Sigma} \times \{\theta\} \subset \widehat{N}(\partial_h E)$ . Indeed, this is obvious for the holomorphic pages constructed in §3.8, which form a neighborhood of infinity in the moduli space, and for everything else the claim follows for  $t \gg 0$  due to the asymptotic convergence of curves to Reeb orbits, which are never tangent to  $\dot{\Sigma}^{(t,\theta)}$ . The restriction of  $\Pi$  to  $\dot{\Sigma}^{(t,\theta)}$  is therefore a proper covering map and thus satisfies the Riemann-Hurwitz formula, with 0 for the count of branch points. Since  $\dot{\Sigma}^{(t,\theta)}$  and  $\dot{\Sigma} = \dot{\Sigma}_1 \cup \dots \cup \dot{\Sigma}_r$  are homeomorphic, it now also follows from the Riemann-Hurwitz formula that  $\Pi|_{\dot{\Sigma}}$  cannot have branch points.  $\square$

The proof of Propositions 6.3 and 6.4 is now complete.

**6.5. The Lefschetz fibration on the filling.** We can now finish the proof of Theorems 1.5 and 1.10 by showing that if the spinal open book  $\pi$  is Lefschetz-amenable, then the stable foliation from Propositions 6.3 and 6.4 gives rise to a bordered Lefschetz fibration supporting the symplectic structure of  $W$ .

Assume  $\pi$  is Lefschetz-amenable, so according to Proposition 6.3, the set  $\widehat{\mathcal{M}}_{\text{exot}}^{\mathcal{F}}(\widehat{J})$  is empty and  $\widehat{W}$  is foliated (with finitely many singular points) by a mixture of smoothly embedded  $\widehat{J}$ -holomorphic curves and finitely many nodal curves that look like Lefschetz singular fibers. Recall from §3.9 the bounded subdomains  $\widehat{E}_R \subset \widehat{E}$  for  $R > 0$ , and let

$$\widehat{W}_R \subset \widehat{W}$$

denote the compact subdomain in  $\widehat{W}$  with  $\partial\widehat{W}_R = \partial\widehat{E}_R$ ; its boundary (see Figure 8) is piecewise smooth and splits naturally into horizontal and vertical faces

$$\partial\widehat{W}_R = \partial_v\widehat{W}_R \cup \partial_h\widehat{W}_R.$$

These subdomains with their symplectic and/or almost Stein data are deformation equivalent to  $W$  by Lemma 3.14. Now by taking  $R > 0$  sufficiently large, we can assume near  $\partial\widehat{W}_R$  that the foliation formed by the  $\widehat{J}$ -holomorphic curves in  $\widehat{\mathcal{M}}^{\mathcal{F}}(\widehat{J})$  is arbitrarily  $C^\infty$ -close to the  $\mathbb{R}$ -invariant foliation  $\mathcal{F}_+$ ; this follows from the fact that sequences of curves in  $\widehat{\mathcal{M}}^{\mathcal{F}}(\widehat{J})$  escaping to infinity necessarily converge to curves in  $\widehat{\mathcal{M}}^{\mathcal{F}_+}(J_+)$ . In fact, these two foliations match precisely near  $\partial_v\widehat{W}_R$ , since the curves in this region are contained fully in the cylindrical end. Near  $\partial_h\widehat{W}_R$ , we can now make a  $C^\infty$ -small modification “by hand” of the almost complex structure and the holomorphic curves so that the latter become precisely tangent to  $\mathcal{F}_+$ . After this modification, consider the restriction

$$\Pi : \widehat{W}_R \rightarrow \Sigma_0$$

of the map in Proposition 6.3, where we define  $\Sigma_0 \subset \widehat{\mathcal{M}}^{\mathcal{F}}(\widehat{J})$  as the image of this restricted map. What we lose by forgetting  $\widehat{W} \setminus \widehat{W}_R$  is a collection of 1-parameter families of curves contained in  $\widehat{\mathcal{N}}_+(\partial E)$ ; these form collar neighborhoods of the boundary in  $\widehat{\mathcal{M}}^{\mathcal{F}}(\widehat{J})$ , hence  $\Sigma_0$  is a compact surface with the same topological type as  $\widehat{\mathcal{M}}^{\mathcal{F}}(\widehat{J})$ . Since the nodal singularities can all be assumed to lie in the interior of  $\widehat{W}_R$  for  $R$  sufficiently large,  $\Pi : \widehat{W}_R \rightarrow \Sigma_0$  is now a bordered Lefschetz fibration, and it is allowable if  $(\widehat{W}_R, \widehat{\omega})$  is minimal—which is true if and only if  $(W, \omega)$  is minimal—since the only closed components allowed by the compactness results in §6.3 are embedded spheres with self-intersection number  $-1$ . Lemma 3.15 implies moreover that  $\Pi : \widehat{W}_R \rightarrow \Sigma_0$  supports the symplectic and/or Liouville structure of  $\widehat{W}_R$ , and in the almost Stein case,  $(\widehat{W}_R, \widehat{J}, \widehat{f})$  is almost Stein deformation equivalent to the canonical structure for this Lefschetz fibration by [LVW, Theorem C]. With this, we’ve proved that the maps in Theorem 1.5 sending equivalence classes of Lefschetz fibrations to equivalence classes of fillings are surjective.

To show that these maps are also injective, suppose we have two bordered Lefschetz fibrations bounded by  $\pi$  that give rise to deformation equivalent fillings. These Lefschetz fibrations then admit “double completions” formed by gluing them into the model  $\widehat{E}$  from §3 so that their vertical subbundles match  $VE$  near their boundaries, and we can choose tame almost complex structures on both that match  $J_+$  on the end and make all fibers holomorphic. We can therefore view them both as holomorphic foliations on the same noncompact manifold  $\widehat{W}$ , corresponding to two distinct choices of almost complex structures  $\widehat{J}_0$  and  $\widehat{J}_1$  tamed by deformation-equivalent choices of symplectic data, all identical on  $\widehat{\mathcal{N}}_-(\partial E)$ . Choosing a deformation of the symplectic data and a corresponding deformation of tame almost complex structures, Proposition 6.4 then connects the two foliations by a smooth 1-parameter family, producing an isotopy of bordered Lefschetz fibrations which can be adjusted near  $\partial\widehat{W}_R$  as in the previous paragraph so that they support the family of symplectic structures. The proof of Theorems 1.5 and 1.10 is now complete.

**6.6. Quasiflexible Stein structures.** We now prove Theorem 1.13.

Assume  $\Pi : W \rightarrow \Sigma_0$  is an allowable bordered Lefschetz fibration with fibers of genus zero, and  $(J_0, f_0)$  is an almost Stein structure on  $W$  supported by  $\Pi$ . Assume further that  $(J_1, f_1)$  is

a second almost Stein structure on  $W$  such that the symplectic structures  $\omega_0 := -df_0 \circ J_0$  and  $\omega_1 := -df_1 \circ J_1$  are homotopic through a smooth family of symplectic structures  $\{\omega_\tau\}_{\tau \in [0,1]}$  that are convex at the boundary—recall that since  $\partial W$  has corners, the convexity condition means that the associated Liouville vector fields are outwardly transverse to both  $\partial_h W$  and  $\partial_v W$ . The aim is to show that the Weinstein structures induced by  $(J_0, f_0)$  and  $(J_1, f_1)$  are Weinstein homotopic.

The spinal open book  $\pi := \partial\Pi$  on  $M := \partial W$  has spine  $M_\Sigma = \partial_h W$  and paper  $M_P = \partial_v W$ , with the fibration  $\pi_\Sigma : M_\Sigma \rightarrow \Sigma$  obtained by factoring  $\partial_h E \xrightarrow{\Pi} \Sigma_0$  through a suitable covering map  $\Sigma \rightarrow \Sigma_0$  to make its fibers connected, and  $\pi_P : M_P \rightarrow S^1$  defined from  $\partial_v E \xrightarrow{\Pi} \partial\Sigma_0$  by identifying each component of  $\partial\Sigma_0$  with  $S^1$ . We assume in the following that this particular spinal open book is used for the construction of the model  $\widehat{E}$  in §3. Recall now from [LVW, Theorem 1.24] that the space of almost Stein structures supported by  $\Pi : W \rightarrow \Sigma_0$  is contractible, thus we are free after a deformation to assume that  $(J_0, f_0)$  matches an almost Stein structure constructed via the Thurston trick as in the proof of that theorem. Since the same application of the Thurston trick underlies the almost Stein model constructed in §3, one obtains the following result:

**Lemma 6.34.** *After a deformation of  $(J_0, f_0)$  through supported almost Stein structures on  $W$ , the model  $\widehat{E}$  in §3 can be constructed so that the bounded region  $E \subset \widehat{E}$  with its almost Stein data  $(J_+, f_+)$  admits a diffeomorphism with a neighborhood of  $\partial W$  in  $(W, J_0, f_0)$ , identifying  $\partial_h W = \partial_h E$ ,  $\partial_v W = \partial_v E$ , and the fibers of  $\Pi$  in this neighborhood with the fibers of  $\mathcal{N}(\partial_h E) \xrightarrow{\Pi_h} \Sigma$  and  $\mathcal{N}(\partial_v E) \xrightarrow{\Pi_v} (-1, 0] \times S^1$ .  $\square$*

Attaching  $(W, J_0, f_0)$  to  $(\widehat{E}, J_+, f_+)$  via the lemma produces a completed almost Stein domain  $(\widehat{W}, \widehat{J}_0, \widehat{f}_0)$  that is foliated by  $\widehat{J}_0$ -holomorphic curves matching the fibers of  $\Pi : W \rightarrow \Sigma_0$  in  $W$  and the leaves of the foliation  $\mathcal{F}_+$  on  $\widehat{W} \setminus W$ . Note that  $\widehat{J}_0$  in this construction cannot be assumed generic. Nonetheless, the almost Stein condition is open, so after a small perturbation of  $\Pi$  away from  $\partial W$  and a corresponding perturbation of  $(J_0, f_0)$  to ensure that the perturbed fibers are still  $J_0$ -holomorphic, we can assume without loss of generality that no curve in our  $\widehat{J}_0$ -holomorphic foliation of  $\widehat{W}$  has more than one end asymptotic to a hyperbolic orbit, and the finitely many curves that make up singular fibers have no ends asymptotic to hyperbolic orbits. Since these curves all have genus zero, it now follows that they all satisfy the criterion for automatic transversality from [Wen10b], so they will survive a further perturbation of  $\widehat{J}_0$  in the interior of  $W$ , which we now perform in order to assume the genericity conditions of §6.2. Denote the resulting  $\widehat{J}_0$ -holomorphic foliation of  $\widehat{W}$  by  $\mathcal{F}_0$ .

As in the proof of Theorem 1.5, our original almost Stein domain is Stein deformation equivalent to the enlarged compact domain  $(\widehat{W}_R, \widehat{J}_0, \widehat{f}_0)$  in  $\widehat{W}$  for  $R \gg 0$ . The symplectic deformation  $\{\omega_\tau\}_{\tau \in [0,1]}$  can now also be fit into this picture and gives rise to a smooth family of symplectic structures  $\widehat{\omega}_\tau$  on  $\widehat{W}$  that are independent of  $\tau$  on a neighborhood of infinity and match  $-d\widehat{f}_\tau \circ \widehat{J}_\tau$  for  $\tau \in \{0, 1\}$ , where  $(\widehat{J}_1, \widehat{f}_1)$  is a similar extension of the almost Stein structure  $(J_1, f_1)$  from  $W$  to  $\widehat{W}$ , matching  $(J_+, f_+)$  near infinity. By the contractibility of the space of tame almost complex structures, we can choose a generic family  $\{\widehat{J}_\tau\}_{\tau \in [0,1]}$  of  $\widehat{\omega}_\tau$ -tame almost complex structures that form a homotopy from  $\widehat{J}_0$  to  $\widehat{J}_1$  and match  $J_+$  near infinity. Using Proposition 6.4, the foliation  $\mathcal{F}_0$  now extends to a smooth family of  $\widehat{J}_\tau$ -holomorphic foliations  $\mathcal{F}_\tau$ , which includes smooth deformations of finitely many nodal curves (i.e. the

original singular fibers of  $\Pi$ ) from  $\tau = 0$  to  $\tau = 1$ , but does not include any exotic fibers since none were present in the foliation  $\mathcal{F}_0$ . Making the same modifications near infinity as in the proof of Theorem 1.5, the result is a smooth family of allowable bordered Lefschetz fibrations  $\Pi_\tau : \widehat{W}_R \rightarrow \Sigma_0$  supporting the symplectic structures  $\widehat{\omega}_\tau$  for  $R$  sufficiently large. Theorem C in [LVW] now implies that the Weinstein structure induced by  $(\widehat{J}_1, \widehat{f}_1)$  lies in the canonical Weinstein homotopy class supported by  $\Pi_1$ , implying that it is also Weinstein homotopic to the Weinstein structure induced by  $(\widehat{J}_0, \widehat{f}_0)$ . This completes the proof of the first statement in Theorem 1.13.

If  $\Sigma_0 = \mathbb{D}^2$ , then we can weaken the convexity hypothesis on the family of symplectic structures  $\{\omega_\tau\}_{\tau \in [0,1]}$  and assume instead that after smoothing the corners of  $\partial W$ , each  $(W, \omega_\tau)$  is a weak filling of  $(M := \partial W, \xi_\tau)$  for some smooth family of contact structures  $\xi_\tau$  on  $M$  matching  $\ker(-df_\tau \circ J_\tau|_{TM})$  for  $\tau \in \{0, 1\}$ . The key observation here is that every component of the spine  $M_\Sigma$  is a solid torus  $\mathbb{D}^2 \times S^1$ , on which all closed 2-forms are exact, so the possible non-exactness of  $\omega_\tau$  at  $\partial W$  can be absorbed into the above construction by including in the symplectic data near infinity a family of closed 2-forms  $\eta_\tau$  as in §3.3, which are assumed to vanish on  $\widehat{N}(\partial_h E)$  and vanish identically for  $\tau \in \{0, 1\}$ . Since  $\eta_\tau$  changes the Reeb vector field on the cylindrical end over the paper, it causes a change to  $\widehat{J}_\tau$  in this region, but the holomorphic pages here are tangent to the fixed integrable distribution  $\Xi_+$  and thus remain holomorphic. With this understood, the argument of the previous paragraph now goes through with no further changes, and the proof of Theorem 1.13 is thus complete.

## REFERENCES

- [BEV12] K. L. Baker, J. B. Etnyre, and J. Van Horn-Morris, *Cabling, contact structures and mapping class monoids*, J. Differential Geom. **90** (2012), no. 1, 1–80.
- [BV15] R. İ. Baykur and J. Van Horn-Morris, *Families of contact 3-manifolds with arbitrarily large Stein fillings*, J. Differential Geom. **101** (2015), no. 3, 423–465. With an appendix by S. Lisi and C. Wendl.
- [BEH<sup>+</sup>03] F. Bourgeois, Y. Eliashberg, H. Hofer, K. Wysocki, and E. Zehnder, *Compactness results in symplectic field theory*, Geom. Topol. **7** (2003), 799–888 (electronic).
- [BM04] F. Bourgeois and K. Mohnke, *Coherent orientations in symplectic field theory*, Math. Z. **248** (2004), no. 1, 123–146.
- [BN10] F. Bourgeois and K. Niederkrüger, *Towards a good definition of algebraically overtwisted*, Expo. Math. **28** (2010), no. 1, 85–100.
- [CE12] K. Cieliebak and Y. Eliashberg, *From Stein to Weinstein and back: symplectic geometry of affine complex manifolds*, Amer. Math. Soc., 2012. To appear.
- [CM07] K. Cieliebak and K. Mohnke, *Symplectic hypersurfaces and transversality in Gromov-Witten theory*, J. Symplectic Geom. **5** (2007), no. 3, 281–356.
- [CV] K. Cieliebak and E. Volkov, *First steps in stable Hamiltonian topology*. Preprint arXiv:1003.5084.
- [CGHa] V. Colin, P. Ghiggini, and K. Honda, *The equivalence of Heegaard Floer homology and embedded contact homology via open book decompositions I*. Preprint arXiv:1208.1074.
- [CGHb] ———, *The equivalence of Heegaard Floer homology and embedded contact homology via open book decompositions II*. Preprint arXiv:1208.1077.
- [CGHc] ———, *The equivalence of Heegaard Floer homology and embedded contact homology III: from hat to plus*. Preprint arXiv:1208.1526.
- [Dra04] D. L. Dragnev, *Fredholm theory and transversality for noncompact pseudoholomorphic maps in symplectizations*, Comm. Pure Appl. Math. **57** (2004), no. 6, 726–763.
- [Eli90] Y. Eliashberg, *Filling by holomorphic discs and its applications*, Geometry of low-dimensional manifolds, 2 (Durham, 1989), London Math. Soc. Lecture Note Ser., vol. 151, Cambridge Univ. Press, Cambridge, 1990, pp. 45–67.

- [Eli91] ———, *On symplectic manifolds with some contact properties*, J. Differential Geom. **33** (1991), no. 1, 233–238.
- [Eli96] Y. Eliashberg, *Unique holomorphically fillable contact structure on the 3-torus*, Internat. Math. Res. Notices **2** (1996), 77–82.
- [EGH00] Y. Eliashberg, A. Givental, and H. Hofer, *Introduction to symplectic field theory*, Geom. Funct. Anal., Special Volume (2000), 560–673.
- [ET98] Y. M. Eliashberg and W. P. Thurston, *Confoliations*, University Lecture Series, vol. 13, American Mathematical Society, Providence, RI, 1998.
- [Etn06] J. B. Etnyre, *Lectures on open book decompositions and contact structures*, Floer homology, gauge theory, and low-dimensional topology, Clay Math. Proc., vol. 5, Amer. Math. Soc., Providence, RI, 2006, pp. 103–141.
- [EH02] J. B. Etnyre and K. Honda, *On symplectic cobordisms*, Math. Ann. **323** (2002), no. 1, 31–39.
- [FS18] J. W. Fish and R. Siefring, *Connected sums and finite energy foliations I: Contact connected sums*, Journal of Symplectic Geometry **16** (2018), no. (6), 1639–1748.
- [FH93] A. Floer and H. Hofer, *Coherent orientations for periodic orbit problems in symplectic geometry*, Math. Z. **212** (1993), no. 1, 13–38.
- [Gay06] D. T. Gay, *Four-dimensional symplectic cobordisms containing three-handles*, Geom. Topol. **10** (2006), 1749–1759 (electronic).
- [Ghi05] P. Ghiggini, *Strongly fillable contact 3-manifolds without Stein fillings*, Geom. Topol. **9** (2005), 1677–1687 (electronic).
- [GH] P. Ghiggini and K. Honda, *Giroux torsion and twisted coefficients*. Preprint arXiv:0804.1568.
- [GHV] P. Ghiggini, K. Honda, and J. Van Horn-Morris, *The vanishing of the contact invariant in the presence of torsion*. Preprint arXiv:0706.1602.
- [Gir94] E. Giroux, *Une structure de contact, même tendue, est plus ou moins tordue*, Ann. Sci. École Norm. Sup. (4) **27** (1994), no. 6, 697–705 (French, with English summary).
- [Gir99] ———, *Une infinité de structures de contact tendues sur une infinité de variétés*, Invent. Math. **135** (1999), no. 3, 789–802 (French).
- [Gir00] ———, *Structures de contact en dimension trois et bifurcations des feuilletages de surfaces*, Invent. Math. **141** (2000), no. 3, 615–689 (French).
- [Gom04] R. E. Gompf, *Toward a topological characterization of symplectic manifolds*, J. Symplectic Geom. **2** (2004), no. 2, 177–206.
- [Gom05] ———, *Locally holomorphic maps yield symplectic structures*, Comm. Anal. Geom. **13** (2005), no. 3, 511–525.
- [GS99] R. E. Gompf and A. I. Stipsicz, *4-manifolds and Kirby calculus*, Graduate Studies in Mathematics, vol. 20, American Mathematical Society, Providence, RI, 1999.
- [Gro85] M. Gromov, *Pseudoholomorphic curves in symplectic manifolds*, Invent. Math. **82** (1985), no. 2, 307–347.
- [Hin00] R. Hind, *Holomorphic filling of  $\mathbf{RP}^3$* , Commun. Contemp. Math. **2** (2000), no. 3, 349–363.
- [Hin03] R. Hind, *Stein fillings of lens spaces*, Commun. Contemp. Math. **5** (2003), no. 6, 967–982.
- [Hof93] H. Hofer, *Pseudoholomorphic curves in symplectizations with applications to the Weinstein conjecture in dimension three*, Invent. Math. **114** (1993), no. 3, 515–563.
- [Hof] ———, *Polyfolds and a general Fredholm theory*. Preprint arXiv:0809.3753.
- [HWZ95] H. Hofer, K. Wysocki, and E. Zehnder, *Properties of pseudo-holomorphic curves in symplectisations. II. Embedding controls and algebraic invariants*, Geom. Funct. Anal. **5** (1995), no. 2, 270–328.
- [HWZ96] ———, *Properties of pseudoholomorphic curves in symplectisations. I. Asymptotics*, Ann. Inst. H. Poincaré Anal. Non Linéaire **13** (1996), no. 3, 337–379.
- [HWZ03] ———, *Finite energy foliations of tight three-spheres and Hamiltonian dynamics*, Ann. of Math. (2) **157** (2003), no. 1, 125–255.
- [HZ94] H. Hofer and E. Zehnder, *Symplectic invariants and Hamiltonian dynamics*, Birkhäuser Verlag, Basel, 1994.
- [HKM] K. Honda, W. H. Kazez, and G. Matic, *Contact structures, sutured Floer homology and TQFT*. Preprint arXiv:0807.2431.
- [Hut02] M. Hutchings, *An index inequality for embedded pseudoholomorphic curves in symplectizations*, J. Eur. Math. Soc. (JEMS) **4** (2002), no. 4, 313–361.

- [Hut10] ———, *Embedded contact homology and its applications*, Proceedings of the International Congress of Mathematicians. Volume II, Hindustan Book Agency, New Delhi, 2010, pp. 1022–1041.
- [HT09] M. Hutchings and C. H. Taubes, *Gluing pseudoholomorphic curves along branched covered cylinders. II*, J. Symplectic Geom. **7** (2009), no. 1, 29–133.
- [Kal] A. Kaloti, *Stein fillings of planar open books*. Preprint arXiv:1311.0208.
- [KL16] A. Kaloti and Y. Li, *Stein fillings of contact 3-manifolds obtained as Legendrian surgeries*, J. Symplectic Geom. **14** (2016), no. 1, 119–147.
- [KM07] P. Kronheimer and T. Mrowka, *Monopoles and three-manifolds*, New Mathematical Monographs, vol. 10, Cambridge University Press, Cambridge, 2007.
- [LW11] J. Latschev and C. Wendl, *Algebraic torsion in contact manifolds*, Geom. Funct. Anal. **21** (2011), no. 5, 1144–1195. With an appendix by Michael Hutchings.
- [LMY17] T.-J. Li, C. Y. Mak, and K. Yasui, *Calabi-Yau caps, uniruled caps and symplectic fillings*, Proc. Lond. Math. Soc. (3) **114** (2017), no. 1, 159–187.
- [Lis98] P. Lisca, *Symplectic fillings and positive scalar curvature*, Geom. Topol. **2** (1998), 103–116 (electronic).
- [Lis08] ———, *On symplectic fillings of lens spaces*, Trans. Amer. Math. Soc. **360** (2008), no. 2, 765–799 (electronic).
- [LVW] S. Lisi, J. Van Horn-Morris, and C. Wendl, *On symplectic fillings of spinal open book decompositions I: Geometric constructions*. Preprint arXiv:1810.12017.
- [Lut77] R. Lutz, *Structures de contact sur les fibrés principaux en cercles de dimension trois*, Ann. Inst. Fourier (Grenoble) **27** (1977), no. 3, ix, 1–15 (French, with English summary).
- [Mas12] P. Massot, *Infinitely many universally tight torsion free contact structures with vanishing Ozsváth-Szabó contact invariants*, Math. Ann. **353** (2012), no. 4, 1351–1376.
- [MNW13] P. Massot, K. Niederkrüger, and C. Wendl, *Weak and strong fillability of higher dimensional contact manifolds*, Invent. Math. **192** (2013), no. 2, 287–373.
- [McD90] D. McDuff, *The structure of rational and ruled symplectic 4-manifolds*, J. Amer. Math. Soc. **3** (1990), no. 3, 679–712.
- [McD91] ———, *Symplectic manifolds with contact type boundaries*, Invent. Math. **103** (1991), no. 3, 651–671.
- [MS04] D. McDuff and D. Salamon, *J-holomorphic curves and symplectic topology*, American Mathematical Society, Providence, RI, 2004.
- [Mor03] E. Mora, *Pseudoholomorphic cylinders in symplectisations*, Ph.D. Thesis, New York University, 2003.
- [Mor18] A. Moreno, *Algebraic torsion in higher-dimensional contact manifolds*, Ph.D. Thesis, Humboldt-Universität zu Berlin, 2018. Preprint arXiv:1711.01562.
- [Mora] ———, *Algebraic and Giroux torsion in higher-dimensional contact manifolds*. Preprint arXiv:1903.11880.
- [Morb] ———, *SFT computations and intersection theory in higher-dimensional contact manifolds*. Preprint arXiv:1903.11884.
- [NW11] K. Niederkrüger and C. Wendl, *Weak symplectic fillings and holomorphic curves*, Ann. Sci. École Norm. Sup. (4) **44** (2011), no. 5, 801–853.
- [OO05] H. Ohta and K. Ono, *Simple singularities and symplectic fillings*, J. Differential Geom. **69** (2005), no. 1, 1–42.
- [OSS05] P. Ozsváth, A. Stipsicz, and Z. Szabó, *Planar open books and Floer homology*, Int. Math. Res. Not. **54** (2005), 3385–3401.
- [Pla12] O. Plamenevskaya, *On Legendrian surgeries between lens spaces*, J. Symplectic Geom. **10** (2012), no. 2, 165–181.
- [PV10] O. Plamenevskaya and J. Van Horn-Morris, *Planar open books, monodromy factorizations and Stein fillings*, Geom. Topol. **14** (2010), 2077–2101 (electronic).
- [SZ92] D. Salamon and E. Zehnder, *Morse theory for periodic solutions of Hamiltonian systems and the Maslov index*, Comm. Pure Appl. Math. **45** (1992), no. 10, 1303–1360.
- [Sch95] M. Schwarz, *Cohomology operations from  $S^1$ -cobordisms in Floer homology*, Ph.D. Thesis, ETH Zürich, 1995.
- [Sco83] P. Scott, *The geometries of 3-manifolds*, Bull. London Math. Soc. **15** (1983), no. 5, 401–487.

- [Sie08] R. Siefring, *Relative asymptotic behavior of pseudoholomorphic half-cylinders*, Comm. Pure Appl. Math. **61** (2008), no. 12, 1631–1684.
- [Sie11] ———, *Intersection theory of punctured pseudoholomorphic curves*, Geom. Topol. **15** (2011), 2351–2457 (electronic).
- [SV17] S. Sivek and J. Van Horn-Morris, *Fillings of unit cotangent bundles*, Math. Ann. **368** (2017), no. 3-4, 1063–1080.
- [Sta15] L. Starkston, *Symplectic fillings of Seifert fibered spaces*, Trans. Amer. Math. Soc. **367** (2015), no. 8, 5971–6016.
- [Tau98] C. H. Taubes, *The structure of pseudo-holomorphic subvarieties for a degenerate almost complex structure and symplectic form on  $S^1 \times B^3$* , Geom. Topol. **2** (1998), 221–332 (electronic).
- [Tau10] ———, *Embedded contact homology and Seiberg-Witten Floer cohomology I*, Geom. Topol. **14** (2010), no. 5, 2497–2581.
- [Thu76] W. P. Thurston, *Some simple examples of symplectic manifolds*, Proc. Amer. Math. Soc. **55** (1976), no. 2, 467–468.
- [TW75] W. P. Thurston and H. E. Winkelnkemper, *On the existence of contact forms*, Proc. Amer. Math. Soc. **52** (1975), 345–347.
- [V07] J. Van Horn-Morris, *Constructions of open book decompositions*, Ph.D. Thesis, University of Texas at Austin, 2007.
- [Wan12] A. Wand, *Mapping class group relations, Stein fillings, and planar open book decompositions*, J. Topol. **5** (2012), no. 1, 1–14.
- [Wen05] C. Wendl, *Finite energy foliations and surgery on transverse links*, Ph.D. Thesis, New York University, 2005.
- [Wen10a] ———, *Compactness for embedded pseudoholomorphic curves in 3-manifolds*, J. Eur. Math. Soc. (JEMS) **12** (2010), no. 2, 313–342.
- [Wen10b] ———, *Automatic transversality and orbifolds of punctured holomorphic curves in dimension four*, Comment. Math. Helv. **85** (2010), no. 2, 347–407.
- [Wen10c] ———, *Strongly fillable contact manifolds and J-holomorphic foliations*, Duke Math. J. **151** (2010), no. 3, 337–384.
- [Wen10d] ———, *Open book decompositions and stable Hamiltonian structures*, Expos. Math. **28** (2010), no. 2, 187–199.
- [Wen13] ———, *A hierarchy of local symplectic filling obstructions for contact 3-manifolds*, Duke Math. J. **162** (2013), no. 12, 2197–2283.
- [Wen18] ———, *Holomorphic curves in low dimensions: from symplectic ruled surfaces to planar contact manifolds*, Lecture Notes in Mathematics, vol. 2216, Springer-Verlag, 2018.
- [Wen20] ———, *Lectures on Contact 3-Manifolds, Holomorphic Curves and Intersection Theory*, Cambridge Tracts in Mathematics, vol. 220, Cambridge University Press, Cambridge, 2020.
- [Wena] ———, *Lectures on holomorphic curves in symplectic and contact geometry*. Preprint arXiv:1011.1690v2.
- [Wenb] ———, *Lectures on Symplectic Field Theory*. Preprint arXiv:1612.01009, to appear in EMS Series of Lectures in Mathematics.

UNIVERSITY OF MISSISSIPPI, DEPARTMENT OF MATHEMATICS, USA

*Email address:* stlisi@olemiss.edu

DEPARTMENT OF MATHEMATICAL SCIENCES, THE UNIVERSITY OF ARKANSAS, USA

*Email address:* jvhm@uark.edu

INSTITUT FÜR MATHEMATIK, HUMBOLDT-UNIVERSITÄT ZU BERLIN, GERMANY

*Email address:* wendl@math.hu-berlin.de